

Remove Watermark Now

The Greatest Lie on Earth
Proof That Our World Is Not a Moving Globe



Edward Hendrie

The Greatest Lie on Earth

Proof That Our World Is Not a Moving Globe

Edward Hendrie

Say among the heathen that the LORD reigneth: the world also shall be established that it shall not be moved: he shall judge the people righteously. (Psalms 96:10)

Keep that which is committed to thy trust, avoiding profane and vain babblings, and oppositions of science falsely so called: Which some professing have erred concerning the faith. Grace be with thee. Amen. (1 Timothy 6:20-21)

Sixth Edition
Copyright © 2016, 2017 by Edward Hendrie
All rights reserved.

Paperback Book ISBN: 978-1-943056-01-9
PDF Ebook ISBN: 978-1-943056-02-6

EdwardHendrie@gmail.com

Other books from Great Mountain Publishing®

- 9/11-Enemies Foreign and Domestic
- Solving the Mystery of BABYLON THE GREAT
- The Anti-Gospel
- Bloody Zion
- What Shall I Do to Inherit Eternal Life?
- Murder, Rape, and Torture in a Catholic Nunnery
- Rome's Responsibility for the Assassination of Abraham Lincoln
- Antichrist: The Beast Revealed

Available at:

www.antichristconspiracy.com

www.lulu.com

www.911enemies.com

www.mysterybabylonthegreat.net

www.antigospel.com

<https://play.google.com>

www.barnesandnoble.com

www.amazon.com

Edward Hendrie rests on the authority of the Holy Bible alone for doctrine. He considers the Holy Bible to be the inspired and inerrant word of God. Favorable citation by Edward Hendrie to an authority outside the Holy Bible on a particular issue should not be interpreted to mean that he agrees with all of the doctrines and beliefs of the cited authority. All Scripture references are to the Authorized (King James) Version of the Holy Bible, unless otherwise indicated.

The water background on the cover is adapted from a photograph by Ramon FVelasquez. File:Dingalanseajf.JPG, <https://commons.wikimedia.org/wiki/File:Dingalanseajf.JPG>. It is used under the Creative Commons Attribution-Share Alike 3.0 Unported license. <https://creativecommons.org/licenses/by-sa/3.0/deed.en>. Use of the photograph should not be interpreted to mean that Ramon Fvelasquez agrees with this author. The remaining cover graphics are from Gleason's New Standard Map of the World.

Table of Contents

Introduction.....	<u>1</u>
1 Samuel Rowbotham Proved the Earth Is Flat.....	<u>18</u>
2 Visibility of Distant Objects Over Water.....	<u>24</u>
3 Water Not Convex Proves Earth Is Not a Globe.	<u>49</u>
4 The Earth Is Flatter Than a Pancake.....	<u>58</u>
5 Mountains of Proof.....	<u>64</u>
6 The Testimony of Buildings and Bridges.....	<u>72</u>
7 Airplane Level Flight Proves the Earth is Flat.	<u>90</u>
8 Horizon Is Always Flat.....	<u>100</u>
9 Flat Horizon is Always At Eye Level.....	<u>106</u>
10 No Coriolis Effect Proves a Stationary Earth.....	<u>120</u>
11 Emergency Landing Evidence of a Flat Earth.	<u>130</u>
12 Simple Proof That Heliocentrism is Impossible.....	<u>141</u>
13 The Testimony of the Stars.....	<u>149</u>
14 Path of Midnight Sun Disproves Heliocentrism.....	<u>153</u>
15 Lunar Eclipses Explained.....	<u>156</u>
16 The Cold Light of the Moon.....	<u>166</u>
17 NASA Pictures of a Spherical Earth.....	<u>172</u>

18	NASA Moon Missions..	<u>201</u>
19	NASA and Freemasonry.	<u>240</u>
20	Media Gatekeepers..	<u>266</u>
21	Map of the Flat Earth..	<u>273</u>
22	What Does the Bible Say?..	<u>286</u>
23	Crushing Gravity.	<u>311</u>
24	Scientific Proof the Earth Does Not Move.	<u>325</u>
25	Einstein to the Rescue.	<u>329</u>
26	Conspiracy.	<u>360</u>
27	Identifying the Conspirators..	<u>364</u>
28	Mind Control.	<u>422</u>
29	The Religion of Modern Cosmology..	<u>457</u>
30	Heliocentric “Christianity”.	<u>517</u>
31	The Inevitable Shills.	<u>538</u>
32	Compromising the Faith.	<u>545</u>
	Endnotes..	<u>567</u>

Introduction

This book reveals the mother of all conspiracies. It will set forth biblical proof and irrefutable evidence that will cause the scales to fall from your eyes and reveal the truth that the world you thought existed is a myth. The book addresses hard facts, not fanciful theories.

An honest man who is shown to be wrong must either admit his error or cease to be honest. There are many so-called scientists and theologians who have made accommodations for falsehood. In order to keep their station in life, they have compromised their integrity and knelt in fealty to mammon and the praise of men.

George Orwell stated that “in a time of universal deceit - telling the truth is a revolutionary act.” We live in such a time. The most universally accepted deceit today is the ingrained teaching that the earth is a globe spinning at a speed of approximately 1,000 miles per hour at the equator, while at the same time orbiting the sun at approximately 67,000 miles per hour. While the earth is orbiting and spinning, the sun, in turn, is supposed to be hurtling through the Milky Way galaxy at approximately 500,000 miles per hour. The Milky Way galaxy is, itself, alleged to be racing through space at a speed ranging from 300,000 to 1,340,000 miles per hour.

What most people are not told is that all of this spinning,

orbiting, and speeding through space, have never been proven. Indeed, those hypothesized movements and speeds are completely made-up. In fact, every scientific experiment that has ever been performed to determine the motion of the earth has proven that the earth is completely stationary. Yet, scientific textbooks ignore the scientific proof that contradicts the myth of an orbiting and spinning Earth.

The “Christian” churches have gone along with the deception and teach in their “Christian” schools a heliocentric solar system, with a spinning and orbiting earth, even though the bible clearly states that the earth does not move and is not a globe. How could this deception have been so complete as to include both the scientific world and the “Christian” churches? Why would the scientific world go along with a falsehood that has been proven to be wrong? Why would the “Christian” churches go along with a myth that is contrary to the bible? This book will explain why and how it happened.

People have been conditioned to have a visceral reaction to any evidence that contradicts the heliocentric model. Such rejection of hard evidence, without a fair hearing, brings folly and shame. “He that answereth a matter before he heareth it, it is folly and shame unto him.” (Proverbs 18:13) This folly and shame is manifested in devilish philosophies that permeate society. The deception of a spherical, spinning earth is the foundation for Darwinian evolution, Freudian psychoanalysis, and Marxist communism. Indeed, the progressive emergence of the sodomite subculture into a government protected privileged class is the direct result of the prevailing theory of heliocentrism (the sun at the center of a solar system). How so?, you ask. It is quite simple. To remove the earth as the center of God’s creation, and accept in its place an earth that is just one of millions of wandering planets in the universe, removes man as God’s unique creation, made in his image. Once the centrality of the earth in God’s creation is removed, it is only a small half-step further to remove the

existence of God himself from the minds of men.

Once God is removed from man's consciousness, then also is removed the authority of God's word and his law. Man is then enthroned, being a law unto himself. The common thread running through heliocentricity, evolution, psychology, and communism is that there is no God. Indeed, atheism is logically a necessary element for each of those man-made philosophies to stand.

The sodomite privileged class springs from a godless generation, with no fear of God. Indeed, they must necessarily reject the God of the bible, because within the bible is found God's condemnation of sodomy. "Thou shalt not lie with mankind, as with womankind: it is abomination." (Leviticus 18:22) That sin is so abhorrent to God that he rained fire and brimstone upon Sodom and Gomorrah as punishment for that filthy sin. "Then the Lord rained upon Sodom and upon Gomorrah brimstone and fire from the Lord out of heaven." Genesis 19:24. Nowadays, however, sodomy is viewed as a protected lifestyle, with the U.S. Supreme Court judging sodomy a good thing, even to the degree of creating a right for same-sex couples to get married. God curses those who call the sin of sodomy good. "Woe unto them that call evil good, and good evil; that put darkness for light, and light for darkness; that put bitter for sweet, and sweet for bitter!" (Isaiah 5:20)

The State and Federal governments in the United States have used the pro-sodomy laws to create a protected class with special government-granted, group privileges, which governments call "civil rights." "Woe unto them that decree unrighteous decrees, and that write grievousness which they have prescribed." (Isaiah 10:1) Those government-granted, group privileges will be used to strike at the God-given, individual rights of Christians. There is no new thing under the sun. God has spoken against such laws contrived to persecute his people. "Shall the throne of iniquity have fellowship with thee, which frameth mischief by a

law? They gather themselves together against the soul of the righteous, and condemn the innocent blood.” (Psalms 94:20-21)

One might ask, how can granting special privileges to a class of sinners infringe on the God-given, individual rights of Christians? Let us look at the example of the Oregon Equality Act of 2007, which is a law that grants special state privileges to sodomites. In 2013, Christians Aaron and Melissa Klein were fined \$135,000 by the Oregon Bureau of Labor and Industries (BOLI) for declining to bake a cake for a lesbian wedding ceremony in violation of the Oregon Equality Act of 2007.¹ The fine was levied after the lesbian couple, Rachel Cryer and Laurel Bowman, filed a civil rights complaint with BOLI against the bakery, “Sweet Cakes by Melissa,” for “emotional, mental, and physical suffering.”² Tod Starnes reported for Fox News how the couple’s small bakery was crushed by the sodomite protests, and as a result they were forced to close their bakery:

The backlash against Aaron and Melissa Klein, owners of the bakery, was severe. Gay rights groups launched protests and pickets outside the family’s store. They threatened wedding vendors who did business with the bakery. And, Klein told me, the family’s children were the targets of death threats. The family eventually had to close their retail shop and now operate the bakery out of their home. They posted a message vowing to stand firm in their faith.³

Melissa Klein stated: “(I) honestly did not mean to hurt anybody, didn't mean to make anybody upset, (it's) just something I believe in very strongly.”⁴ After the Kleins were forced to shut down their bakery, Aaron Klein had to find employment as a trash collector to make financial ends meet. The State of Oregon “frameth mischief by a law” against the soul of the righteous. The Klein case in Oregon is not an anomaly.

Christian liberties are being crushed all over the country. New Mexico's Supreme Court ruled unanimously that two Christian photographers, Elaine and Jonathan Huguenin, who declined to photograph a same-sex union violated the state's Human Rights Act.⁶ The Attorney General of the State of Washington filed a lawsuit against a florist who refused to provide flowers for a same-sex couple's wedding.⁷ Jack Phillips, the owner of Masterpiece Cakeshop in Colorado was ordered by a judge either to serve sodomite couples or face fines.⁸ "When the righteous are in authority, the people rejoice: but when the wicked beareth rule, the people mourn." (Proverbs 29:2)

The promotion and protection of sin acts to degenerate society. One sin begets another sin, as the perversions spiral downward. On July 19, 2016, the U.S. Government announced a new policy of allowing trans-gender persons to serve in the U.S. Military. A new sexual identity military manual states that "[e]ffective immediately, no otherwise qualified service member may be involuntarily separated, discharged or denied re-enlistment or continuation of service, solely on the basis of their gender identity."⁹ The manual goes on to spell out the procedures for service members to obtain sex-change operations at government expense.

The lesbian, gay, bisexual, transgender (a/k/a LGBT) communities have an even more nefarious agenda, which they keep secret from the public at large. Michael Swift's 1987 Gay Manifesto reveals the dirty secret of the LGBT rights movement. The LGBT community wants the right to sodomize children. The Gay Manifesto brazenly states:

We shall sodomize your sons, emblems of your feeble masculinity, of your shallow dreams and vulgar lies. We shall seduce them in your schools, in your dormitories, in your gymnasiums, in your locker rooms, in your sports arenas, in your

seminaries, in your youth groups, in your movie theater bathrooms, in your army bunkhouses, in your truck stops, in your all male clubs, in your houses of Congress, wherever men are with men together. Your sons shall become our minions and do our bidding. They will be recast in our image. They will come to crave and adore us.¹⁰

Former California State Assemblyman Steve Baldwin researched the connection between homosexuality and pederasty. He published his findings in the Spring 2002 Regent University Law Review. Baldwin found that “[s]cientific studies confirm a strong pedophilic predisposition among homosexuals.”¹¹ One 1988 study published in the *Archives of Sexual Behavior*, reported that 86% of pedophiles who victimized boys “described themselves as homosexual or bisexual.”¹² Research statistics further show that homosexuals, as a population, molest children at a rate that is ten to twenty times greater than heterosexuals.¹³ Those facts are well known in the homosexual community. San Francisco’s leading homosexual newspaper, *The Sentinel*, bluntly states that “[t]he love between men and boys is at the foundation of homosexuality.”¹⁴

Homosexual publications openly promote pederasty and are often populated with travel ads for sex tours to Burma, the Philippines, Sri Lanka, Thailand, and other countries infamous for boy prostitution. Baldwin reveals that “[t]he most popular travel guide for homosexuals, Spartacus Gay Guides, is replete with information about where to find boys for sex and, as a friendly warning, lists penalties in various countries for sodomy with boys if caught.”

Baldwin found that “the mainstream homosexual culture commonly promotes sex with children. Homosexual leaders repeatedly argue for the freedom to engage in consensual sex with children.”¹⁵ He determined that one of the principal aims of the

LGBT rights movement is the legalization and promotion of child molestation. Mainstream LGBT organizations such as the International Lesbian and Gay Association (ILGA) and the National Coalition of Gay Organizations have passed many organizational resolutions calling for lowering or eliminating age of sexual consent laws, as a way to legalize pedophilia.¹⁶

The ILGA represents more than 620 member organizations. In 1995, the UN decertified the consultative status of the ILGA as a Non-Government Organization (NGO), because of political pressure from the U.S. Congress, when it was revealed the several member organizations of the ILGA promoted pedophilia. In an effort to get reinstated, ILGA severed ties with the North American Man Boy Love Association (NAMBLA), whose members practice pederasty. Severing ties with NAMBLA was apparently window dressing, since ILGA refused to expel a half-dozen more powerful (and discreet) pro-pedophile groups.¹⁷ The UN has maintained its ban on the consultative status for ILGA.

The rampant pederasty among sodomites is nothing new. And it is the result of the evil spiritual influence that drives the sodomite perversion. For example, Aleister Crowley was a high Freemason and Satanist who styled himself as “The Beast” and proudly proclaimed himself to be “the wickedest man on earth.” Crowley practiced ancient tantric sex magic (a/k/a magick). The core of tantric sex magic is to engage in increasingly cruel and perverse sex acts, gravitating to homosexual acts, and culminating in the rape of a child. The dark masonic secret, known only to the very highest adepts of Freemasonry, is that their way to immortality is to sexually violate a child.¹⁸

That is the purpose behind the granting of government protected privileges to sodomites. That government-protected privilege is only the first step toward the degenerative goal of the evil occultists who control the governments of the world, which is

to legalize sex with children. The powerful elite of the world today secretly engage in all manner of pederasty, which this author details in his book, *Antichrist: The Beast Revealed*.

Sin begets sin. Once a sin is legitimized and protected by the force of government, it begins a downward trajectory, where more sin is legitimized and protected. Such sin creates a violent and chaotic society. This chaos gives rise to new restrictive laws, which ultimately brings about a police state to reestablish order. Under the new police powers granted to the state, the exercise of God-given rights is suppressed by the government.

That is not hyperbole. Former U.S. House of Representatives Majority Leader Tom DeLay revealed in an interview on The Steve Malzberg Show that the U.S. Department of Justice plans to expand the "civil rights" granted by the U.S. Government to include a raft of new perversions, including, but not limited to, bestiality, polygamy, and pedophilia. Those abominable "civil rights" to rape children, have polygamous marriages, and have sex with animals will be used as a lever to persecute Christians who exercise their God-given rights, object to those sins, and seek to protect the children. The U.S. Justice Department has been busy strategizing on how to use the force of government to persecute recalcitrant Christians.

Former U.S. House Majority Leader Tom DeLay claims the Justice Department has drafted a memo that spells out a dozen "perversions," including bestiality and pedophilia, that it wants legalized.

"We've ... found a secret memo coming out of the Justice Department. They're now going to go after 12 new perversions. Things like bestiality, polygamy, having sex with little boys and making that legal," DeLay said Tuesday on "The Steve Malzberg Show" on Newsmax TV.

"Not only that, but they have a whole list of strategies to go after the churches, the pastors and any businesses that try to assert their religious liberty. This is coming and it's coming like a tidal wave."

The Texas Republican's bombshell claim comes four days after the Supreme Court ruled that same-sex marriage is now legal in all 50 states — a landmark decision DeLay strongly opposes.

When Steve Malzberg repeated to DeLay his assertions that the Justice Department seeks "to legitimize or legalize" practices such as bestiality — defined as sex acts between humans and animals — DeLay responded:

"That's correct, that's correct. They're coming down with 12 new perversions ... LGBT [short for lesbian gay, bisexual and transgender] is only the beginning. They're going to start expanding it to the other perversions."¹⁹ (bracketed parenthetical in original article)

Satan knows that if man cuts loose his passions without regard to the laws of God, the sinful conduct will necessitate a tyrannical government. How so? The escalating sin is in essence an encroachment upon the God-given rights of another. Jesus explained the concept:

Jesus said unto him, Thou shalt love the Lord thy God with all thy heart, and with all thy soul, and with all thy mind. This is the first and great commandment. And the second is like unto it, Thou shalt love thy neighbour as thyself. On these

two commandments hang all the law and the prophets. (Matthew 22:37-40)

The love that Jesus speaks of is not an emotional feeling toward another as Hollywood movies would have you believe. Emotions come and go. Love is not an emotion, it is an action. Jesus explained: that “as ye would that men should do to you, do ye also to them likewise.” (Luke 6:31). Indeed, doing good for another person has nothing at all to do with how you feel about that person. Jesus stated that you should do good to even your enemies who have treated you badly. Luke 6:27-36. God’s word has a built in dictionary where words are defined by the use of parallelism. One can see in Luke chapter 6 at verses 32 and 33 that God uses parallelism to define love, not as a feeling, but rather as an action of “doing good” to another person.

“For if ye **love** them which **love** you, what thank have ye? for sinners also **love** those that **love** them.” (Luke 6:32)

“And if ye **do good** to them which **do good** to you, what thank have ye? for sinners also do even **the same**.” (Luke 6:33)

Doing good to another is not just a suggestion, it is a command from God. Jesus states without equivocation that all of the commands of God are subsumed in the commands to love God and love your neighbor. Love has nothing to do with feelings. You should do nice things for others, whether you “feel” like it or not, because by doing so you are obeying God’s command to do good to others. If one loves his neighbor, he will not violate the command, “thou shalt not steal.” Exodus 20:15. While the command not to steal is a prohibition, Jesus takes it a step further and commands that we are to affirmatively do good to others (i.e., love).

Doing good often involves putting our needs second to the needs of another. If, however, a person does not regard God and

seeks to satisfy the pleasure of his fleshly desires, without regard to the detrimental effect of his conduct on others, it will cause the government to step in to protect the aggrieved party. Sinful behavior brings about more crime in society, which is then used as a justification to bring about more government regulation and control of the masses. As explained by Edmond Burke: “Men are qualified for civil liberty in exact proportion to their disposition to put moral chains on their own appetites. Society cannot exist unless a controlling power upon will and appetite be placed somewhere, and the less of it there is within, the more there is without. It is ordained in the eternal constitution of things that men of intemperate minds cannot be free. Their passions forge their fetters.”

That is why Satan wants to drive any thought of God from the minds of men. Indeed, by doing so, a satanically controlled government can impose its tyranny on the people, without much objection from the people, because the people are ignorant that the fetters applied by the government violate the laws of God. For example, the communist collective ideal is based upon larceny. It uses the government to redistribute wealth. The redistribution of wealth is always justified by some purported need, and it usually involves helping children; it is always cloaked in nice sounding labels, like “welfare.” There are always powerful corporate interests that are lined up to be on the receiving end of the government forced transaction.

Rather than charity coming willingly from one individual to another, the government uses its force, through taxation, to take money from one group and give it to another. Taking money from one group and giving it to another group cannot be done if the government accepted the existence of God. If God were to be accepted, then necessarily God’s commands must be then obeyed. The government would have a hard time justifying taking money from one group of persons for the benefit of another group of persons, when faced with God’s command: “Thou shalt not steal.”

(Exodus 20:15) Using the government as an intermediary does not make the stealing any more justifiable.

Like communism, Darwinian evolution is necessarily atheistic and cannot stand if the authority of the bible is accepted. The bible makes it clear that God created man in his image, not after the image of an ape. “So God created man in his own image, in the image of God created he him; male and female created he them.” (Genesis 1:27)

Heliocentrism destroyed the landmark of geocentrism. Heliocentrism laid the groundwork for Darwinism. Once Darwinian evolution settled in, it was time for the planting of Marxist communism. In 1860 Karl Marx stated the following about Darwin’s book, *On the Origin of Species*, which announced the theory of evolution: “Although it is developed in the crude English style, this is a book which contains the basis of natural history for our views.”²⁰

After allowing the theory of evolution to ferment in his mind for the next 7 years, in 1867, Marx brought forth to the world his economic philosophy, based upon godless Darwinism, titled *Das Kapital*. Marx sent a copy of his new book to Charles Darwin inscribed with the following: “To Charles Darwin from a devoted admirer, Karl Marx, 1873.”



In October, 1873, Charles Darwin wrote to Karl Marx the following letter of thank you for the inscribed book sent to him by Marx:

Dear Sir:

I thank you for the honour which you have done me by sending me your great work on Capital; & I heartily wish that I was more worthy to receive it, by understanding more of the deep and important subject of political Economy. Though our studies have been so different, I believe that we both

earnestly desire the extension of Knowledge, &
that this is in the long run sure to add to the
happiness of Mankind.

I remain, Dear Sir
Yours faithfully,

Charles Darwin

The synergism between Darwin's godless evolution and Marx's godless communism is evidenced by the fact that in 1959 the communist regime in the Soviet Union struck a coin and printed a stamp²¹ in honor of the 150th anniversary of Darwin's birth (1809).



Sigmund Freud based his theories of psychoanalysis on the premise that there is no God. In his *The Future of an Illusion*, he described belief in God as a collective neurosis: he called it "longing for a father."²² Psychology is essentially religion without God. Like all man-made religions, there are schisms. There are over 200 different theories of psychology (Freudian psychoanalysis being only one of them).

Heliocentrism is truly the mother of all conspiracies. None of the other Satan-inspired, man-made philosophies would ever

dare be presented without the geocentric landmark first being removed by the general acceptance of heliocentrism. Heliocentrism is the keystone to the deception; remove that keystone, and the entire edifice of deception will fall. With that keystone in place, the satanic source of the deception is inscrutable, and the facade of scientific authority for the satanic philosophies remains believable.

The educational authorities use a tried and true method of conditioning students to reject true scientific evidence and instead accept the myth of heliocentricity. William Poole explained this stratagem. “There is a principle which is a bar against all information, which is proof against all argument, and which cannot fail to keep a man in everlasting ignorance. This principle is, contempt prior to examination.” Satan has used this method to keep people in a state of nescience about God’s creation. He has created a hive mentality instilled at the earliest stages of education that protects the myth of heliocentricity. Anyone who questions the legitimacy of heliocentricity has his character attacked by the hive as being ignorant. The evidence for a stationary, flat earth, no matter its validity, will be dismissed without examination. Thus the hive is kept in “everlasting ignorance.”

The importance of heliocentrism to Satan’s plan for world domination is why it is introduced at the earliest stage possible in the education of students. From the first day in government schools, the foundational scientific truth presented to a student is a globe of the earth that can spin on a pedestal. Heliocentrism is repeatedly reinforced throughout a student’s scientific education. Heliocentrism is the most glaring example of mass mind control. To control the masses, heliocentrism must be introduced early and often, so that it becomes a deeply ingrained belief. While at the same time, belief in a stationary, flat earth is always portrayed by the educational authorities as evidence of abject ignorance.

Each of the satanic philosophies of the world

(heliocentrism, communism, evolution, psychology) are necessary cogs in the New World Order, which is an ancient trans-generational conspiracy. There is nothing new about the New World Order. The New World Order conspiracy is a conspiracy against God and man; it began in heaven and continues today on earth.

And there was war in heaven: Michael and his angels fought against the dragon; and the dragon fought and his angels, And prevailed not; neither was their place found any more in heaven. And the great dragon was cast out, that old serpent, called the Devil, and Satan, which deceiveth the whole world: he was cast out into the earth, and his angels were cast out with him.” (Revelation 12:7-9)

Satan was cast out of heaven. He then gathered with his minions on earth and began his war against God and man anew.

And when the dragon saw that he was cast unto the earth, he persecuted the woman which brought forth the man child. ... And the dragon was wroth with the woman, and went to make war with the remnant of her seed, which keep the commandments of God, and have the testimony of Jesus Christ. (Revelation 12:13,17)

The target of Satan’s malevolence is the true church of Jesus Christ. Satan has a secret army of devil possessed adversaries of Christ who do Satan’s bidding in working to suppress the gospel of Jesus Christ and enslave the world. In order to achieve those ends, Satan must control the minds of the masses. He must enslave our minds, before he can enslave our bodies. Heliocentrism is the foundational belief for enslaving the minds of men.

Satan's goal is a world government under his control, his minions call it a New World Order. One of Satan's minions is President George H.W. Bush. In his January 29, 1991, State of the Union speech before a Joint Session of Congress, President Bush brazenly announced his efforts toward achieving a New World Order. "What is at stake is more than one small country, it is a big idea, a New World Order, where diverse nations are drawn together in common cause."²³

Isa Blagden stated that "if a lie is only printed often enough, it becomes a quasi-truth, and if such a truth is repeated often enough, it becomes an article of belief, a dogma, and men will die for it."²⁴ Heliocentrism has become the dogma of our world today. The purpose of the heliocentric model is to hide the existence of God. This book will not only prove that heliocentrism is false; it will go further and prove that God created a stationary, flat earth that is the center of his creation, just as stated in the bible. You will come to understand that God is real, and he is watching.

1 Samuel Rowbotham Proved the Earth Is Flat

Evidence that the earth is flat is all around us. For example, if the earth were round, then the curvature of the earth would be manifested in the physical landscape. But we do not see any curvature of the earth. The earth's circumference is purported to be 24,901 miles at the equator. That means that the horizon should drop from sight at the rate of 8 inches per mile distance squared. Samuel Birley Rowbotham (1816–1884), who went by the *nom de plume* of “Parallax,” in 1881 explained the principle in his book, *Zetetic Astronomy, Earth Not a Globe*,

If the earth is a globe, and is 25,000 English statute miles in circumference, the surface of all standing water must have a certain degree of convexity--every part must be an arc of a circle. From the summit of any such arc there will exist a curvature or declination of 8 inches in the first statute mile. In the second mile the fall will be 32 inches; in the third mile, 72 inches, or 6 feet, as shown in the following diagram.²⁵

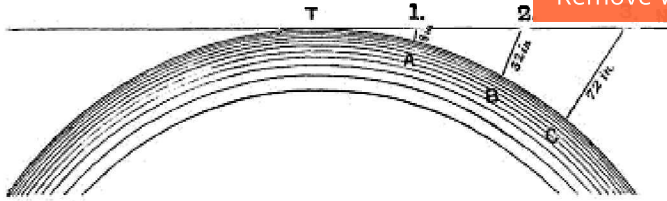

In Cambridge County, England there is an artificial canal, called the "Old Bedford." It is approximately twenty miles in length. Rowbotham arranged to have a boat, with a flag on it that was exactly 5 feet above the surface of the water. The boat was rowed to Welney Bridge, which was exactly six statute miles in a straight line from Rowbotham, who had waded into the water. Rowbotham stood in the middle of the canal with a telescope exactly 8 inches above the surface of the water. In looking through the eyepiece of the telescope and observed the receding boat during the whole period required to sail to Welney Bridge. "The flag and the boat were distinctly visible throughout the whole distance!"²⁶

If the earth were round, as it is supposed, the flag should not have been visible to Rowbotham. The boat and flag should have been 11 feet 8 inches below the horizon as depicted in the diagram below.

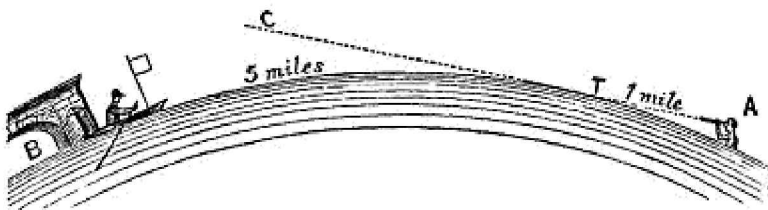

Rowbotham explains the depiction in the diagram above: "Let A B represent the arc of water 6 miles long, and A C the line of sight. The point of contact with the arc would be at T, a distance

of one mile from the observer at A. From T to the bridge at B would be 5 miles, and the curvature from T to B would be 16 feet 8 inches. The top of the flag on the boat (which was 5 feet high) would have been 11 feet 8 inches below the horizon T, and altogether out of sight. Such a condition was not observed.”²⁷

Rowbotham was able to see the flag and boat for the entire 6 mile journey in the canal, all the way to the bridge, as depicted in the diagram below.

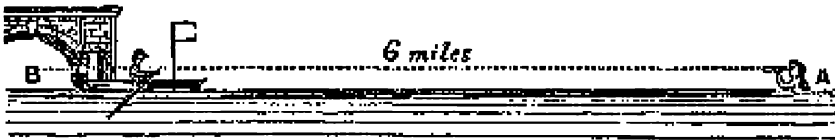

The fact that Rowbotham was able to see the flag and boat for the entire 6 miles, proves that the earth is flat. Rowbotham did many similar experiments at the canal that all proved that there was no curvature of the earth.

The formula for the expected drop per mile is $M^2 \times 8 = D$, where “M” is the number of miles from the observer at ground level, “8” is the number of inches dropped per mile squared, and “D” is the distance of the drop over the horizon. The above equation assumes an earth with a circumference of 24,901 miles.

The validity of the formula $M^2 \times 8 = D$ can be verified by using the Pythagorean theorem. Under the Pythagorean theorem the length of any side of a right triangle can be determined if one knows the length of the other two sides. The formula for the Pythagorean theorem is $a^2 + b^2 = c^2$, where a, b, and c are the three sides of a right triangle.

In the graphic below, this author used the Pythagorean

theorem to determine the drop below the horizon at a distance of 50 miles. The answer using the Pythagorean theorem is exactly the same answer through the formula of $M^2 \times 8 = D$. To find the drop from the horizon at a distance of 50 miles we would take the miles squared multiplied times 8 inches per our formula above, $M^2 \times 8 = D$. Assuming a 50 mile distance, we get $50^2 \times 8 = 20,000$ inches (1,666 feet). Converting the 20,000 inches (1,666 feet) to miles, we get a drop of .32 miles.

The radius of the earth is determined to be 3,963 miles. The radius of the earth is determined through the formula of $R = C \div (2 \times \pi)$ where “ π ” is 3.14159, “R” is the radius, and “C” is the circumference. The number “ π ” is a mathematical constant that is based upon the ratio of a circle’s circumference to its diameter. To arrive at π , simply divide a circle’s circumference by its diameter. All circles, no matter their size, have the same ratio of their circumference to their diameter of 3.14159. π is an irrational number that never ends. 3.14159 only carries π out to the fifth decimal place, but it in fact continues indefinitely.

If the circumference of the earth at the equator is taken to be as alleged, 24,901 miles, that would mean that the earth’s radius is $24,901 \div (3.14159 \times 2) = 3,963$ miles. For some reason, the alleged radius of the earth is published by many authorities to be 3,959 miles. That, however, cannot be correct, according to the geometric equation for determining the radius of a circle. This author will use the figure of 3,963 miles obtained from the equation for the radius of the earth. The difference of four miles between the two figures does not make a material difference in our conclusions.

Using the Pythagorean theorem ($a^2 + b^2 = c^2$) we can easily determine the length of the hypotenuse (side “c”). Side “a” is the radius of the earth (3,963 miles), side “b” is 50 miles, which means that side “c” is 3,963.32 miles. If we subtract the length of the hypotenuse (side “c”) from the known radius of the earth, we

can confirm that the drop below the horizon at a distance of 50 miles from a supposedly globular earth is .32 miles. That is the exact same figure we obtained using the formula $M^2 \times 8 = D$, thus confirming the validity of that formula.

Using two separate formulae to compute the distance of drop below the horizon at 50 miles, assuming a round earth with a circumference of 24,901 miles and a radius of 3,963 miles.

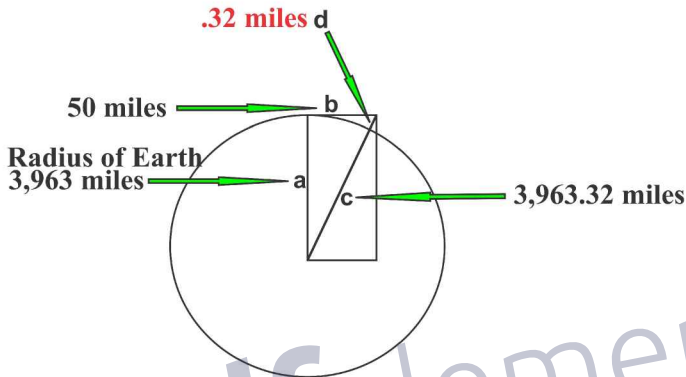

$$a^2 + b^2 = c^2$$

$$\sqrt{a^2 + b^2} = c$$

$$\sqrt{(3,963 \times 3963) + (50 \times 50)} = 3,963.32$$

$$c - \text{radius} = d$$

$$3,963.32 - 3,963 = .32 \text{ miles}$$

$\text{Miles}^2 \times 8 \text{ inches} = \text{drop}$

$50 \text{ miles} \times 50 \text{ miles} \times 8 \text{ inches} = 20,000 \text{ inches} = .32 \text{ miles}$

Below is a chart that gives the results of the equation ($M^2 \times 8 = D$) for the expected drop per mile assuming an earth with a circumference of 24,901 miles. “M” is the number of miles from the observer at ground level, “8” is the number of inches dropped per mile squared, and “D” is the distance of the drop over the horizon.

Statute Miles	Drop Below Horizon Due to Earth's Supposed Curvature
1	8 inches
2	32 inches
3	6 feet
4	10 feet
5	16 feet
6	24 feet
7	32 feet
8	42 feet
9	54 feet
10	66 feet
20	266 feet
30	600 feet
40	1,066 feet
50	1,666 feet
60	2,400 feet
70	3,266 feet
80	4,266 feet
90	5,400 feet (1.02 miles)
100	6,666 feet (1.26 miles)
120	9,600 feet (1.82 miles)

2 Visibility of Distant Objects Over Water

If, in fact, the earth were a round ball as is supposed, there is simply no way to explain how lighthouses can be seen from such great distances at sea. This phenomenon can be experienced by modern mariners today. The only interpretation of the phenomenon of being able to see lighthouses and other structures many miles out at sea is that the earth is flat. Rowbotham gave a series of examples of lighthouses that could, in fact, be seen at great distances. Those lighthouses should have been well below the level curvature of the earth and thus out sight if the earth were round.

The Egerö Light, on west point of Island, south coast of Norway, is fitted up with the first order of the dioptric lights, is visible 28 statute miles, and the altitude above high water is 154 feet. On making the proper calculation it will be found that this light ought to be sunk below the horizon 230 feet.

The Dunkerque Light, on the south coast of France, is 194 feet high, and is visible 28 statute miles. The ordinary calculation shows that it ought to be 190 feet below the horizon.

The Cordonan Light, on the River Gironde, west coast of France, is visible 31 statute miles, and its altitude is 207 feet, which would give its depression below the horizon as nearly 280 feet.

The Light at Madras, on the Esplanade, is 132 feet high, and is visible 28 statute miles, at which distance it ought to be beneath the horizon more than 250 feet.

The Port Nicholson Light, in New Zealand (erected in 1859), is visible 35 statute miles, the altitude being 420 feet above high water. If the water is convex it ought to be 220 feet below the horizon.

The Light on Cape Bonavista, Newfoundland, is 150 feet above high water, and is visible 35 statute miles. These figures will give, on calculating for the earth's rotundity, 491 feet as the distance it should be sunk below the sea horizon.²⁸

Rowbotham used standard, readily available authorities to prove that the earth is a flat plane. For example, he cites many instances in the authoritative text of its time on lighthouses, *Lighthouses of the World*, by Alexander G. Findlay (1861). Findlay was an internationally renowned geographer and hydrographer, who wrote many reference guides, which were invaluable to mariners throughout the world. Findlay had unquestioned competence in hydrography. Mariners relied upon the accuracy of his *Lighthouses of the World* reference guide. Indeed, it was imperative that the entries in that reference book be precise, as the very lives of the mariners rested on the accuracy of the information in that text. While the text was certainly accurate, Rowbotham demonstrated that many of the lighthouses should not have been visible from the distances listed in that text if the earth were a globe. The only rational conclusion is that the earth is a flat

plane. One example Rowbotham cites from page 39 of *Lighthouses of the World* is the Bidston Lighthouse.

By the same authority, at page 39, the Bidston Hill Lighthouse, near Liverpool, is 228 feet above high water, one bright fixed light, visible 23 nautical or very nearly 27 statute miles. Deducting 4 miles for the height of the observer [10 feet above the water], squaring the remaining 23 miles and multiplying that product by 8 inches we have a downward curvature of 352 feet; from this deduct the altitude of the light, 228 feet, and there remains 124 feet as the distance which the light should be below the horizon!²⁹



Bidston Lighthouse.

Above is a sketch of Bidston Lighthouse, from *Sailing Directions from Point Lynas to Liverpool*. The Bidston Lighthouse was replaced in 1873 with a new lighthouse built nearby. Below is a photocopy extract of the page in the book, *Lighthouses of the*

World, which Rowbotham cited.

ENGLAND.		LIGHTHOUSES.		West Coast.		39
Name and Character of Light.	Lat. N. Long. W.	Description, &c.	Description of Apparatus	Height above H. W.	Visible in Miles.	Year established.
HOYLAKE Two br. fixed lights	53 23.7 3 10.7	In one, S.W. by S., 1,200 feet apart, near the Church	●	55 31	13 11	1763
BIDSTON One bright fixed light	53 24. 3 4.4	A stone tower, 68 feet high, on the hill	●	228	23	1771
LEASOWE One bright fixed light	53 24.8 3 7.5	On the shore, between the Mer- sey and Dee	●	94	14	1763
BLACK ROCK One rev. lt. 1 minute br. twice; red once	53 26.6 3 2.	A white tower, 94 ft. high. Also a <i>fixed light</i> , while 11 ft., down Rock Channel and up Mersey	●	61	14	1830

Please note that Findlay explained that the distance at which a lighthouse could be seen given in his book as “the minimum distance to which the light can be seen, in clear weather, from a height of 10 feet above the sea level.”³⁰ Since Findlay is giving the minimum distance in clear weather, that means that in clear weather the lighthouse could potentially be seen from further than the listed distance. Furthermore, the listed distances assume clear weather. If the weather was not clear, due to humidity or other causes, then the distance from which a lighthouse could be seen, would, of course, be shorter.

Rowbotham illustrated an example where passengers on a ship in St. George’s Channel could see the lighthouses on each shore at the same time from the middle of the channel. The lighthouses were separated by a total distance of 60 miles, which put each lighthouse 30 miles from the ship going down the center of the channel. Such a phenomenon would be impossible if the earth were a globe. Rowbotham explains:

The distance across St. George's Channel, between Holyhead and Kingstown Harbour, near Dublin, is at least 60 statute miles. It is not an uncommon thing for passengers to notice, when in, and for a

considerable distance beyond the centre of the Channel, the Light on Holyhead Pier, and the Poolbeg Light in Dublin Bay, [as shown in the diagram below].³¹



If the earth were a globe, however, the lighthouses could not have been seen at all. Indeed, due to the curvature of the supposed globular earth, at the distance of 30 miles each from the ship, and even subtracting for the height of the observer above the water, each lighthouse would be over 300 feet below the horizon. Rowbotham explains:

The Lighthouse on Holyhead Pier shows a red light at an elevation of 44 feet above high water; and the Poolbeg Lighthouse exhibits two bright lights at an altitude of 68 feet; so that a vessel in the middle of the Channel would be 30 miles from each light; and allowing the observer to be on deck, and 24 feet above the water, the horizon on a globe would be 6 miles away. Deducting 6 miles from 30, the distance from the horizon to Holyhead, on the one hand, and to Dublin Bay on the other, would be 24 miles. The square of 24, multiplied by 8 inches, shows a declination of 384 feet. The altitude of the lights in Poolbeg Lighthouse is 68 feet; and of the red light on Holyhead Pier, 44 feet. Hence, if the earth were a globe, the former would always be 316 feet and the latter 340 feet below the horizon, as seen in the following diagram The line of sight H, S, would be a tangent touching the horizon at H, and passing more than 300 feet over the top

of each lighthouse.³²



Evolutionist Robert Schadewald, who believes that the world is a sphere, tried to refute Rowbotham's findings. Schadewald quoted Rowbotham's book, *Zetetic Astronomy*, regarding his calculations for the Ryde Pier Lighthouse:

This conclusion [that the Earth is flat] is greatly confirmed by the experience of mariners in regard to certain lighthouses. Where the light is fixed and very brilliant it can be seen at a distance, which the present doctrine of the Earth's rotundity would render altogether impossible. For instance, at page 35 of "Lighthouses of the World," the Ryde Pier Light, erected in 1852, is described as a bright fixed light, 21 feet above high water, and visible from an altitude of 10 feet at the distance of 12 nautical or 14 statute miles. The altitude of 10 feet would place the horizon at the distance of 4 statute miles from the observer. The square of the remaining 10 statute miles will give a fall or curvature downwards from the horizon of 66 feet. Deduct from this 21 feet, the altitude of the light, and we have 45 feet as the amount which the light ought to be below the horizon!³³

What did the skeptic, Schadewald, conclude regarding Rowbotham's findings? He examined Rowbotham's calculations and found that Rowbotham's was absolutely correct. Schadewald tried to introduce refraction of light as the explanation for the

visibility of the Ryde Pier Lighthouse. However, his refraction theory did not explain what was observed regarding the visibility of the lighthouse that should have been below the horizon on a spherical earth. Schadewald was left scratching his head.

Rowbotham's calculation is correct, although he made no allowance for atmospheric refraction. But even deducting $1/7$ of the dip for refraction (a generous correction) does not solve the problem for sphericity.³⁴

Schadewald scrutinized Rowbotham's findings regarding the Bidston Hill Lighthouse, discussed above. Once again, Schadewald had to admit that Rowbotham was correct. Schadewald's attempt to explain Rowbotham's results by introducing atmospheric refraction again failed to account for the visibility of the lighthouses.

Again, Rowbotham's arithmetic is correct, and even a generous correction for atmospheric refraction cannot solve the problem for sphericity. Rowbotham gave about 20 such examples in *Zetetic Astronomy*, and he averred that "many other cases could be given from the same work, shewing that the practical observations of mariners, engineers, and surveyors entirely ignore the doctrine that the earth is a globe."

Suspicious reader that you are, you probably wonder whether Rowbotham cited *Lighthouses of the World* correctly. Bresher wondered, too. When he consulted the work, however, he found that the published numbers were exactly as Rowbotham stated them.³⁵

Although the visibility of the lighthouses proved the earth

was flat, Schadewald still did not accept Rowbotham's conclusion. Schadewald was left arguing that Rowbotham cherry picked lighthouses from Findlay's *Lighthouses of the World* that could be seen, which otherwise should have been below the horizon and invisible. He argued that most of the lighthouses could be seen both on a spherical and a flat earth. He, therefore, dismissed those lighthouses that should have been out of sight, below the horizon on a spherical earth, as "anomalies." Shadewald stated:

This technique is the common property of those determined to convince others of their position by whatever methods they find expedient. Thus, many creationist evangelists comb the scientific literature trying to find things that don't seem to fit the conventional view. Then they present these anomalies to the public as representative, just as Rowbotham presented his anomalous lighthouses. Looking for lighthouses is, of course, easier than trying to construct a creation model. Despite assertions to the contrary, no predictive "creation model" of the biological world exists.³⁶

Schadewald criticizes Rowbotham for pointing to proof of a flat earth through lighthouses that should be invisible on a globular earth, by arguing that he could only cite 20 examples. Schadewald misses the point. Those 20 lighthouses existed and Schadewald does not dispute that they were visible, just as claimed by Rowbotham. How does he address those facts? He doesn't. His explanation is a shrug of the shoulders: "Beats me." He then engages in conjecture that "perhaps" the lighthouses were observed under unusual conditions, or "perhaps" new observations may not confirm the published observations. That is not science, that is conjecture. Indeed, Schadewald knows that neither of those things could be true, because at the time Rowbotham published his book, there were many trying to refute his claims. His opponents could easily have established whether the lighthouses were not

visible at the listed distances. Schadewald even cites to one such man, M. R. Bresher, who in fact had to admit to the accuracy of Rowbotham's lighthouse data. Schadewald's conclusion sounds like a man who has stumbled across the truth, yet gets up, dusts himself off, and continues on his journey, without a thought of what just happened.

And what about Rowbotham's anomalous lighthouses? Beats me. Perhaps the reported observations were made under unusual conditions. Perhaps, for those lighthouses still operating, new observations would not confirm the reported anomalies. By now, however, some of Rowbotham's lighthouses presumably have been closed, torn down, or destroyed by the elements. For these, we will never know. One thing is certain; those who seek only anomalous lighthouses will never find light.³⁷

While many of the lighthouses have been closed down, there are many other lighthouses that still stand today as silent sentinels proving that the earth is flat. For example, the Bell Rock Lighthouse is still in use today.³⁸ It is the oldest lighthouse in the British Isles and is an engineering marvel that has saved countless ships and lives. The lighthouse is built on a submerged reef, approximately 10 miles out to sea, off the east coast of Scotland. The difficulty in constructing a lighthouse in an area of such stormy seas moved the BBC to describe it as one of the seven wonders of the industrial age. It was first lit in 1811. It is the oldest surviving sea washed lighthouse in the world.

According to Alexander Findlay's authoritative reference guide, *Lighthouses of the World*³⁹, the Bell Rock Lighthouse is 90 feet above the high water mark of the sea and it can be seen at sea by ships for a distance of 14 nautical miles (which is a little more than 16 statute miles). Please note, again, that Findlay listed "the

minimum distance” at which the lighthouse could be seen, in clear weather, from a height of 10 feet above the water.⁴⁰

If the earth were a globe, a mariner on a ship at sea would not be able to see that light from a distance of 16 statute miles. Squaring the miles and multiplying by 8 inches for the curve of the earth, and making an allowance for the fact that a mariner would be approximately 10 feet above the water, we find that the light at the top of the lighthouse would be approximately 6 feet below the horizon if the earth were a globe. We know, however, that mariners can see the lighthouse in clear weather from a “minimum” distance of 16 statute miles. Only on a flat earth, could a mariner on the deck of a ship see the Bell Rock lighthouse from 16 statute miles away. That minimum viewing distance in clear weather for the Bell Rock Lighthouse is unattainable on a globular earth.



Figure 13: Bell Rock Lighthouse

Another example of a functioning lighthouse that stands as a sentinel proving that the earth is flat is the Fourteen Foot Bank Lighthouse. That lighthouse is built 12 miles off of Bowers Beach in the middle of Delaware Bay.⁴¹ The lighthouse is 59 feet above

the sea and can be seen by ships at sea from a distance of 14 statute miles (12 nautical miles).⁴² If the earth were a globe, a mariner on a ship at sea would not be able to see that light from a distance of 14 statute miles. Squaring the statute miles and multiplying by 8 inches for the curve of the earth, and making an allowance for the fact that a mariner would be approximately 10 feet above the water, we find that the light would be approximately 8 feet below the horizon if the earth were a globe. We know, however, that mariners can see the lighthouse from a distance of 14 statute miles. The New Jersey Lighthouse Society explains that “[i]t is 59 feet to the focal plane of the light. The lighthouse is still in operation and described on current nautical charts as ‘GP Fl (2) 20 sec. 50 ft. [sic] 12 m Horn,’ which indicate[s] to mariners that the light is a group flashing light (2), every 20 seconds on a 59 foot tower, visible 12 nautical miles [14 statute miles] at sea and that the station is equipped with a fog horn.”⁴³ Only on a flat earth, could a mariner on the deck of a ship see the Fourteen Foot Bank Lighthouse 14 statute miles away.

The evidence of a flat earth is everywhere to be seen. Rowbotham’s experiments can be replicated very easily today. For example, in the photograph below, the Chicago skyline can be seen clearly. The picture was taken by Joshua Nowicki as he stood at Grand Mere Park, Michigan, which is approximately 57 miles away, across lake Michigan from Chicago.⁴⁴



Figure 14: Photograph of Chicago taken by Joshua Nowicki, as he stood at Grand Mere Park, Michigan, 57 miles away.

If the earth were a globe Chicago would be below the horizon. The only way that Chicago could be seen from the western shore of Michigan is if the world is flat. Below is a map showing the 57 mile distance across lake Michigan from Grand Mere Park, Michigan to Chicago, Illinois.

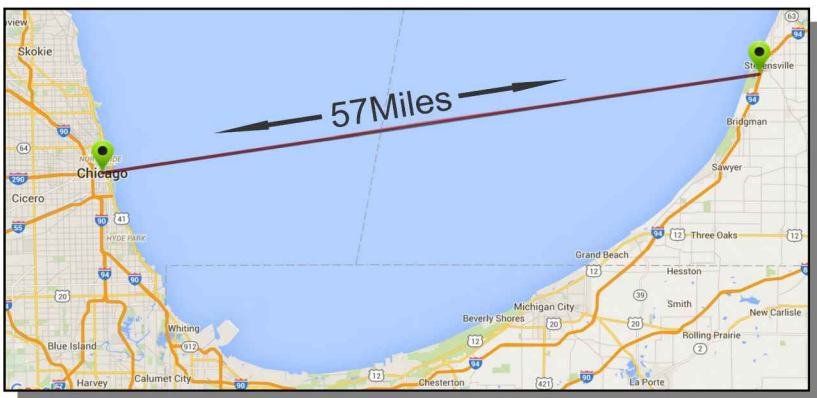

Let us calculate the position of Chicago in relation to Grand Mere Park, assuming that the earth were a globe. Grand Mere Park is 600 feet above sea level. Lake Michigan is 577 feet above sea level. Therefore, Grand Mere Park is 23 feet above Lake Michigan ($600 - 577 = 23$). Let's assume that the photographer was at the highest point in Grand Mere Park. We will add six feet for the height of the photographer. We come up with an estimate that the camera was, at most, 29 feet above the level of the water on Lake Michigan ($23 + 6 = 29$). We will subtract seven miles from the distance of 57 miles to account for the 29 foot elevation of the camera above Lake Michigan (29 foot drop to horizon = approximately 6.6 miles, which is rounded up to 7 miles) ($29 \text{ feet} = 6.6^2 \times 8 \text{ inches}$).

Calculating the curvature of the earth using the 50 mile distance, we find that the street level of Chicago should be 1,644 feet below the horizon. The tallest building in the picture is the Sears Tower (it has been recently renamed the Willis Tower). The Sears Tower was, from 1974 to 1998, the tallest building in the world. It stands 1,450 feet above the street. However, the antennae on top of the tower brings the total height to 1,729 feet above the street level.

In coming up with the 1,644 feet drop below the horizon, it must be understood that it was necessary to subtract 23 feet from the total drop of 1,667 feet ($50^2 \times 8 \text{ inches} = 1,667 \text{ feet}$) to account for the fact that the Sears Tower is 23 feet above the level of Lake Michigan. The Sears Tower is 595 feet above sea level. Lake Michigan is 577 feet above sea level. That puts the Sears Tower 23 feet above Lake Michigan. Therefore, the base of the Sears Tower would be 1,644 feet below the horizon ($1,667 - 23 = 1644$). That means that if the earth were a globe, none of the buildings, including the Sears Tower, would be visible. They would all be below the horizon. The top of the Sears Tower would be 194 feet below the horizon ($1,644 - 1,450 = 194$). The only thing that would be visible in the entire Chicago skyline would be the

uppermost 85 feet of the antennae on the top of the Sears Tower.

In fact, however, the entire Sears Tower and all of the other buildings along the shore in Chicago can be seen in the Nowicki photograph. That picture by Joshua Nowicki of the Chicago skyline proves that the earth is flat.



Figure 16

Sears Tower, indicating the height of the tower and where it would be in relation to the horizon when viewed from 57 miles away across Lake Michigan if the earth were a globe.

Joshua Nowicki's photograph created such a sensation that it was necessary for the media powers to explain how Chicago could be seen from the Michigan shore, 57 miles away, which is an impossibility if the earth were a globe. Tom Coomes, a weatherman for ABC News argued that it was impossible to actually see Chicago from 57 miles away. Coomes stated that "Chicago is beyond the horizon; you should not be able to see it."⁴⁵ However, it can be seen; it is clearly revealed in Joshua Nowicki's photograph. How does Coomes explain this apparent impossibility? Coomes explained away Nowicki's photograph by averring that the Chicago skyline wasn't really there at all.⁴⁶ He claimed that Nowicki's picture was depicting what is called a "superior mirage." Coomes showed an amazing display of self control, as he kept a straight face throughout his ridiculous explanation.

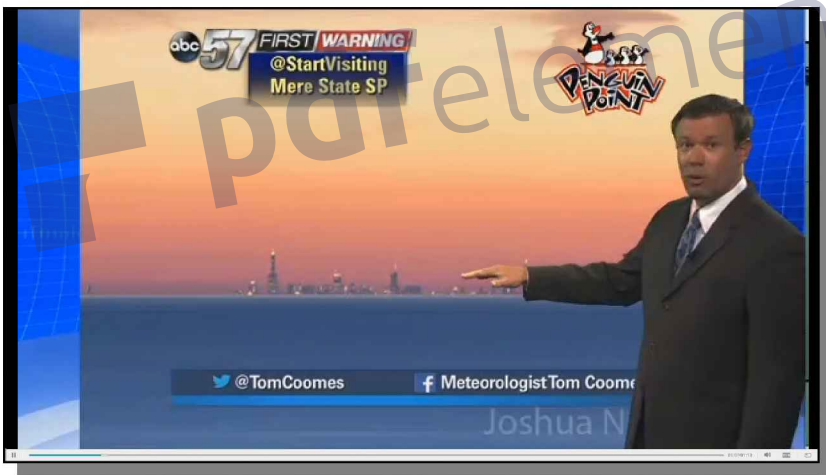

Figure 17: Tom Coomes explaining that Joshua Nowicki's photo of the Chicago skyline was not really there at all; it was a mirage.

The problem with Coomes' explanation is that a superior mirage is a mirage of an object that is usually inverted above the actual object. Sjaak Slanina explains that “[a] superior mirage occurs when an image of an object appears above the actual object.”⁴⁷ The drawing below is from the National Snow and Ice Data Center (NSIDC) and illustrates the inversion of a superior mirage.

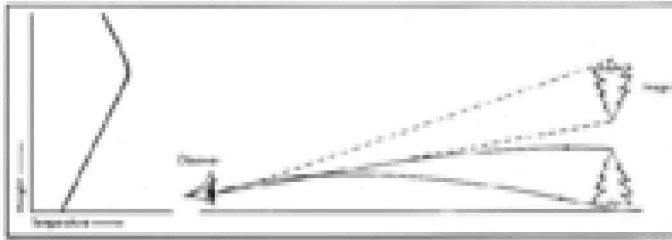

Figure 18: NSIDC Explanatory Diagram of a Superior Mirage

The picture below is an actual superior mirage appearing above a freighter. Notice that the mirage is inverted and appears above the actual freighter. Both the freighter and its mirage are in view. This particular mirage is unusual because of the amount of detail it displays, yet there is still extreme distortion of the mirage; the mirage fades toward the stern of the ship, without the rear cabin being depicted in the mirage at all.

Is it possible to see the Chicago skyline in a superior mirage? The answer is yes. Below is a picture of a superior mirage of Chicago taken from western shore of Michigan, in St. Joseph by J. Michael



Hall on April 18, 2015.⁴⁸ Notice that the Chicago towers are quite indistinct and distorted. Most notably, observe that the towers are upside-down. That is quite different from what is seen in Nowicki's photograph from Grand Mere Park.



Figure 20: Superior mirage of Chicago skyline taken from St. Joseph, Michigan.

The picture by Joshua Nowicki of the Chicago skyline looks nothing like a superior mirage. Nowicki's photograph is detailed and shows the skyline right-side-up. If Nowicki's picture were a superior mirage, the Chicago skyline would most likely be upside-down and extremely distorted.

Below is a picture of the Isle of Man taken from across the Irish Sea at Rossall Beach, England, on August 10, 2012.⁴⁹ The distance between Rossall Beach and Port Soderick, on the east coast of the Isle of Man, is approximately 63 miles.⁵⁰ Rossall beach is at an elevation of 20 feet.⁵¹ Adding 6 feet to that for the height of the photographer, we arrive at a height of the

photographer above the water of 26 feet. Assuming a curved earth, at 26 feet above the water the horizon will not begin to drop below sight from the photographer until a distance of approximately 6 miles. Subtracting 6 miles from the 63 mile distance, between the Isle of Man, we get 57 miles. We must account for the distance of 57 miles of curvature of the earth between the photographer and the shore of the Isle of Man. Using the equation, $\text{miles}^2 \times 8 \text{ inches} = \text{distance below horizon}$, we get 2,166 feet of drop below the horizon of the Isle of Man ($57^2 \times 8 \text{ inches} = 2,166 \text{ feet}$) from Rossall Beach. The Isle of Man has a maximum elevation of 2,037 feet, which means that if the earth were a globe, the top most peak of the Isle of Man would be 129 feet below the horizon.



Figure 21: Isle of Man seen from Rossall Beach, 63 miles away.

Since it is the highest point, and not the shoreline on the Isle of Man, that is at issue, one might wonder what is the distance from Rossall Beach to the highest peak on the Isle of Man. The highest point on the Isle of Man is Snaefell, at 2,307 feet above the Irish Sea. The distance across the Irish sea to Snaefell is also approximately 63 miles.⁵²

The windmills that are seen in the photograph are approximately 9 miles offshore from Rossall Beach. Because the windmills are much closer to the photographer than the Isle of Man they look larger in relation to the Isle of Man than they really are. The windmills have a maximum height of 425 feet above the water to the tip of the rotors turned at 12 o'clock.

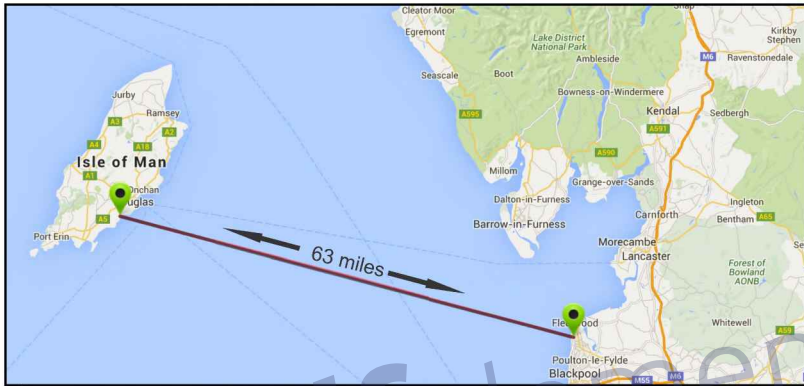
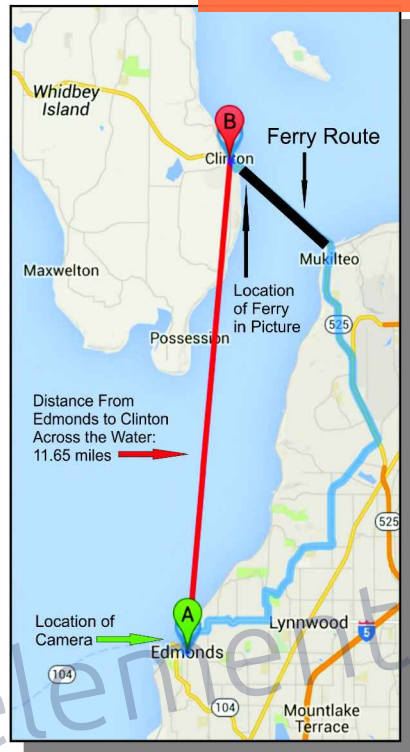

Figure 22: Map showing distance from Rossall Beach to Port Soderick on the east coast of the Isle of Man.

There is no way that the Isle of Man could be seen from Rossall Beach, unless the earth was flat. The above photograph of the Isle of Man from Rossall Beach is stark proof that the earth is in fact flat. The photograph was taken from Rossall Beach and posted on the Rossall Beach Residents and Community Group website to show the beautiful sunset.⁵³ The Rossall Beach Residents and Community had no idea that the photograph shows much more than a beautiful sunset; it is evidence of a flat earth.

The picture below is a frame from a video. A video camera with a telephoto lens was set up approximately 15 feet 11 inches off the water on Fisherman's Pier in Edmonds, Washington.⁵⁴ The camera is looking North-Northeast across Puget Sound toward a ferry that crosses from Mukilteo, Washington to Clinton

Washington. In the picture you will see the ferry about to arrive at Clinton, Washington. The distance from Fisherman's pier to Mukilteo directly across the water is 10.34 miles. As the ferry travels from Mukilteo to Clinton, the distance from the camera gets greater. At the halfway point of travel from Mukilteo to Clinton the distance between the camera at Fisherman's Pier to the lengthens to 10.81 miles. The distance from the Fisherman's Pier to just prior to arrival at Clinton is approximately 11.3 miles. The distance to Clinton, itself, in a straight line from Edmonds as reported on www.FreeMapTools.com is 11.65 miles. For simplicity, as



the ferry in the picture is about to arrive at Clinton, we will round down the distance to 11 miles. If the earth were round, as is commonly believed, the entire ferry should not be able to be seen from Fisherman's Pier. At a distance of 11 miles, and adjusting for the height of the camera off the dock, (for simplicity, we will round up to 16 feet), a globular earth would put the ferry below the horizon by approximately 25 feet. That is, the bottom 25 feet of the ferry should not be visible at all. In the picture, however, the black topsides of the hull can be seen against the white deck cabins. The first deck cabin is a car-deck, with a clearance of 16 feet. It is visible in the picture, but it should be below the horizon if the earth were a globe. However, we can see the entire ferry, including the black topside of the hull on the waterline, from the bow to the stern. Very simply, the only way the entire ferry could

be seen in the picture below is if the earth is flat.

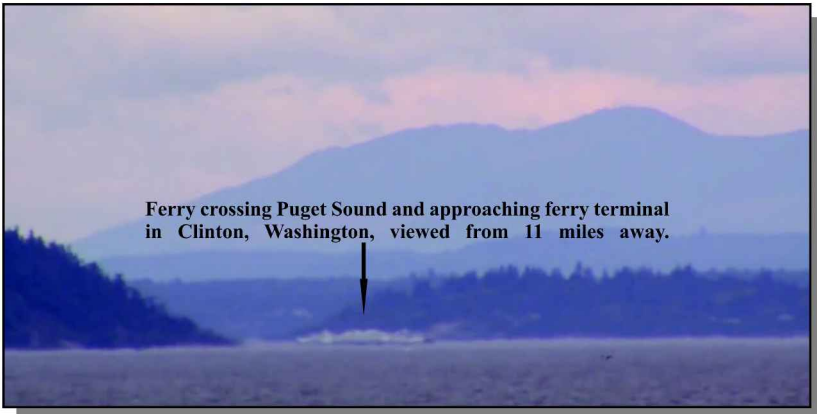

Figure 24: Frame from video of ferry taken from 11 miles away.

Below is a diagram of the actual ferry depicted in the above picture, the Toitea.⁵⁵ Approximately 25 feet should have been blocked by the horizon if the earth were a globe. You can see that 25 feet would cover the entire black topside of the hull and the first deck, which are visible in the photograph above. The manufacturer of the ship states that the black topside is 8 feet off the water.⁵⁶ The green stripe is approximately 3 feet wide. The black topsides and the green stripe, which amount to 11 feet total, should be completely below the curvature of the earth, if the earth were a globe. However, you can see clearly the black topside of the ferry against the waterline.



Below is a photograph taken from the Promenade of Nevi.⁵⁷ The picture was taken on December 4, 2007.⁵⁸ The picture shows the Island of Corsica in the distance. The tallest mountain on Corsica is Monte Cinto, which rises 8,878 feet above sea level. Monte Cinto is 139 miles from Nevi. Nevi has a maximum elevation of 82 feet above sea level. Taking into account the elevation of the photographer at Nevi (82 feet above sea level + 6 feet in height = 88 feet), we subtract 12 miles from the 139 mile distance. If the earth were a globe, there would be 127 miles of curvature between the photographer at Nevi and the highest point on Corsica, Monte Cinto. That supposed curvature would create a drop of 10,753 feet in the 127 mile distance. That means that if the earth were a globe, the top of Monte Cinto should be completely out of view 1,875 feet below the horizon ($10,753 - 8,878 = 1,875$). That, however, is not the case. The Island of Corsica, all the way to the top of Monte Cinto, is in view in the photograph, which means that the earth is not a globe. The photograph of Corsica, taken from Nevi, could only happen on a flat earth.



Figure 26: Picture of the Island of Corsica, taken from Nevi, 139 miles away from the tallest peak on Corsica, Monte Cinto. If the earth were a globe, the peak on Monte Cinto should be 1,875 feet below the horizon.

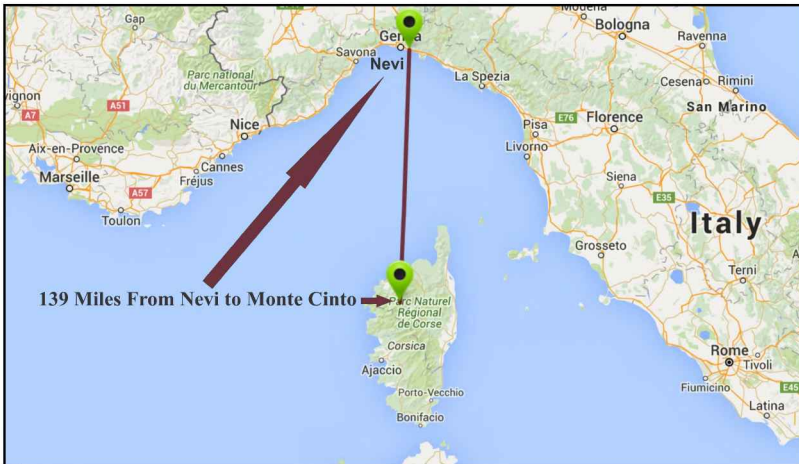

The United States Coast Guard has provided a chart of navigational lights and buoys.⁵⁹ The chart proves that the earth is flat. For example, the U.S. Coast Guard lists the focal plane of the Cape Canaveral Lighthouse as being 137 feet above the mean high water level. The nominal range of the light is listed as 24 nautical miles (approximately 28 statute miles).⁶⁰ The nominal range is the “maximum” distance at which a light can be seen in clear weather, which is defined as conditions that allow for the visibility of 10 nautical miles.

Assuming the earth is a globe and the sailor observing the Cape Canaveral Lighthouse is 10 feet above the level of the sea when observing the Cape Canaveral Lighthouse, the curvature of the earth would put the light on the lighthouse 247 feet below the horizon at the distance of 28 statute miles from the observer. To account for the height of the observer above the level of the sea (10 feet), we take the 28 statute miles and subtract 4 statute miles (which gives us 24 miles). We then take the square of the 24 miles (576) and multiply that number by 8 inches and we get 4,608 inches (384 feet) drop below the horizon on a supposed curved globe. We then subtract the height of the focal plane of the lighthouse (137 feet) from the horizon drop (384 feet) and we find the light on the Cape Canaveral Lighthouse would be 247 feet below the horizon assuming that the observer was 10 feet above the sea level at a distance of 28 miles from lighthouse. However, the lighthouse is not 247 feet below the horizon. That can mean only one thing: the earth is not a globe. The ability of mariners to see the Cape Canaveral Lighthouse from a distance of 28 statute miles is proof that the earth is in fact flat.

The above cited publication from the United States Coast Guard posts a Geographic Range Table that gives “the approximate geographic range of visibility for an object which may be seen by an observer at sea level.”⁶¹ The table can be seen below. The objects at the given height could not be seen at the

distances listed in the table if the earth were a globe. For example the table establishes that an object that is 200 feet above sea level can be seen by an observer at sea level from a distance of 16.5 nautical miles (19 statute miles). If the earth were a globe, the top of that 200 foot object would be 40 feet below the horizon from 19 statute miles away ($19^2 \times 8$ inches = 240 feet). The range table is accurate, as it is based upon real world testing and experience. The objects listed in the range table could only be seen from the distances on the chart if the earth is flat. The range table presents official evidence from the United States Coast Guard proving that the earth is flat.

GEOGRAPHIC RANGE TABLE					
The following table gives the approximate geographic range of visibility for an object which may be seen by an observer at sea level. It is necessary to add to the distance for the height of any object the distance corresponding to the height of the observer's eye above sea level.					
Height Feet / Meters	Distance Nautical Miles (NM)	Height Feet / Meters	Distance Nautical Miles (NM)	Height Feet / Meters	Distance Nautical Miles (NM)
5/1.5	2.6	70/21.3	9.8	250/76.2	18.5
10/3.1	3.7	75/22.9	10.1	300/91.4	20.3
15/4.6	4.5	80/24.4	10.5	350/106.7	21.9
20/6.1	5.2	85/25.9	10.8	400/121.9	23.4
25/7.6	5.9	90/27.4	11.1	450/137.2	24.8
30/9.1	6.4	95/29.0	11.4	500/152.4	26.2
35/10.7	6.9	100/30.5	11.7	550/167.6	27.4
40/12.2	7.4	110/33.5	12.3	600/182.9	28.7
45/13.7	7.8	120/36.6	12.8	650/198.1	29.8
50/15.2	8.3	130/39.6	13.3	700/213.4	31.0
55/16.8	8.7	140/42.7	13.8	800/243.8	33.1
60/18.3	9.1	150/45.7	14.3	900/274.3	35.1
65/19.8	9.4	200/61.0	16.5	1000/304.8	37.0

Example: Determine the geographic visibility of an object, with a height above water of 65 feet, for an observer with a height of eye of 35 feet.	Enter above table; Height of object 65 feet= 9.4 NM Height of observer 35 feet= 6.9 NM Computed geographic visibility= 16.3 NM
---	---

Figure 28: United States Coast Guard Geographic Range Table

3 **Water Not Convex Proves Earth Is Not a Globe**

Water always seeks its own level, because water is always level. Water cannot be anything but perfectly flat. There is never any convexity to water, as would be required by a globular earth. All oceans, seas, and lakes are perfectly level. Indeed, we use the term “water level” to denote the status of the flat and level water. The very terms we use are based upon water always being flat and level across its length and breadth.



Figure 29: Water is always perfectly level, and thus the horizon on water is always perfectly flat, with no curvature.

No matter what configuration you pour water into, it is always level. It is an irrefutable physical reality that can be replicated by anyone. The image below illustrates that reality.⁶²

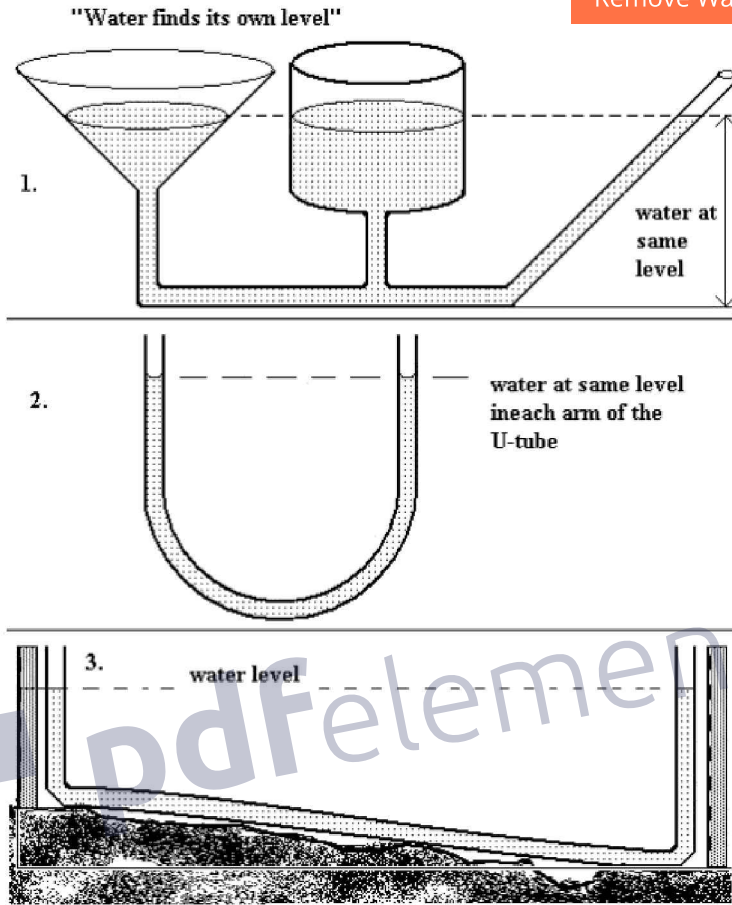

Eric Dubay, in his book, *The Flat Earth Conspiracy*, quotes an engineer, whose job it was to construct canals and railways. The engineer explained that no allowance is made for the supposed curvature of the earth. Why not? Because the earth is flat.

Engineer, W. Winckler, wrote into the *Earth Review* October 1893 regarding the Earth's supposed curvature, stating, "As an engineer of

many years standing, I saw that this absurd allowance is only permitted in school books. No engineer would dream of allowing anything of the kind. I have projected many miles of railways and many more of canals and the allowance has not even been thought of, much less allowed for. This allowance for curvature means this – that it is 8” for the first mile of a canal, and increasing at the ratio by the square of the distance in miles; thus a small navigable canal for boats, say 30 miles long, will have, by the above rule an allowance for curvature of 600 feet. Think of that and then please credit engineers as not being quite such fools. Nothing of the sort is allowed. We no more think of allowing 600 feet for a line of 30 miles of railway or canal, than of wasting our time trying to square the circle.”⁶³

The Suez Canal is just one example that stands as irrefutable proof that the earth is flat. The canal runs for 100 miles. There are no locks in the canal; it is perfectly level for the entire 100 miles. If the earth were a globe, each end of the canal would necessarily be over one mile below the horizon from the other end. That would mean that the middle of the canal would be elevated in a round hump 1,666 feet in the mid-point of the canal. However, that is not the case. David Wardlow Scott, in his book, *Terra Firma*, explained:

The distance between the Red Sea at Suez and the Mediterranean Sea is 100 statute miles, the datum line of the Canal being 26 feet below the level of the Mediterranean, and is continued horizontally the whole way from sea to sea, there not being a single lock on the Canal, the surface of the water being parallel with the datum line. It is thus clear that there is no curvature or globularity for the

whole hundred miles between the Mediterranean and the Red Sea; had there been, according to the Astronomic theory, the middle of the Canal would have been 1,666 feet higher than at either end, whereas the Canal is perfectly horizontal for the whole distance.⁶⁴

The Suez Canal offers such stark proof that the earth is flat that a more detailed study of that canal is warranted. Samuel Rowbotham provides us that explanation, complete with actual illustrations from the authorities. The official illustrations reveal a flat earth.

The completion of the great ship canal, which connects the Mediterranean Sea with the Gulf of Suez, on the Red Sea, furnishes another instance of entire discrepancy between the theory of the earth's rotundity and the results of practical engineering. The canal is 100 English statute miles in length, and is entirely without locks; so that the water within it is really a continuation of the Mediterranean Sea to the Red Sea. "The average level of the Mediterranean is 6 inches above the Red Sea; but the flood tides in the Red Sea rise 4 feet above the highest, and its ebbs fall nearly 3 feet below the lowest in the Mediterranean." The datum line is 26 feet below the level of the Mediterranean, and is continued horizontally from one sea to the other; and throughout the whole length of the work, the surface of the water runs parallel with this datum, as shown in the following section, fig. 38, published by the authorities.⁶⁵



fig. 38

A, A, A, is the surface of the canal, passing through several lakes, from one sea to the other; D, D, the bed of the canal, or horizontal datum line to which the various elevations of land, &c., are referred, but parallel to which stands the surface of the water throughout the entire length of the canal; thus proving that the half-tide level of the Red Sea, the 100 miles of water in the canal, and the surface of the Mediterranean Sea, are a continuation of one and the same horizontal line.⁶⁶

The actual survey of the Suez Canal proves that the surface of the water is flat for 100 miles from one end of the canal to the other. That flat span of water could only be possible if the earth is in fact flat. Rowbotham modifies the official illustration of the Suez Canal to show a fictional depiction of how the Suez Canal would appear if the earth were a globe. The unreal depiction (which would be required if the earth were a globe) is not at all what is seen and measured at the Suez Canal. The convex bow of water (which is a physical impossibility) illustrates the impossibility that the earth is a globe.

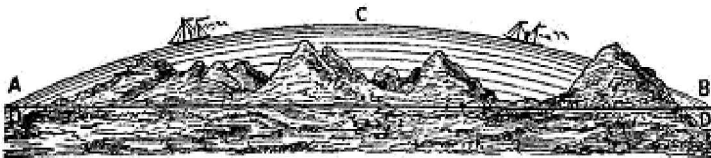

fig. 39

If the earth is globular, the water in the centre of the canal, being 50 miles from each end, would be the summit of an arc of a circle, and would stand at more than 1600 feet above the Mediterranean and Red Seas ($50^2 \times 8$ inches = 1666 feet 8 inches), as shown in diagram, fig. 39.⁶⁷ A, the Mediterranean Sea; B, the Red Sea; and A, C, B, the arc of water connecting them; D, D, the horizontal datum, which, if the earth is globular, would really be the chord of the arc, A, C, B.⁶⁸

Rowbotham continues with his proof of the flat earth by explaining the survey of a body of water that is exponentially larger than the Suez Canal. Rowbotham reveals the actual survey measurements of the floor of the Atlantic Ocean from Valencia, Ireland, to Newfoundland, Canada, prior to laying the transatlantic cable. That survey proves beyond any doubt that the earth is flat. Rowbotham describes the depth of the Atlantic Ocean in fathoms; one fathom equals six feet, which is two yards. Please note that Rowbotham discusses the distance across the Atlantic Ocean in nautical miles, whereas his discussion of the span of the Suez Canal is in statute miles. A nautical mile is equal to approximately 1.15 statute miles. In the equation for the supposed drop below the horizon expected if the earth were a globe ($M^2 \times 8$ inches = Drop), the miles (M) are always in statute miles.

The bed of the Atlantic Ocean, from Valencia (western coast of Ireland) to Trinity Bay, Newfoundland, as surveyed for the laying of the cable, is another illustration or proof that the surface of the great waters of the earth is horizontal, and not convex, as will be seen by the following diagram [fig. 40], contracted from the section, published October 8, 1869, by the Admiralty. C, D, is the horizontal datum line, and A, B, the surface of the water, for a distance of

1665 nautical, or 1942 statute miles. At about one-third the distance from A, Newfoundland, the greatest depth is found--2424 fathoms; the next deepest part is 2400 fathoms; at about two-thirds the distance from A, towards B, Ireland, while in the centre, the depth is less than 1600 fathoms.⁶⁹

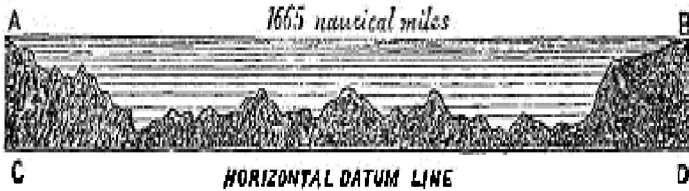

fig. 40

The actual depiction of the Atlantic Ocean is a large flat body of water spanning 1,665 nautical miles from Newfoundland to Ireland. Such would be the case only if the earth is in fact flat. Rowbotham, again, modifies the official illustration to create a fictional depiction of the span across the Atlantic Ocean as it would necessarily appear if the earth were a globe (fig. 41). The unreal depiction is not at all what is found when surveying the Atlantic Ocean.

[W]hereas, if the water of the Atlantic is convex, the centre would stand 628,560 feet, or nearly 120 miles, higher than the two stations, Trinity Bay and Valencia; and the greatest depth would be in the centre of the Atlantic Ocean, where it would be 106,310 fathoms, instead of 1550 fathoms, which it is proved to be by actual soundings. Fig. 41 shows the arc of water which would exist, in relation to the horizontal datum line, between Ireland and Newfoundland, if the earth is a globe. Again, if the water in the Atlantic Ocean is convex--a part of a great sphere of 25,000 miles

circumference--the horizontal datum line would be a chord to the great arc of water above it; and the distance across the bed of the Atlantic would therefore be considerably less than the distance over the surface. The length of the cable which was laid in 1866, notwithstanding the known irregularities of the bed of the Ocean, would be less than the distance sailed by the paying-out vessel, the "Great Eastern;" whereas, according to the published report, the distance run by the steamer was 1665 miles, while the length of cable payed out was 1852 miles.⁷⁰

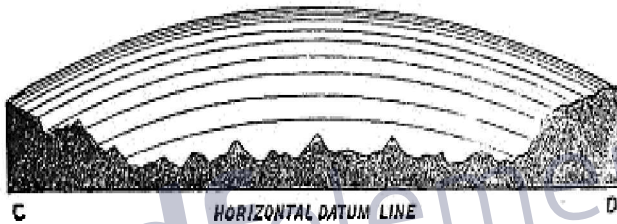

fig. 41

Rowbotham puts the final nail in the coffin of the globular earth fiction by pointing out that the distance that the steamer traveled across the Atlantic Ocean as it laid the cable was approximately 1,665 miles, which is exactly what would be expected if the vessel was traveling in a straight line across the Atlantic Ocean on a flat body of water.

4 The Earth Is Flatter Than a Pancake

Of course, land, with its mountains and valleys, is not perfectly level, as is water. However, when large expansive areas of land are considered, it can be determined that land is not convex, as would be expected on a spherical earth. Land is generally flat. Scientific research proves that fact. For example, Mark Fonstad, Ph.D., William Pugatch, and Brandon Vogt, Ph.D., used data from the United States Geological Survey to determine that, on scale, the State of Kansas is literally flatter than a pancake.⁷¹ On a scale where one (1) is perfectly flat, the geographers used a confocal laser to determine that a pancake had a measured flatness of .957. The State of Kansas was scaled down using a 1:250,000 scale digital elevation model (DEM). Kansas was found to have a measured flatness of .9997.

Fonstad, et al., compared transections of a pancake and the east-west profile of merged relief data from the State of Kansas. The pancake used by Fonstad, et al., was obtained from an IHOP restaurant. Its relief was measured at 2 millimeters over a diameter of 130 millimeters.⁷² Relief means the quantitative measurement of vertical elevation change in a landscape over a given area. For an area of land, the relief can be obtained by subtracting its highest point in elevation from its lowest point. A simple way to compare the relief of two transected profiles of different sizes is to divide

the relief by the length of the transection. The resulting relief quotient can be used to compare the relief of the two transected profiles. The lower the relief quotient, the flatter is the area. The relief quotient for the pancake in the Fonstad, et al., research project was .015 ($2 \div 130 = .015$).

The highest point in the State of Kansas is 4,039 feet above sea level, and the lowest point is 679 feet above sea level. The relief for Kansas, therefore, is 3,360 feet (.64 miles). The east-west transection of Kansas is 400 miles across, resulting in an approximate relief quotient of .0016 ($.64 \div 400 = .0016$). The comparison of relief quotients confirms the results obtained by Fonstad, et al. Kansas is, by far, flatter than a pancake.

Jerome Dobson, President of the American Geographical Society and Professor of Geography at the University of Kansas and Joshua Campbell, geographer and GIS architect in the Office of the Geographer and Global Issues at the U.S. Department of State, came to the defense of the State of Kansas. They did not want people to think that Kansas was flat and boring. Dobson and Campbell concluded that according to the research study of Dr. Fonstad, et al., in order for Kansas not to be flatter than a pancake over its 400 mile span, would require Kansas to have a mountain that is 32,506 feet (approx. 6 miles) above sea level ($400 \text{ miles} \times .015 \text{ relief quotient for a pancake} = 6 \text{ miles}$).⁷³ Such a six (6) mile high mountain would be approximately 10 times the actual variation in terrain in Kansas, and taller than the tallest mountain in the world, which is Mount Everest, at 29,029 feet above sea level.⁷⁴

If the earth were a globe, Kansas would have a bulging arc more than 26,666 feet (5 miles) above sea level. Interestingly, that would give Kansas a relief quotient of .0125, which would still make Kansas flatter than a pancake, which has a relief quotient of .015. Does that mean that the earth is a globe? No, it does not. Because, the maximum actual relief in Kansas is only 3,360 feet,

giving it an actual relief quotient of .0016, which means that there is no such five mile bulging arc, as would be required on a globe.

Furthermore, the larger the land mass the greater is the arc that would be expected in the hypothesized spherical earth. For example, Florida, which was determined by Dobson and Campbell to be flatter than Kansas, could only be flatter than Kansas if the earth was flat. Florida is 447 miles across from north to south. If the earth were a sphere, that would give Florida a bulging arc of 33,153 feet (6.27 miles) and a relief quotient of .014. That means that if the earth were a globe, Kansas, with a relief quotient of .0125 on a supposed globular earth, should be flatter than Florida. But in actuality Florida is flatter than Kansas. Indeed, Florida is the flattest state in the United States. The fact that Florida was determined by actual measurements to in fact be flatter than Kansas, means that the earth cannot be a globe; it must be flat.

In general, the larger the area measured on earth, the flatter is the actual relief quotient, which is the very opposite of what would be expected on a spherical earth. Indeed, when the relief quotient calculations are applied across a large expanse of land, for thousands of miles, the difference in relief quotients between the figures for a globular hypothesis and the actual relief quotients are stark.

For example, the continental United States is approximately 2,800 miles across. If the earth were a globe, the continental United States would have a terrain with a bulged arc approximately 1,306,666 feet (247 miles) above sea level across it. No such topographical bulge exists. If the earth were a globe the continental United States should have a relief quotient of .088 ($247 \div 2,800 = .088$). The actual relief quotient of the continental United States, however, does not come close to the relief quotient (.088) that would be expected on a spherical earth.

The highest point in the continental United States is 14,494

feet above sea level, and the lowest point is 282 feet below sea level. The relief across the 2,800 mile breadth of the continental United States is therefore 14,776 feet (2.8 miles) ($14,494 + 282 = 14,776$) (14,776 feet = 2.8 miles). The reason that 282 feet is added to the 14,494 feet is because the 282 foot elevation is below sea level. Dividing 2.8 miles by the 2,800 mile breadth of the continental United States gives us a relief quotient of .001 ($2.8 \div 2,800 = .001$).

The actual relief quotient for the continental United States of .001 means that the earth cannot be a sphere. If the earth were a sphere the relief quotient for the continental United States would be exponentially greater (.088).

Using a pancake as a gauge of flatness, we find that the terrain of the continental United States is, on scale, significantly flatter than a pancake. It is not even close. The relief quotient of a pancake is approximately .015, which is exponentially greater than the .001 relief quotient of the continental United States. That means that the continental United States is flat, which in turn means that the earth is flat.

Simple calculations, as were done above with the continental United States, prove that the earth is not a sphere but is, in fact, flat. The study by Dr. Fonstad, et al., has far reaching implications, not lost on geographers. Lee Allison, the Director of the Kansas Geological Survey, concluded from that research study that “everything on Earth is flatter than the pancake as they measured it.”⁷⁵

Dr. Dobson, performed additional research on the issue of the flatness of Kansas.⁷⁶ Dr. Dobson was joined in his research by Joshua Campbell. Dobson and Campbell used a different methodology than did Dr. Fonstad, et al., but their research confirmed the results of Dr. Fonstad, et al.

Most notably, Dobson and Campbell found that the entire United States was flatter than a pancake. Dobson and Campbell further discovered that Florida, Illinois, North Dakota, Louisiana, Minnesota and Delaware were all flatter than Kansas.⁷⁷

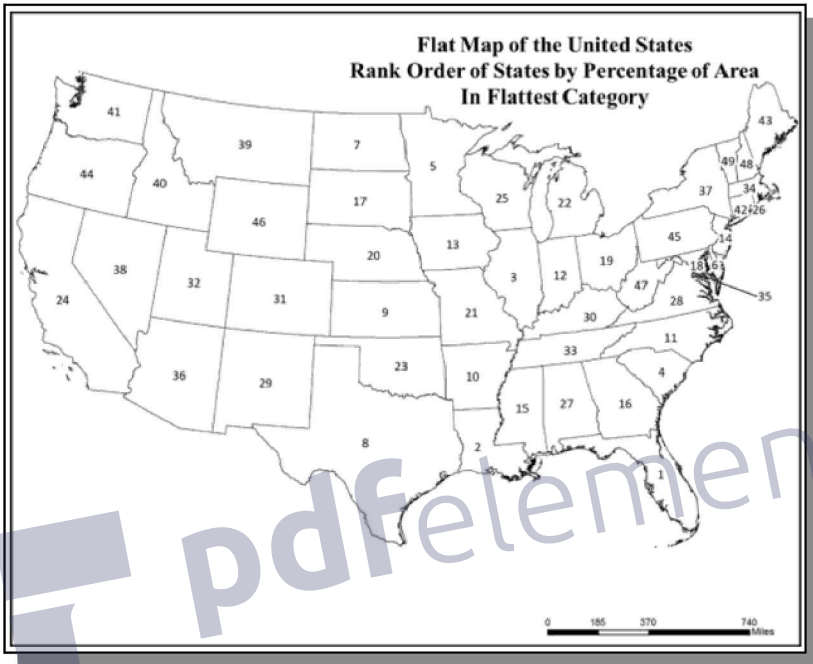

Figure 35: Flatness ranking map for states prepared by Jerome Dobson and Joshua Campbell as published in *The Atlantic*.

Dr. Dobson extrapolated from his own confirmatory research that the entire world is flatter than a pancake. Dr. Dobson had this to say about the research study by Dr. Fonstad, et al.: “Our own findings did not refute their conclusion about Kansas but rather proved that their conclusion applies to the whole world.”⁷⁸ Dr. Dobson’s research was published in the *Geographical Review*, a peer-reviewed journal published by the American Geographical Society. Neither Dobson and Campbell’s findings, nor those of Dr. Fonstad, et al., have ever been refuted or even challenged. For the United States, on scale, to be flatter than

a pancake, necessarily means that the earth must be flat. The research of Dobson, Campbell, and Fontad, et. al., proves that to be the case.

 pdfelement

5 Mountains of Proof

Jon McIntyre was troubled by the evidence of the flat earth and simply could not bring himself to accept that such a massive conspiracy to hide the very nature of the earth could exist. He came up with an ingenious way to determine, once and for all, whether the earth was a sphere or flat. He concluded that if the earth were flat then two equally high mountains separated by many miles would appear to the observer to be the same height if the observer was stationed at a vantage point that was equal in height to the peak of the two mountain tops.

All he needed to do was to move perpendicular to the alignment of the mountains, thus creating a parallax between the mountains, and he could then see both mountains side-by-side. If, however, the earth were a globe, then the more distant mountain top would drop below the height of the nearer mountain top by the distance in miles squared multiplied by eight inches ($\text{miles}^2 \times 8 \text{ inches} = \text{distance of drop on the supposed spherical earth}$).

McIntyre searched and found three mountains that met his criteria.⁷⁹ The three mountains were found in the Black Mountain Range in North Carolina. He positioned himself with his camera at an elevation of 5,385 feet on the ridge of Tennent Mountain. He

then trained his camera at Fryngpan Mountain, six (6) miles in the distance from his position on the ridge at Tennent Mountain. The peak of Fryngpan Mountain has an elevation of approximately 5,380 feet above sea level. Thirty four (34) miles beyond Fryngpan Mountain was Graybeard Mountain, with an elevation of approximately 5,395 feet.



Graybeard Mountain, which is 34 miles behind Fryngpan Mountain, would have dropped with the curvature of the earth 770 feet below the horizon and out of sight behind Fryngpan Mountain if the earth were a globe.

McIntyre's position was to the side of Fryingspan Mountain, which created a parallax between it and Graybeard Mountain. This allowed him to view both the mountains juxtaposed to one another, although they were separated by 34 miles. He discovered that in fact the mountain tops were almost the same height, just as indicated by their official reported elevations.

If the earth were a globe, then the curvature of the earth would cause Graybeard Mountain to drop 770 feet and be out of the sight of the observer. But that is not what we see.

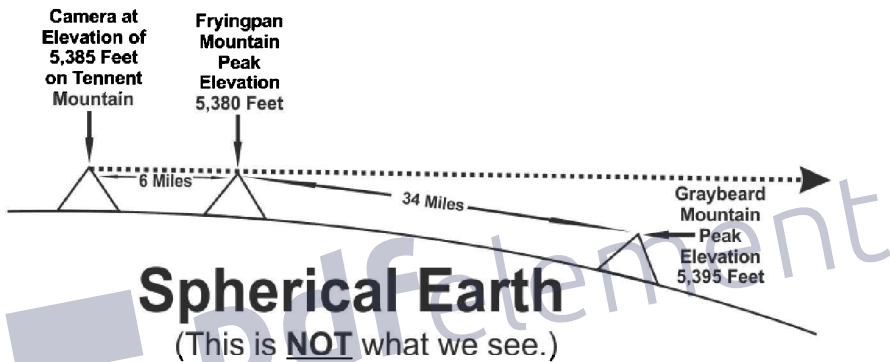

The picture taken by McIntyre clearly shows Graybeard Mountain and Fryingspan Mountain at their reported heights juxtaposed to one another.

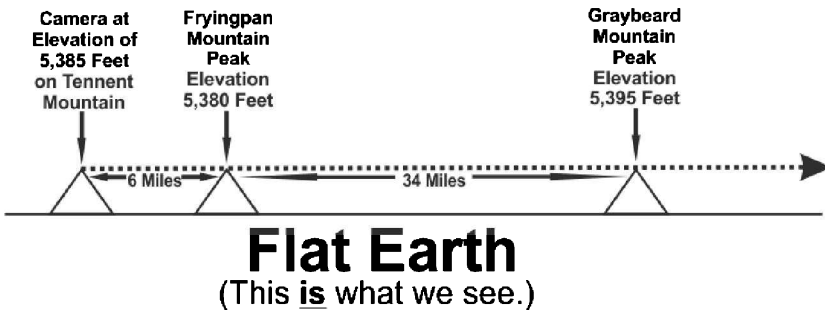

Such a configuration as depicted in McIntyre's photograph would be impossible on a spherical earth. His picture is compelling evidence that the earth is flat.

It should be noted that McIntyre is not a believer in the flat earth. The most he can bring himself to say on the issue of whether the earth is flat is: "I don't know." But he cannot otherwise explain the phenomenon of the mountain peaks being the same height in relation to one another as officially reported, although they are separated by 34 miles. He states that he can "find no way to interpret this data other than to say that it clearly supports the conclusion that the earth is flat." Yet, he cannot bring himself to believe it. The implications for him are just too disturbing.

This shot I find to be completely bizarre. Do I believe that the earth flat? That's a big leap to make. A really big leap to actually believe in a conspiracy theory of that size. It is craziness! But what am I supposed to do with this evidence? I don't really know. Honestly, I don't really know. But I felt compelled to make this video. I felt compelled to collect irrefutable evidence one way or the other, so I could end the internal debate I was having about it and answer the questions I was having regarding flat earth, because I did find the debate interesting.⁸⁰

It seems that McIntyre finds the evidence in his experiment that proves that the earth is flat to be compelling. He put a lot of work and study into conducting his experiment, but when the results pointed clearly and irrefutably toward a flat earth, McIntyre could not fully believe that the earth is flat. To do so would be to make "a really big leap to actually believe in a conspiracy theory of that size." He has been thoroughly conditioned to ignore his senses and view the results of his test as "craziness" no matter how convincing is the evidence. McIntyre admits that, although the

evidence in his experiment is compelling proof that the earth is flat, he cannot bring himself to accept it, because he cannot overcome his conditioning from “a lifetime of being told that I live on a globe flying through space.”

My love of truth and love of the pursuit of truth compelled me to conduct this experiment and produce this video. I find the evidence I collected to be very convincing. In fact I find no way to interpret this data other than to say that it clearly supports the conclusion that the earth is flat. Yet if you were to ask me if I believe the earth is flat my answer would be “I don't know” because at this point I truly do not know what I believe. I am fully aware of what this evidence is pointing to and yet my mind seems unable to firmly settle on the belief that the earth is flat. Maybe this is due to a lifetime of being told that I live on a globe flying through space.⁸¹

McIntyre's research video has been attacked by deceptive debunkers. Indeed, the purported debunking website, Metabunk.com, was so full of errors and misrepresentations that McIntyre called the deceptive posters: “liars.” The whole purpose of the heliocentric posters is to deceive the unwary and ignorant who the posting charlatans know will not truly dig into the details. It is an age-old strategy of befuddling people with misleading details so they will just throw up their hands in frustration and reject the otherwise convincing evidence that would upset the mythology of the status quo.

Below is a quote from McIntyre about the supposed debunking of his video on the forum at Metabunk.com. Keep in mind when reading McIntyre's reaction to the deceptive posts that he, to this day, does not accept that the earth is flat. That means he agrees with the viewpoint of the debunkers that the earth is a

sphere, but he nonetheless calls them liars. He calls them liars, because he knows his facts and understands how they are twisting the evidence to mislead others. McIntyre will not tolerate misrepresentations of the evidence. McIntyre strives to find and accurately report the truth and will not allow his work to be maligned by liars who have an agenda to deceive people into believing that the earth is a sphere; even though he, himself, believes the earth is a sphere. Indeed, he pulls no punches and describes the so-called debunkers as “liars.”⁸² McIntyre states:

Look, this is exactly what I'm not going to deal with. I spent many, many days hiking around those mountains trying to locate the perfect position to get the shot. The whole entire time I was intermittently seeing Fryingpan and Graybeard. And I've been up there probably more than twenty times since and I still see them all of the time. I hike over Tennent regularly. Guess what? I see Fryingpan and Graybeard and they look exactly the same as in my shot because guess what??? They are the same mountains. How in the world do I go up there and spend all of this time up there and hike all of these mountains. I've been to the top of all of these peaks. I know these peaks. I see them all the time. And then somehow when I need to find a shot on my line of sight and at the right elevation I suddenly forget what they look like.

I quite seriously do not appreciate this. Not you bringing this to my attention but a liar lying and the trying to force me in some way to pay attention to these lies as though they are worthy of attention. The assertions by that page you sent me are.... I don't know... absurd, outright lies, inanity. I verified those peaks. I live near those peaks. I hike those peaks. I was directly on that line which is

obvious to anyone who can think because it looks exactly like the image on Peakfinder.

Furthermore, just take a look at the mountain range in the distance that includes Graybeard. LOOK AT IT. To the left of Bald Knob you see a steady incline all the way up to the hogback of Mount Mitchell. It's obvious. Look at it. then look at Peakfinder and examine the way it looks. That ridge of mountains is unique and completely identifiable to anyone willing to think.

I hike up there all the time. I drive up the Blue Ridge Parkway all of the time. And I've hiked down the ridge to Graybeard from the road. When I'm driving up the Blue Ridge I have Mt. Mitchell on my left and I'm looking to the right and guess what I see... to the furthest left: Graybeard, slightly closer: Pinnacle, then even closer: Bald Knob. I've sat on top of those peaks. I know them. I've hiked that trail and been up there. I've used my topo maps for navigation. I've seen them from multiple angles and multiple mountain tops.

... I hate liars. I've seen those peaks from many angles and made sure to be thorough and yet I have some guy making up lies about me and my test. Look, you are free to read that trash and believe it. You are being lied to. [If] you bring it to my video again, sincere or not, I [will] delete [your] comments and I [will] block you.

Why? Very simple. I will not allow lies and deception to be promoted along with my video on my channel. I won't have it. I'm done. Bring legitimate, honest debunking to my comments or

don't bring anything. Stop being lazy.

Go to Peakfinder. Take a look at how that mountain range looks and then watch my video. It is obviously the same mountain range. I should not have to spend my time explaining something to you that is so completely obvious. Instead of checking with me to see if some debunker has made a point just go spend an hour and look for yourself. It is easy. And you will see they are lying.⁸³

 pdfelement

6 The Testimony of Buildings and Bridges

Parallel lines are two lines that are always the same distance apart and never touch. The fact that walls on buildings and columns on bridges are parallel, testify to the fact that the earth is flat. Indeed, no wall on any building on a spherical earth could be parallel if they are constructed using plumb bobs or spirit levels. Rob Alphanostrum illustrates in the diagram below how it can be verified that the earth is in fact flat by using weighted plumb bobs.⁸⁴

If two plumb bobs are hung from a bridge, or any high platform, the lines attached to the plumb bobs will be the same distance apart at the top as at the bottom. The lines will always be parallel no matter how far apart they are hung. That parallel phenomenon could only happen on a flat earth. If the earth were a sphere, the spherical earth theory requires that the distance between the plumb bobs at the top would be greater than at the bottom. That is because on a spherical earth, the theory of gravity requires that a plumb bob, wherever it is on earth, must be pulled to the center of the earth. The vectors of the force of gravity would be like the spokes on a wheel splaying outward from the center of the wheel. The plumb bobs would follow the force vectors of gravity, if the earth were a globe. But that is not what we see. What we see is that the lines holding the two adjacent plumb bobs

will always be parallel no matter how far apart they hang. That could only mean that the earth is flat.

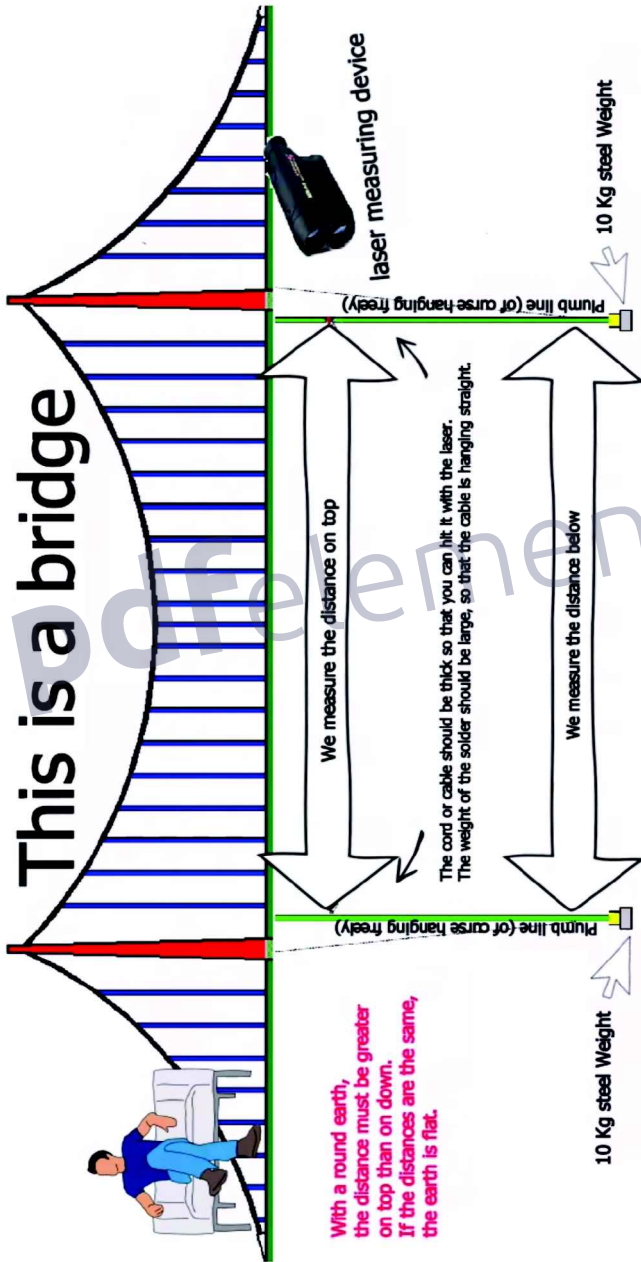

Malcolm Bowden is a retired civil and structural engineer, and a well respected geocentrist. While Bowden is an ardent believer that the earth is the center of the universe, he also believes that the earth is a sphere, and he is very much against any notion of a flat earth. He has created a video titled, *Flat Earth Stupidity Exposed*.⁸⁵ In his video he presented an explanation of the construction of a bridge which showed the columns of the bridge, where each column is required **not** to be parallel, because he believes the earth is spherical. He claims that is how bridges are built on the supposed spherical earth. In his video, he showed how a spirit level is used on theodolites to construct bridges. The two bridge depictions below are from Bowden's video. His annotations as they appeared in the video are the small black typeface. My annotations are the larger gray typeface framed by brackets. The top depiction is a bridge on a flat earth that Bowden falsely claims is wrong. The bottom depiction is a bridge on a spherical earth that Bowden falsely claims is correct.

[Bowden falsely claims that this is wrong.]

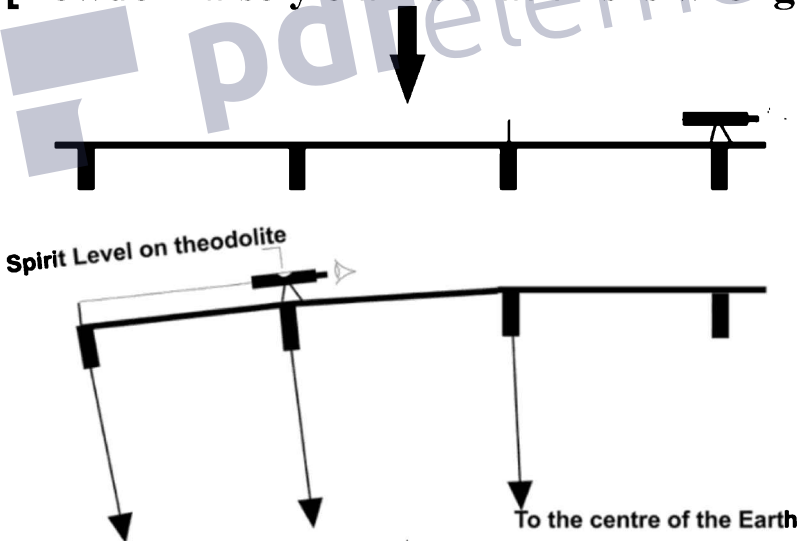

[Bowden falsely claims that this is correct.]



Bowden claims that the spirit level creates bridge columns that point toward the center of a spherical earth. He is correct that theodolites with spirit levels are used to build bridges, but they do not create columns that point to the center of a spherical earth, because the earth is not a sphere. The spirit level ensures that the theodolite is precisely level to the earth, thus ensuring that the bridge columns are vertically plumb. The resulting columns in the real world would be perpendicular to the level water and perfectly parallel to each other, just as depicted in the top bridge depiction. Bowden's bowed bridge in the lower depiction is a myth, created entirely in his mind. The fact that bridge columns in the real world are in fact parallel proves that the earth is flat.

Bowden's video is provably false. I posted a comment under the video explaining how his argument regarding bridge construction in fact proved the very opposite of his claim. His argument proved that the earth is flat. Below is my posted comment:

Edward Hendrie: The entire video is chock full of erroneous information, but for brevity, I will focus on Bowden's single bridge explanation, because in his explanation he has in fact proven that the spherical earth is impossible.

On one point, he is correct, that all construction of buildings and bridges use a level. As he indicated, all vertical support columns on a bridge are plumbed straight. That single truth in his bridge explanation actually proves the earth is flat. That is because if the earth were a globe as he suggests, and bridges are thus curved on a flat earth, as he claims, the columns on the bridges would splay out from one another. Indeed, his video illustrates that point. None of the columns on his mythical bridge are parallel. However, all

support columns on real bridges in the real world are parallel, which can only mean that the earth is flat.

Buildings are built upon the same principle as bridges, with the walls plumbed level to the surface of the earth. If the earth were a sphere, as Bowden claims, the walls would splayed outward from one another on all buildings. On a sphere, no walls in any building could ever be parallel. Every floor on a high rise building would be progressively larger as you got higher and higher. High rise buildings are built using uniform spans of steel. That uniformity would be impossible on a spherical earth, as each span of the higher floors would be progressively longer by a small fraction and the walls could never be parallel. As Bowden inadvertently proved, you cannot have parallel building walls on a spherical earth. For example, the World Trade Center Towers, with their parallel and square walls offered silent testimony that the earth is flat. Such buildings could not be built on a spherical earth. Real buildings in the real world have level floors with parallel walls, thus proving that the earth is flat.

The curved bridge illustrated by Bowden exists only in his imagination. There is no such bridge in the real world. How would Bowden explain the flat and level, 23 mile-long, Lake Pontchartrain Causeway? It is not a bridge of his imagination on a mythical spherical earth. It is a real bridge on a real flat earth with real support columns that are perfectly parallel to one another.

How would Bowden explain the Suez Canal?

The Suez Canal is just one example that stands as irrefutable proof that the earth is flat. The canal runs for 100 miles. There are no locks in the canal; it is perfectly level for the entire 100 miles. If the earth were a globe, each end of the canal would necessarily be over one mile below the horizon from the other end. That would mean that the middle of the canal would be elevated in a round hump 1,666 feet in the mid-point of the canal. The actual survey of the Suez Canal proves that the surface of the water is flat for 100 miles from one end of the canal to the other. That flat span of water could only be possible if the earth is in fact flat.

Edward Hendrie

Author of *The Greatest Lie on Earth: Proof That Our World Is Not A Moving Globe*⁸⁶

Malcom Bowden replied to my posted comment as follows:

Malcolm Bowden: REPLY-BRIDGE COLUMNS. His assertion that they are "columns that are perfectly parallel to one another." is NOT based on evidence but upon his THEORETICAL ASSUMPTION of a flat earth!. If he were to measure the two distances from the top of the first and last columns and their bottoms he would find that they are fractionally longer at the top than at the bottom. This is extremely difficult to do so he has NO evidence that I am wrong. Suez Canal - The survey would have been carried out using theodolites which are automatically corrected for the curvature of the earth due to their leveling bubble - AS WITH THE

CONSTRUCTION OF BRIDGES.

MB⁸⁷

Bowden's posted reply alleged that my statement that in the real world bridge columns are perfectly parallel to one another was based entirely on a theoretical assumption of a flat earth. No. My statement was based upon reality. Bridge columns, and indeed building walls, are designed and plumbed to be 90° vertical. The walls and columns are parallel to one another in the real world. I live in the real world and have built buildings and other structures in the real world. In building those structures, I have made sure that the opposing walls were plumbed vertical and parallel to one another. Bowden seems to live in a fantasy world, where buildings have walls that splay out from one another and can never be parallel.

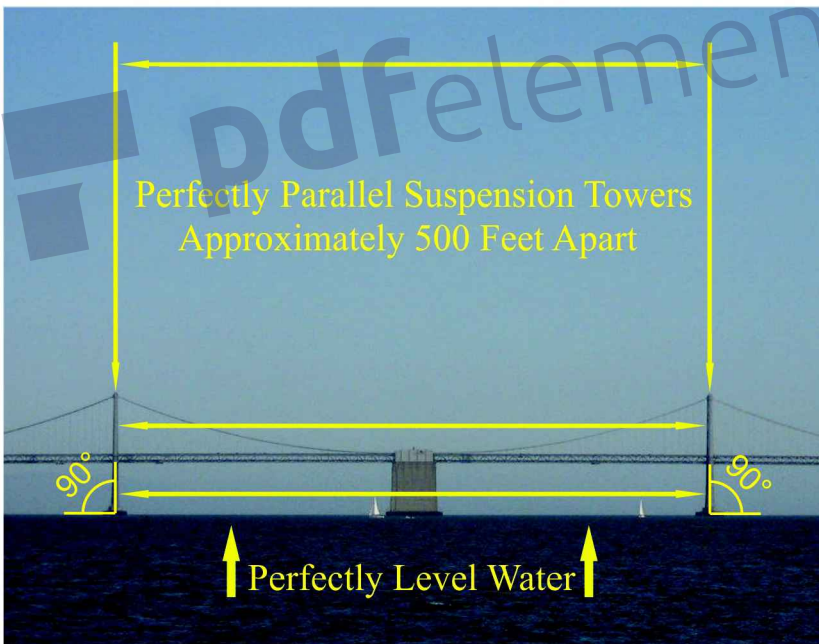

Above is a photograph of a portion of the western span of the San Francisco Bay Bridge. Notice the suspension towers of the

bridge, which are approximately 500 feet apart, are perfectly parallel as they rise 90° vertically above the perfectly level water. There is no indication of any splaying from the surface of the water as Bowden alleges, and indeed would be required if the earth were a sphere. The San Francisco Bay Bridge is what bridges look like in the real world. This bridge, and indeed all bridges in the world, with their parallel, 90° plumbed, vertical suspension towers, testify that the earth is flat.

Nick Berry was “educated as a rocket scientist and aircraft designer, graduating with a Masters Degree in Aeronautical and Astronautical Engineering.”⁸⁸ He has an internet blog called DataGenetics in which he claims that “because of the curvature of the Earth, the towers [on the Golden Gate Bridge] are a little wider apart at the top than at the bottom.” Below is the image Berry posted showing his concept of the Golden Gate Bridge on a spherical earth. Berry calculated that the bridge towers should be 46.2 mm, (1 and 13/16 inches) wider apart at the top than at the bottom. Berry states: “The top of the Golden Gate Bridge is almost two inches wider at the top than the base because of the curvature of the Earth! Tell everyone in the car this next time you drive over it!”⁸⁹

Below is a diagram depicting his conception. $l = 1,280$ meters and $l + x = 1,280.0462$ meters.

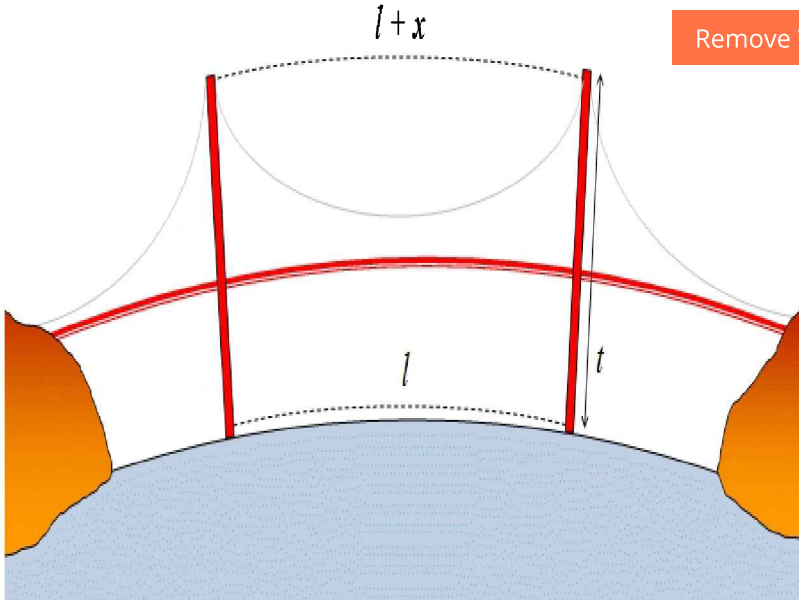

Figure 42: Nick Berry's depiction of his misconception of the splaying out of the Golden Gate Bridge Towers.

The suspension on the Golden Gate Bridge towers were precisely 4,200 feet apart, which is the equivalent of approximately 1,280 meters. Berry's calculations are based upon the false premise that the earth is a sphere (he clarifies that he thinks that the earth is actually an oblate spheroid). I checked Berry's trigonometric calculations and obtained a slightly different answer of 1.55 inches (approximately 1 and 9/16 inches) for the added distance between the top of the towers and the bottom. The difference in our calculations may be due to the fact that I assumed a radius of the earth of 3,963 miles, whereas Berry assumed a radius of 3,959 miles (6,371 kilometers). It makes no difference anyway, since the earth is not a globe, and thus both figures are mythical.

As with Bowden, Berry seems to be living in a fantasy world. In the real world, the real Golden Gate Bridge does not have suspension towers that splay out. The suspension towers on

the Golden Gate Bridge that exist in the real world are perfectly parallel. Real engineers who were responsible for building the real Golden Gate Bridge created diagrams that clearly depict parallel suspension towers. The real engineers made no adjustments for a mythical, spherical earth. Indeed, the official website of the Golden Gate Bridge Highway & Transportation District depicts the spans of the Golden Gate Bridge at the top as being 4,200 feet (1,280 meters) apart.⁹⁰ There is no indication of any compensation for a spherical earth. Indeed, the engineering blue prints depict perfectly parallel suspension towers constructed 90° vertical from their bases.

The diagram of the Golden Gate Bridge below is from the June 22, 2012 engineering study titled, *Engineering the Golden Gate*, by Sarah L. Billington, Associate Professor Dept. of CEE, Stanford University, and David P. Billington, Jr., Historian & Independent Scholar.⁹¹ The diagram was created by the Board of Engineers for the Golden Gate Bridge project, Leon Moisseiff, Joseph Strauss, Othmar Ammann, and Charles Derleth Jr.



Figure 43: Diagram of the real Golden Gate Bridge over perfectly level water on a flat earth.

Notice that the diagram depicts a perfectly level mean high water mark. It also depicts a slight ten foot bow upward in the center of the bridge as measured against the perfectly level mean high water mark. If there were any bow in the earth and resulting

splaying in the towers, the drafters would have indicated that, just as they indicated the bowed roadway on the bridge. The suspension towers are perfectly perpendicular to the level water. The towers are perfectly plumb and parallel to each other. Notice also that the vertical support cables are also perfectly vertical and perfectly parallel with one another.

Nick Berry's spherical earth construct cannot hold up to scrutiny. The towers on the Golden Gate Bridge are diagramed by the design engineers as parallel to one another. If one reads any treatise on bridge building, one finds that all bridges across water are constructed assuming that the water is perfectly flat and that the bridge columns will rise precisely plumb and perpendicular to the water.⁹² The towers are always diagramed as being parallel to one another. That is because that is how bridges are in fact built on a flat earth.

Below is a diagram from the Akashi Kaikyo Bridge, which is the world's longest suspension bridge. There are 1,991 meters (6,532 feet or 1.24 miles) between the suspension towers. The massive towers stand 282.8 meters (928 feet) in height over the water. Notice the measurement given for the distance between the towers in the diagrams is given from the top of the towers. That indicates that the engineers expected that there would be no deviation from the distance at the surface of the water, from which they would begin the construction of the towers. The engineers planned for the towers to be vertically plumb and parallel

Berry's point in calculating the supposed difference in the distances between to the tops of the towers on the Golden Gate Bridge was to argue that the difference is so slight as to be insignificant. What may seem slight can be quite significant when put under the immense stress carried by the bridge suspension towers. For example, the builders of the Akashi Kaikyo Bridge built the bridge suspension towers perfectly vertical with exacting tolerances. They had to set the base caissons within 10 centimeters

(3.9 inches) of perfectly level. The immense stresses placed upon the towers required that the towers be built vertically plumb. The Sumitomo Group Public Affairs Committee website explains just how carefully the builders were in ensuring that each tower was built perfectly vertical. “If the caissons were placed even slightly off level, the towers would not stand vertically; so the foundations had to be set on the seabed at a depth of 60 meters, horizontal to less than a 10-centimeter margin of error.”⁹³

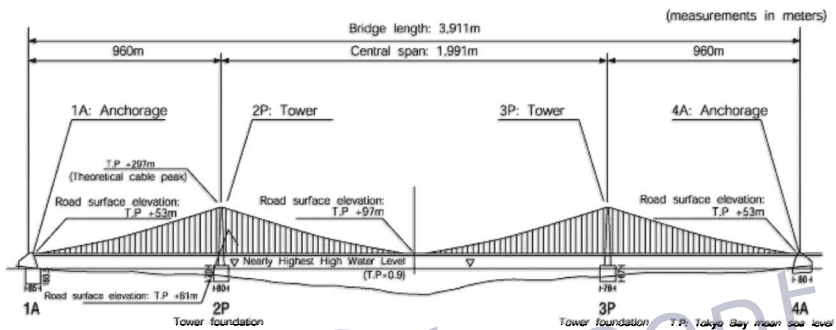

Figure 44: Diagram of the Akashi Kaikyo Bridge showing perfectly parallel suspension towers perpendicular over flat level water.

The seabed had to be leveled and the caissons for the towers had to be laid horizontal with the level seabed, with less than 10 centimeters (3.9 inches) as the margin of error. Otherwise, the bridge would be out of specification. Apparently, the towers could only be adjusted 3.9 inches at their base to make up for any slight error in laying the caissons.

Assuming the earth is a globe, we find by using trigonometry that the Akashi Kaikyo Bridge towers would be 3.17 inches further apart at the top than at the bottom. Suspension bridge towers are designed to withstand massive downward compression loads, but they are not designed for massive lateral loads. If the towers are not vertically plumb and parallel, it would put added lateral stress on the towers.

If the earth were a sphere, no walls on any buildings or columns on any bridges would be parallel. The fact that all walls on square buildings and all columns on bridges built in the real world are designed and built to be parallel is proof that the earth is flat.

Malcolm Bowden presents his theoretical assumption that bridge columns (and by necessity all building walls) are wider apart at the top than they are at the bottom, due to the curvature of the earth. Being a civil engineer, Bowden knows that the splaying out of the columns needs to be true if the world is a sphere. He also knows that if it is not true, then the earth must be flat. He simply cannot accept that the earth is flat, and so he must necessarily accept the fiction that there are not, and indeed cannot be, any parallel bridge columns or building walls. The fact that his belief is not supported by the real world evidence proves his spherical earth construct is wrong.

Bowden's artifice is unsupportable by observable evidence. For example, below is a picture of the New York skyline. It is clear to see that the skyline is perfectly level. This is confirmed by the fact that the vertical walls on the buildings that are more than a mile apart are parallel to one another. The walls and floors of all buildings are built using levels. Levels create perfectly plumb vertical walls. The fact that the plumb vertical walls are also perfectly parallel means that the earth cannot be a sphere.



In the above picture of the New York skyline, the lines placed along the side of the vertical walls of the buildings more than a mile apart have been extended past the height of the antenna at the top of the Freedom Tower. The tip of the antenna is 1,792 feet in height above the ground. If the earth were a globe, the vertical lines running from the walls would not be parallel (as they in fact are), but would be splayed apart at an angle of approximately $.015^\circ$, which is approximately one minute of arc. If the earth were a sphere, the extended vertical lines would be splayed out a distance of approximately 5.43 inches further apart at the height of the antenna than at ground level. But that is not what we see; what we see is that the vertical lines remain perfectly parallel. Indeed, the vertical lines could be extended to infinity and they would remain perfectly parallel, thus indicating that the earth is flat.

Even in the unusual case when a building is designed with angled walls (like the Freedom Tower depicted in the photograph above), the floors on such buildings are always horizontally level and parallel to the ground, as well as being horizontally parallel to all floors on other buildings.

With some exceptions (like the Freedom Tower), almost all buildings have walls that are perpendicular (90° vertical) to level ground. The fact that almost all buildings are designed with walls that are plumbed vertical, and that age old construction method results in the opposing walls being perfectly parallel to one another, can mean only one thing: the earth is flat.

The Freedom Tower, which is the tallest building depicted in the picture above, was built to replace the destroyed World Trade Center Towers. The original blueprints of the North Tower of the World Trade Center were leaked to the media in 2007 by a whistle-blower.⁹⁴ Those blueprints prove both that the earth is flat and that the 2002 FEMA Performance Study⁹⁵ and the 2005 NIST Report⁹⁶ on the collapse of the twin towers were deceptive

coverups. Read this author's book, *9/11 - Enemies Foreign and Domestic*, for more details on the who, how, and why of the 9/11 attacks. 9/11 attack researchers Jim Hoffman, Gregg Roberts, and Jan Hoyer explain that "[t]he blueprints to the Twin Towers and Building 7 remained off-limits to the public for more than five years after the attack [until they were leaked], despite the fact that the buildings were built with public money and that the engineering drawings of public buildings are supposed to be public information."⁹⁷

Hoffman, Roberts, and Hoyer explain that the blueprint drawings contain a wealth of detail about the buildings, including the dimensions of the structural members. The original blueprints of the North Tower reveal that the FEMA and NIST reports were misleading regarding the massive core columns. The FEMA and NIST reports gave the false impression that the twin towers were weakly constructed.

Both of the government-sponsored engineering studies of the Twin Towers' "collapses" -- FEMA's and NIST's -- are highly misleading about the core structures. Neither FEMA's Study nor NIST's Report discloses dimensions for core columns -- dimensions that are clearly evident in the architectural drawings. Both Reports use a variety of techniques seemingly designed to minimize the strength of the cores or to conceal their structural role entirely. So effective was FEMA at concealing the nature of the cores that the 9/11 Commission Report, citing the FEMA Report, denied the very existence of the core columns.⁹⁸

The blueprints of the WTC North Tower also prove that the earth cannot be a sphere and must be flat. How could blueprints of a building prove that the earth is flat? Because the blueprints show that the North Tower was built as a perfectly square cuboid (with each corner chamfered 6 feet 11 inches). The blueprints show that the horizontal width for each side of the building was precisely 207 feet, 2 inches. That dimension ran from the bottom to the top of the building.⁹⁹



Figure 46: World Trade Center Towers. The North Tower is on the left with the antenna.

The North and South World Trade Center Towers were sister towers, with exactly the same exterior dimensions. The North and South Tower buildings were both 110 stories tall. The North Tower rose 1,368 feet from the ground to its roof. Other than their corner chamfers, the Twin Towers were perfectly square cuboids. The North Tower had exactly the same dimensions, with each side of the building being 207 feet, 2 inches wide, at the 110th floor, 1,368 feet above the ground, as it did at the first floor at ground level. Such an occurrence would not be possible if the earth were a globe.

Using trigonometry, we find that if the earth were a sphere the 110th floor should have been splayed out from the base by .16 inches (almost 3/16 of an inch). One might think that 3/16th of an inch is not very much of a difference in width between the first floor and the 110th floor. But when one realizes that the tower was built using massive steel girders that were prefabricated offsite in uniform dimensions with preset holes, it becomes clear that the

tower could not be built with any deviation in floor dimension. That is because the holes for the bolts and rivets must line up perfectly in order for the structure to be assembled. The holes on the girders would line up perfectly on the ground floor, but they would be almost 3/16 of an inch off center by the time the steel workers reached the 110th floor. Indeed, this problem would gradually manifest itself long before the steel workers ever reached the 110th floor. The girders could not be assembled, because the holes for the bolts and rivets would not line up and steel girders do not stretch. Indeed, this would be an issue for all four walls of the building, as the splaying outward of the walls and corners would be in all directions on each floor.

The 110 story World Trade Center Towers, with their perfectly parallel, vertically plumb walls, could not be built on a spherical earth. The architectural diagrams for the North Tower indicate that it was designed to have each side of each successive floor measure horizontally precisely 207 feet, 2 inches. There is no indication in the architectural drawings for a 3/16 inch allowance for the splaying out of the walls as the tower rose from the ground of a supposedly spherical earth to the 110th floor. The blueprints list the dimensions of every single one of the 110 floors as having a horizontal measure of precisely 207 feet, 2 inches. Such could only be the case on a flat earth.

Engineer W. Winckler stated that no construction engineer would dream of allowing for the curvature of the earth.¹⁰⁰ For example, Brian Mullin is a professional civil and structural engineer, who has been practicing for ten years and is licensed in four states.¹⁰¹ Mullin stated in July 2016 that “[s]ome people think it [the idea of a flat earth] is ridiculous, but a lot of engineers and surveyors out there have really started to ask questions. They have started to realize that there aren’t answers to these things. That we ignore the alleged curvature and rotation of the earth all the time and we never have any error because of it.”¹⁰²

What Mullin says is true. No engineer takes into account curvature of the earth, because to do so would be to take into account something that does not exist. Yolanda Whittle responded to Mullin's comment by stating, that during her two years as a surveying crew chief "we NEVER took curvature into effect."¹⁰³ (emphasis in original) Whittle stated that she is licensed in 3 states as a professional civil engineer. She further stated that "[w]e did make adjustments for the lens refraction on long jobs, but doing many traverse surveys over long roads, I never saw any curvature or deducted for curvature. When I started, I even asked the head licensed surveyor [with] over 25 yrs [experience], and he said that it's never used. That should tell you everything you need to know!"¹⁰⁴

David Barnard Steinman, Ph.D., was a brilliant structural engineer who designed and built bridges in the United States, Thailand, England, Portugal, Italy, Brazil, Haiti, Puerto Rico, Canada, Korea, Iraq and Pakistan. He was awarded the Franklin Institute's Louis E. Levy Medal in 1957 for his design of the Mackinac Bridge.¹⁰⁵ Dr. Steinman wrote an authoritative book on constructing bridges titled, *A Practical Treatise on Suspension Bridges*.¹⁰⁶ Nowhere in his painstakingly thorough and precise treatise on bridge design and construction does he ever mention making an allowance for the supposed curvature of the earth.

In the fantasy world in which Malcom Bowden and Rick Berry live, they can make things up and say that an allowance must be made for the earth's curvature. They can get away with it, because they do not actually design or build anything. Engineers who design real buildings can't just make things up. In the real world, engineers who design structures that are actually built, must be accurate and precise. There is not a construction blueprint for any building or bridge, no matter how large the structure, that makes any allowance for (or even any mention of) the supposed curvature of the earth. That is because the earth is flat.

7

Airplane Level Flight Proves the Earth is Flat

If the earth were a globe, airliners would not be able to fly on a flat and level path. Any pilot will tell you that once a plane gets to its cruising altitude, the pilot “levels off” and flies in a straight and level path. Indeed, the pilot uses the horizon to ensure that the plane is flying level. When visibility is poor, the pilot will use the instruments and fly a level heading, using an artificial horizon. Either way, at all times the plane flies level, once the pilot reaches cruising altitude. If the earth were a globe, the pilot would have to constantly adjust the heading of the plane and dip its nose down to keep a constant altitude. However, the earth is in fact flat, so if a pilot dipped the nose of the plane down, to adjust for the supposed curvature of the earth, he would find that he is losing altitude. If the pilot kept on that downward trajectory, the plane would crash into the earth. The fact that no such downward adjustment is made by pilots for the supposed curvature of the earth is proof that the earth is flat. Eric Dubay explains:

If the Earth were a sphere, airplane pilots would have to constantly correct their altitudes downwards so as to not fly straight off into “outer space!” If the Earth were truly a sphere 25,000

miles circumference curveting 8 inches per mile squared, a pilot wishing to simply maintain their altitude at a typical cruising speed of 500 mph, would have to constantly dip their nose downwards and descend 2,777 feet (over half a mile) every minute! Otherwise, without compensation, in one hour's time the pilot would find themselves 166,666 feet (31.5 miles) higher than expected! A plane flying at a typical 35,000 feet wishing to maintain that altitude at the upper-rim of the so-called "Troposphere" in one hour would find themselves over 200,000 feet high into the "Mesosphere" with a steadily raising trajectory the longer they go. I have talked to several pilots, and no such compensation for the Earth's supposed curvature is ever made. When pilots set an altitude, their artificial horizon gauge remains level and so does their course; nothing like the necessary 2,777 foot per minute declination is ever taken into consideration.¹⁰⁷



Indeed, the Federal Aviation Administration (FAA) assumes a flat earth when training pilots and air traffic controllers using their Target Generation Facility (TGF). The TGF consists of several software programs that control simulation scenarios, using simulated aircraft. The TGF computer simulator drives almost all of the air traffic control laboratories at the FAA William J. Hughes Technical Center.¹⁰⁸ The FAA states: “Our lab has worked closely with the TGF group to have aircraft perform the way air traffic controllers would expect them to behave in the real National Airspace System (NAS). The simulated aircraft in TGF are quite realistic representations of their real-life counterparts.”¹⁰⁹

The software used in the TGF must be accurate in order to properly train pilots and air traffic controllers on the behavior of aircraft in flight. The assumption of a flat earth can be seen in a publication from the FAA, *The Engineering Analysis and Design of the Aircraft Dynamics Model For the FAA Target Generation Facility [TGF]*. That FAA publication explains the software that is used by the TGF to accurately simulate the behavior of aircraft over the earth.

Specifically, this document discusses the detailed engineering design and software implementation of an Aircraft Dynamics Model (ADM) suitable for incorporation into the FAA TGF simulations at the FAA William J. Hughes Technical Center, Atlantic City, NJ. The model is designed to be implemented on computers located within the facility, and to work in conjunction with software models of radar, data links, and other Air Traffic Management (ATM) equipment to provide realtime simulation of aircraft operating within the National Airspace System (NAS).¹¹⁰

The FAA publication explains that in order for the

software to accurately replicate the behavior of aircraft during flight over the earth, the software running the TGF simulator assumes that the earth is flat.

The observant reader will notice that the aircraft equations of motion were calculated **assuming a flat Earth** and that we here assume the development frame was the NorthEast-Down frame. This implies necessarily that **earth rotation and the variation of the gravity vector with position over the earth were ignored** in developing the aircraft equations of motion. This simplification limits our mathematical model to the flight of aircraft only. The model will not properly handle the flight of sub-orbital craft and spacecraft such as intercontinental ballistic missiles, satellites, or the space shuttle. The model is adequate for all vehicles traveling under Mach 3.¹¹¹ (emphasis added)

Notice that the FAA document both assumes a flat earth and ignores the rotation of the earth and gravity. The FAA maintains that the computer model assumes a stationary, flat earth and at the same time remains precise and accurate regarding the flight of aircraft. The only way that a stationary, flat earth can be the basis for a model, and that model still be accurate, is if the earth is in fact flat and stationary. That means that the ignored gravity and rotating, globular earth do not affect the accuracy of the model, because they do not in fact exist in reality.

The proviso in the last sentence that the computer model does not address spacecraft or satellites is meaningless surplusage. The statement that the model is adequate for all vehicles traveling under Mach 3 is also meaningless, since it does not specify that it would be inaccurate for vehicles traveling over Mach 3.

The entire purpose of the TGF simulation is to create as real a simulation of actual aircraft flight over the earth as is possible. The only way to do that is to simulate what is real. That is why the TGF software assumes a flat earth. The TGF is designed to have “high fidelity” to reality. The FAA publication states:

Currently, the aircraft dynamics incorporated in the TGF are based on the first principles of physics and aeronautics. The models provide the performance characteristics needed to support **high fidelity simulations**. The TGF incorporates fuel burn models environmental (weather) effects. Additionally, the modeled aircraft are representative of commercial air traffic in the US National Air Space (NAS). As future simulations are developed or brought to the Technical Center, **higher fidelity will be required to identify NAS operational safety and performance issues**. The TGF is prepared to increase its fidelity and operational connectivity required to meet the demands by the other FAA programs and simulators. **The goal of this project has been to develop and maintain a high-fidelity simulation** capability to meet the needs of the FAA in operating, testing, and evaluating its NAS.¹¹² (emphasis added)

The reality to which the TGF software is faithful is that the earth is stationary and flat. If the TGF simulator based its model on the false premise of a globular, spinning earth, it would create a safety issue for aircraft. The FAA simply had to assume a flat earth, because that is reality. If the FAA had assumed a spinning, spherical earth model, the pilots and air traffic controllers would be trained improperly and create the messy and embarrassing result of planes crashing with regularity.

Indeed, since safety is paramount, it was necessary for the FAA to verify, with real-life testing, the algorithms in the TGA simulator that assume a flat, stationary earth. The FAA publication states that “[t]he document concludes with a section on verification and validation, the process by which the various features of the simulation are tested and verified.”¹¹³ What did the section on verification reveal? The FAA publication reports that “[t]he testing that was done to verify and validate the TGF simulation gives us a high degree of confidence that the models contained herein have sufficient fidelity for use as a target generating tool.”¹¹⁴ The models that the testing validated as being faithful to reality to a high degree of confidence assumed a flat, stationary earth. That means that the FAA verified, through actual testing with aircraft, with a high degree of confidence, that the earth is flat and stationary.

The U.S. Government implicitly acknowledged the reality of the flat, stationary earth in another official publication. In NASA’s 1988 publication (#1207) titled *Derivation and Definition of a Linear Aircraft Model*, it states that the generally accepted linear aircraft model is based upon “a rigid aircraft of constant mass flying over a flat, nonrotating earth.”¹¹⁵

Every commercial and military aircraft has onboard an instrument that can only work on a flat earth. That instrument is the attitude indicator, which is also known as an artificial horizon. That artificial horizon instrument has a display, that shows the pilot the attitude of the plane to the actual horizon, even if he cannot see the horizon because it is obscured by inclement weather or darkness. The pilot can determine the roll of the aircraft, (i.e., if he is flying level) and the pitch of the aircraft (i.e., if the nose of he aircraft is pointed below or above the horizon). That attitude indicator works by means of a spinning gyroscope mounted on a gimbal.

A gyroscope has two important properties: 1) rigidity in

space, and 2) precession. All practical applications of gyroscopes are based on these two properties. Precession means that the gyro will resist any force that attempts to change its plane of rotation. A force applied to the gyro will result in a movement of the gyro, but not in the direction of the applied force. The gyro will instead move at right angles to the direction of the applied force. The rate of precession is in direct proportion to the applied force.

The most important property of a gyroscope for a pilot is rigidity in space. That means that a gyroscope will retain its horizontal attitude parallel to the direction of the spin of its rotor and retain its vertical attitude in relation to its rotor's axis. The rotor's axis around which it spins is the y axis (vertical); the horizontal plane of the rotor is on the x (lateral) axis and the z (depth) axis. Thus, if the spinning gyroscope is on a gimbal that allows for rotation along three axes (x, y, and z), the gyroscope will retain its original attitude in relation to the x, y, and z axes, and the gimbal will move around the fixed gyroscope. The x, y, and z axes of the gyroscope will remain rigid in space, offering a fixed matrix upon which the airplane can move. Any difference between the fixed axes of the gyroscope and the moving airplane will show up in the coordinates on the attitude indicator instrument. That is what the gimbal attached to the aircraft in the instrument bay allows, as illustrated in the following frames from a U.S. Navy training film produced in the 1960s, explaining how gyroscopic flight instruments work.

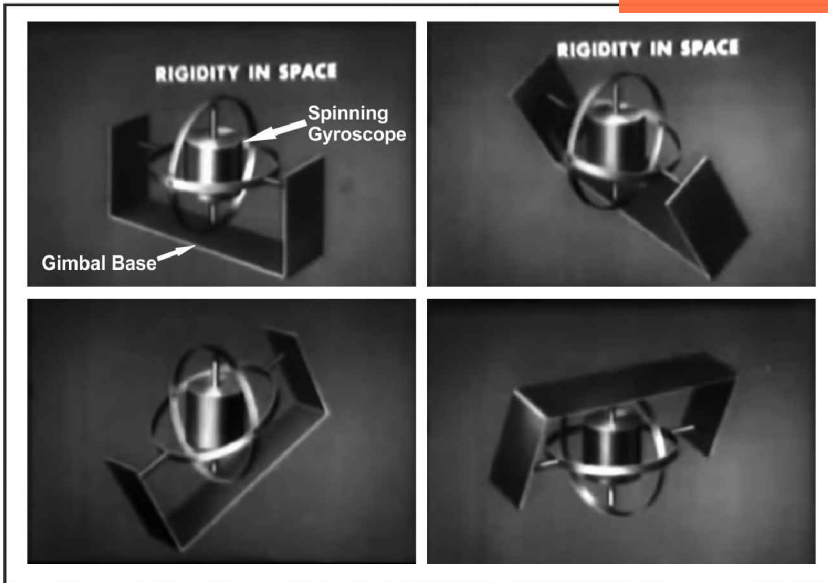

The spinning gyroscope in the attitude indicator stays fixed and rigid in space. The gimbal in the attitude indicator instrument allows for the aircraft to move in relation to the fixed axes (x, y, and z) of the spinning gyroscope. Thus the pilot can see by looking at the attitude indicator instrument the exact attitude of his plane in relation to the horizon.

The problem with the spherical earth model is that a plane with a attitude indicator showing straight and level flight will cause the plane to fly off into the upper atmosphere as the curve of the globe falls away from the aircraft. The only way that a pilot on an aircraft can fly a straight and level path using his attitude indicator is on a flat earth.

Below is a frame from a United States Navy training film, circa 1960.¹¹⁶ The frame illustrates the inherent impossibility of maintaining level flight for an aircraft using gyroscopic instruments on a spherical earth. The gyroscope depicted in the frame is seen to maintain its rigidity in space as it hypothetically circumnavigates the globe. As is obvious by the rigid attitude of the gyroscope, a plane with a gyroscopic attitude indicator would be gradually heading out toward the upper atmosphere as it



traversed the globe. Indeed, as indicated in the film illustration, the plane would be in a vertical trajectory after flying one quarter of the circumference of the earth, a distance of approximately 6,250 miles.

Incidentally, the training film narrator tried to explain away this apparent problem by stating that there is a continuous adjustment to the attitude of the gyroscope built into the attitude indicator instrument. However, the mythical, on-the-fly adjustment to the gyroscope is impossible, as such an adjustment would render the gyroscope useless. Recall that the fundamental property of a gyroscope is that it maintains its rigidity in space. If the fundamental property of a gyroscope (rigidity) can be so easily altered, that means that rigidity is not truly a fundamental property of a gyroscope. An adjustment to the fundamental characteristic of rigidity in space of the gyroscope, if it were possible, would defeat the whole reason to use the gyroscope. It would make no sense to use an instrument with a gimbaled gyroscope that would require an additional feature to neutralize the primary property of the gyroscope (rigidity). The supposed neutralizing feature of the

instrument would need to detect the precise curvature of the supposedly ball earth and maintain a true course over its surface. If it could do all of that, why add the complication of a gimbaled gyroscope? An attitude indicator with gimbaled gyroscope would only be a hindrance on a ball earth.

Rigidity in space is exactly the opposite of what is called for in an attitude indicator on a spherical earth. A gyroscopic attitude indicator instrument is necessary on a flat earth, but that same instrument would be pointless, and even dangerous, on a spherical earth.

A gyroscopic attitude indicator keeps its attitude precisely perpendicular on its axis, on a fixed plane to the spin of its rotor, and perfectly level in relation to the surface of the earth, because the earth is flat. The rigidity in space of a moving gyroscope that maintains its attitude is only useful in an attitude indicator on a flat earth. A gyroscopic attitude indicator simply will not work on a globe.

One interesting thing revealed in the above illustration from the United States Navy Training Film, is the fact that if the earth were a spinning globe, a gyroscope in a gimbal placed on a level table should show the spin of the earth. Thus, if the earth were spinning, the gimbal surrounding the gyroscope would show a movement of 1.25 degrees within 5 minutes and 15 degrees in one hour. As the United States Navy Training Film illustrates, after 6 hours, the gimbal should turn 90 degrees underneath the gyroscope on a spinning globe. Such an experiment using a gimbaled gyroscope has been performed. The experiment showed no movement whatsoever of the gimbal around the gyroscope, thus proving that the earth is not a spinning globe.¹¹⁷

8 **Horizon Is Always Flat**

The evidence of a flat earth is easy to discern, once a person perceives what he is seeing around him. The horizon is always seen to be flat over water. That proves that the earth is itself flat, otherwise the horizon would be bowed. B. Charles Brough explains:

The marine horizon, from whatever position it is viewed, always appears to be, and is, in fact, a perfectly level line, and since this appearance is the same in all parts of the world, its surface must be level; and therefore the Earth is a Plane. This may be proved to be the case, by erecting at a suitable elevation on the sea shore, a duly-levelled board, or a string - at right angles to a plumb-line - tightly stretched between two vertical poles. On looking towards the sea, the horizontal line for a distance of 20 miles may be easily observed, and throughout its entire length it will be found to coincide with the straight-edge, or string; but if the earth were a globe, the horizontal line would form an arc of twenty miles in length, curveting both ways from the center, at the rate of eight inches, multiplied

by the square of the distance. Hence the horizontal line at either end of the distance ought to be depressed some 66 feet below the horizon in the center. But as no such appearance is ever presented, it necessarily follows that the earth cannot be a globe, or other than a plane.¹¹⁸

Samuel Rowbotham proved the correctness of Brough's statement. Rowbotham stated:

It is known that the horizon at sea, whatever distance it may extend to the right and left of the observer on land, always appears as a straight line. The following experiment has been tried in various parts of the country. At Brighton, on a rising ground near the race course, two poles were fixed in the earth six yards apart, and directly opposite the sea. Between these poles a line was tightly stretched parallel to the horizon. From the center of the line the view embraced not less than 20 miles on each side making a distance of 40 miles. A vessel was observed sailing directly westwards; the line cut the rigging a little above the bulwarks, which it did for several hours or until the vessel had sailed the whole distance of 40 miles. The ship coming into view from the east would have to ascend an inclined plane for 20 miles until it arrived at the center of the arc, whence it would have to descend for the same distance. The square of 20 miles multiplied by 8 inches gives 266 feet as the amount the vessel would be below the line at the beginning and at the end of the 40 miles.¹¹⁹

Indeed, Rowbotham presents graphic proof that the earth is flat, simply by looking at the sea horizon. His proof can be

replicated by anyone.

The sea horizon, to whatever distance it extends to the right and left of an observer on land, always appears as a perfectly straight line, as represented by H, H [in the figure below].



Not only does it appear to be straight as far as it extends, but it may be proved to be so by the following simple experiment. At any altitude above the sea-level, fix a long board--say from 6 to 12 or more feet in length--edgewise upon tripods, as shown in [the figure below].



Let the upper edge be smooth, and perfectly levelled. On placing the eye behind and about the centre of the board B, B, and looking over it towards the sea, the distant horizon will be observed to run perfectly parallel with its upper edge. If the eye be now directed in an angular direction to the left and to the right, there will be no difficulty in observing a length of ten to twenty miles, according to the altitude of the position; and this whole distance of twenty miles of sea horizon will be seen as a perfectly straight line. This would be impossible if the earth were a globe, and the water of the sea convex. Ten miles on each side would give a curvature of 66 feet ($10^2 \times 8 = 66$ feet 8 inches), and instead of

the horizon touching the board along its whole length, it would be seen to gradually decline from the centre C, and to be over 66 feet below the two extremities B, B, as shown in fig. 18. Any vessel approaching from the left would be seen to ascend the inclined plane H, B, C, and on passing the centre would descend from C towards the curvating horizon at H. Such a phenomenon is never observed, and it may be fairly concluded that such convexity or curvature does not exist.¹²⁰



Rowbotham presents further evidence that the earth is flat by observation of a specific coastline in Great Britain. The observations he made regarding the flatness of the coastline of North Wales can be replicated today. Anyone today can view the coastline of North Wales from the Isle of Man and confirm that the earth is flat, just as Rowbotham did in 1881.

From the high land near Douglas Harbour, Isle of Man, the whole length of the coast of North Wales is often plainly visible to the naked eye, a distance extending from the point of Ayr, at the mouth of the River Dee, towards Holyhead, not less than fifty miles. Whatever test has been employed, the line, where the sea and the land appear to join, is always found to be perfectly horizontal, as shown in the following diagram; fig. 21, whereas, if the earth is spherical, and therefore the surface of all water convex, such an appearance could not exist. It would of necessity appear as shown in fig. 22. A line stretched

horizontally before the observer would not only show the various elevations of the land, but would also show the declination of the horizon H, H, below the cross-line S, S. The fifty miles length of the Welsh coast seen along the horizon in Liverpool Bay, would have a declination from the centre of at least 416 feet ($25^2 \times .8$ inches = 416 feet 8 inches). But as such declination, or downward curvature, cannot be detected, the conclusion is logically inevitable that it has no existence. Let the reader seriously ask whether any and what reason exists in Nature to prevent the fall of more than 400 feet being visible to the eye, or incapable of detection by any optical or mathematical means whatever. This question is especially important when it is considered that at the same distance, and on the upper outline of the same land, changes of level of only a few yards extent are quickly and unmistakably perceptible. If he is guided by evidence and reason, and influenced by a love of truth and consistency, he cannot longer maintain that the earth is a globe. He must feel that to do so is to war with the evidence of his senses, to deny that any importance attaches to fact and experiment, to ignore entirely the value of logical process, and to cease to rely upon practical induction.¹²¹



Fig. 21: The flat coastline of North Wales as viewed from the high land near Douglas Harbour, on the Isle of Man. The coastline of North Wales is approximately 50 miles in length and approximately 70 miles distance from the Isle of Man.



Fig. 22: The coastline of North Wales from the high land near Douglas Harbour, on the Isle of Man, as it would appear if the earth were a globe. Most of the coastline would be below the horizon (points S, S), and further the coastline would be curved laterally, with a 416 foot, 8 inch, bow at the middle, from the two points H, H. This, however, is not what is seen, thus proving that the earth is not a globe.

pdfelement

9 Flat Horizon is Always At Eye Level

Not only is the horizon always flat to the observer, but it always rises to eye level with the observer who takes flight, no matter how high the observer ascends. If the earth were a globe, the lateral horizon would be bowed and it would drop below the eye level of the observer as he ascended above the earth. Eric Dubay explains:

Whether at sea-level, the top of Mount Everest, or flying over a hundred thousand feet in the air, the always horizontal horizon line always rises up to meet the eye-level of the observer and remains perfectly flat. You can test for yourself on a beach or hilltop, in a large field or desert, aboard a hot-air balloon or helicopter; you will see the panoramic horizon ascend with you and remain completely level all around. If the Earth were actually a big ball, however, the horizon should sink as you ascend, not rise to your eye-level, and it would dip at each end of your periphery, not remain flat all around. Standing in a rising balloon, you would have to look downwards to the horizon; the highest point of the ball-Earth would be directly beneath you and declining on

each side. ... J. Glaisher wrote in his, "Travels in the Air," that "On looking over the top of the car, the horizon appeared to be on a level with the eye, and taking a grand view of the whole visible area beneath, I was struck with its great regularity; all was dwarfed to one plane; it seemed too flat."¹²²

Samuel Rowbotham illustrates that if the earth's surface were convex, as it would need to be on a globe, a balloonist, instead of seeing the horizon remain at eye level as the balloon ascends, the horizon would drop down, requiring the balloonist to look down to see the horizon.¹²³ However, that is not what the balloonist sees. The balloonist sees the horizon always at eye level.

Rowbotham illustrates in the image below that "[i]n the case of the balloon at an altitude of two miles, the horizon would have been 127 miles away, and more than 10,000 feet below the summit of the arc of water underneath the balloon, and over 20,000 feet below the line of sight A, B, as shown in [the below figure]; and the dip C, H, from C, B, to the horizon H, would be so great that the aëronaut could not fail to observe it; instead of which he always sees it 'on a level with his eye,' 'rising as he rises,' and 'at the highest elevation, seeming to close with the sky.'"¹²⁴

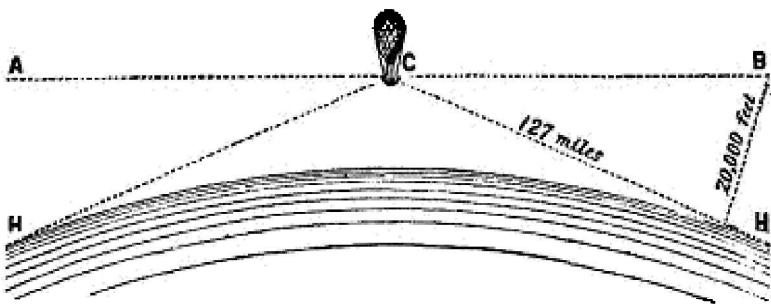

Today, any passenger on a commercial airplane can see the very same phenomenon as a balloonist. The horizon of the earth remains at eye level from the point of the plane's takeoff to its cruising altitude of 30,000 feet. If the earth were a globe, the horizon would drop below the view of the observer on the airplane. The fact that the passenger sees the horizon always at eye level is proof positive that the earth is a flat plane. Eric Dubay explains the recent appearance of photographic trickery used in producing curved earth depictions in NASA and other high altitude photographs.

Amateurs have sent balloons to heights of over 121,000 feet and you can watch video online of the horizon rising with the camera-level and remaining perfectly flat 360 degrees around. NASA videos and other "official" sources, however, such as the recent Red Bull skydive at 128,000 feet have been caught adding fake curvature to the Earth via wide-angle lenses and post-production work. Panoramic photos atop Mount Everest also often claim to be displaying Earth's curvature, but this is simply the result of distortions and limitations inherent in wide-angle lenses.¹²⁵

Dubay's allegation of the misleading depictions of a globular earth by NASA and the controlled media is demonstrated by the two pictures of the earth below. The picture on the top was taken by NASA Commander Scott Kelly, purportedly while he was aboard the International Space Station (ISS).¹²⁶ The space-based ISS almost certainly does not exist; the below picture was likely taken from a high altitude aircraft. The camera and wide-angle, fish eye lens used by Commander Kelly is depicted inset in the top photo; Commander Kelly himself supplied that picture of the camera. Adobe Photoshop has a feature that allows one to

input the kind of camera and type of lens, the software will then automatically adjust the distortion caused by the fish eye lens. A photographic expert did that very thing, and the result is a perfectly flat horizon, as revealed in the bottom picture, below. Notice the hot spot caused by the sun, which indicates that the sun is close overhead and much smaller than the earth.

 pdfelement



Dubay's allegation that the depictions of a spherical earth by NASA and the controlled media are misleading can be further verified by watching the Red Bull sponsored world record skydive

of Felix Baumgartner. Before Baumgartner exited his capsule suspended by a balloon at approximately 128,000 feet above the earth, a camera with an ordinary lens shows the flat, eye level horizon of the earth. The picture states a height of 127,518 feet, because it was taken a few minutes before the jump; the balloon continued to ascend to the jump height of over 128,000 feet. If the earth were a globe, the horizon should not have been visible at eye level at 127,518 feet above the earth.



When Baumgartner steps out of the balloon's capsule, and the video is switched to the exterior GoPro camera, suddenly the flat horizon is transformed into a curved horizon. The curved horizon is depicted, because the exterior GoPro camera used a wide angle, fish eye lens, which caused the earth's horizon to appear bowed.



Below is a picture shortly after Baumgartner jumps from the capsule. Notice the fish eye lens on the GoPro camera shows a concave earth. The fish eye lens will show the earth's horizon either concave or convex, depending on the camera's orientation to the horizon. In the picture below the earth is at the outer circumference of the fish eye lens, causing the flat horizon to appear concave. In the picture above, however, the sky is at the outer circumference of the fish eye lens, thus causing the earth's flat horizon to appear convex. In fact, the earth's horizon is neither convex nor concave, it is flat.



Below is a picture taken from a camera aboard a seized German V-2 rocket launched from the White Sands Missile Range in New Mexico, on October 24, 1946.¹²⁷ The photograph was taken from a reported altitude of 65 miles (343,200 feet). The picture from the upper atmosphere is hailed as the first photograph ever taken of the earth from what scientists call “space.” Today, pilots exceeding 50 miles in altitude are considered to have entered “space” and are awarded astronaut wings. The World Air Sports Federation (Fédération Aéronautique Internationale) has decreed that a pilot exceeding 100 kilometers (62.1 miles) in altitude is considered to have gone into “space.” It seems that “space” occurs at arbitrary altitudes, in nice round numbers; in the U.S. it’s 50 miles, in Europe it’s 100 kilometers. That doesn’t seem very scientific.

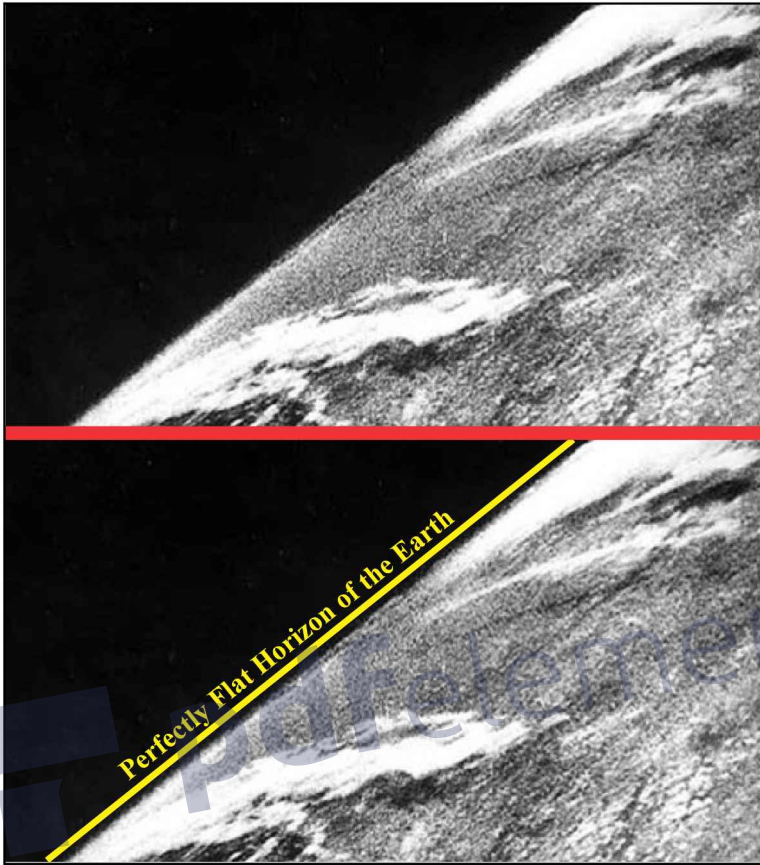
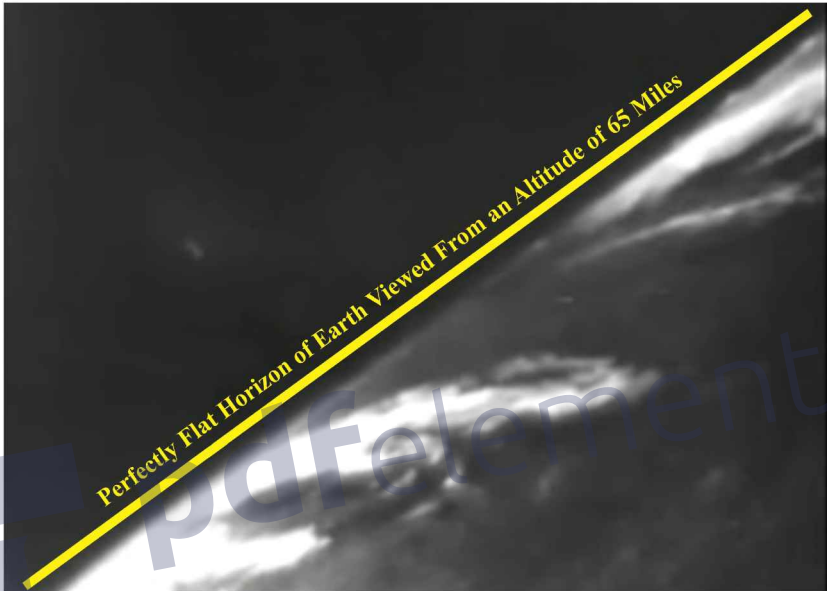

Figure 60: First Photograph taken from what scientists call “space,” at an altitude of 65 miles (343,200 feet), on October 24, 1946.

The picture taken from the unmanned V-2 rocket was taken almost three times the distance in altitude from which Baumgartner jumped. Notice that the earth’s horizon is perfectly flat. One would think that if the earth were a globe, the curvature of that globe would be more pronounced the higher in the sky from which the earth is viewed. Again, this is evidence that the Baumgartner photograph, supposedly showing the curvature of the earth, is in fact distorted by the fish eye lens on the Go-Pro camera

used to take the picture. The earth is in fact a flat plane.

Below is a screenshot from a video taken from a camera aboard the V-2 launched on October 24, 1946. It shows a little bit longer view of the horizon. The published picture above, was cropped to show a shorter horizon than is depicted in the video.



NASA has cropped the originally published photo of the horizon even further in its version of the V-2 high altitude picture posted on its website.¹²⁸

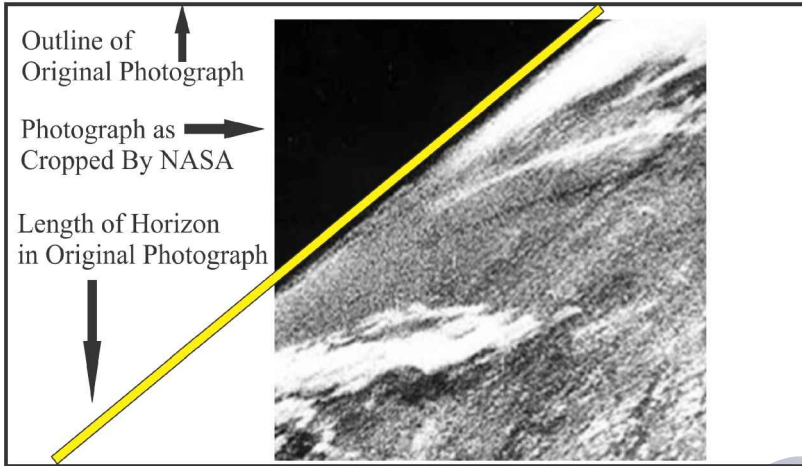

NASA displayed the cropped photo behind a circular frame on its website, which provided additional cropping of the horizon. The circular frame was used by NASA, presumably to suggest to the viewer a spherical earth.

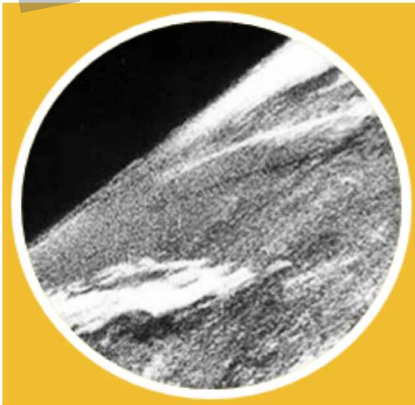

Figure 63: Horizon from V-2 photograph as it appeared on the NASA website

The NASA website shows a very limited, double-cropped view of the photograph that was originally published as the first photograph from space. There seems to be an effort by the government to conceal the flat horizon. One would think that NASA would want to present the most expansive view of the earth possible. Yet, NASA

does just the opposite. There is no rational explanation for cropping an already small grainy photograph of earth from the upper atmosphere, other than to conceal from the public the flat horizon of the earth depicted in that photograph.

Below is yet another screenshot taken of a video from an altitude of approximately 65 miles (343,200 feet) above the earth using a camera aboard a separate V-2 rocket launched from the White Sands Missile Range in the late 1940's.¹²⁹ It shows yet a longer view of the perfectly flat horizon of the earth.



Below is a frame from a video taken in the 1960s at a reported altitude of 317,000 feet (60 miles) from a camera aboard

an X-15 hypersonic experimental aircraft in the 1960s. Note the flat horizon.

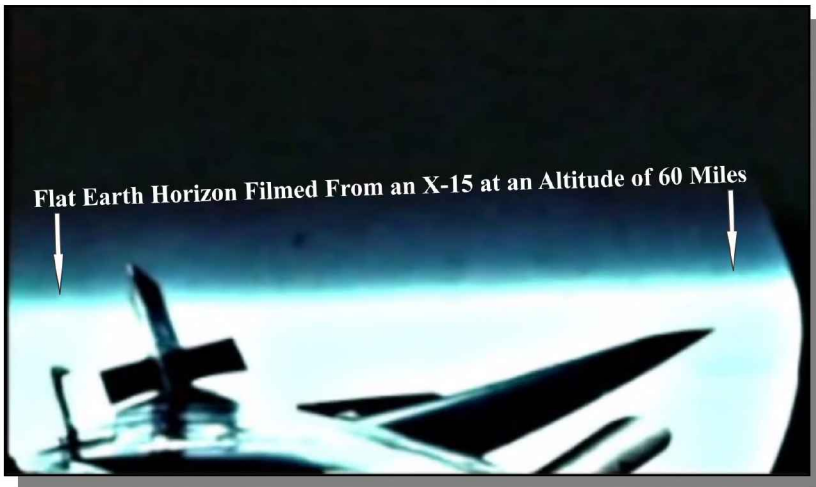

Below is a picture taken from a camera attached to a balloon floating at approximately 80,000 feet in altitude. Notice the flat, eye level horizon. Notice also, the hot spot on the clouds cast from the sun. The only way that the sun could cast a hot spot on the clouds would be if the sun was in fact directly over the surface of the earth. It is impossible for a sun that is 93 million miles away, as alleged by heliocentric scientists, to cast a hot spot on the clouds, as is revealed in the photograph.

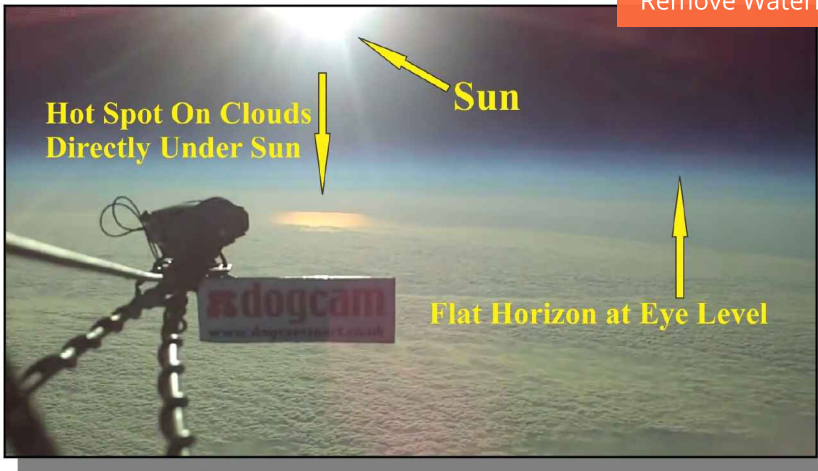

Figure 66: Flat horizon at eye level from an altitude of 80,000 feet. Note the hot spot on the clouds directly under the sun, which indicates that the sun is much smaller than the earth and close overhead.

pdfelement

10

No Coriolis Effect Proves a Stationary Earth

One principle of movement on a spinning globe, is that the spinning will necessarily produce what is known as a Coriolis effect. The Coriolis effect was first postulated by Gustave-Gaspard Coriolis, a French engineer, mathematician, and physicist who was born on May 21, 1792 and died on Sept. 19, 1843. The *Encyclopedia Britannica* states that the Coriolis force is “an effect of motion on a rotating body, of paramount importance to meteorology, ballistics, and oceanography.”¹³¹

The *Encyclopedia Britannica* further explains the Coriolis force as it pertains to the supposedly spinning spherical earth:

In 1835 he [Coriolis] published a paper, “Sur les équations du mouvement relatif des systèmes de corps” (“On the Equations of Relative Motion of Systems of Bodies”), in which he showed that on a rotating surface, in addition to the ordinary effects of motion of a body, there is an inertial force acting on the body at right angles to its direction of motion. This force results in a curved path for a body that would otherwise travel in a

straight line. The Coriolis force on Earth determines the general wind directions and is responsible for the rotation of hurricanes and tornadoes.¹³²

The Encyclopedia Britannica provided a graphic to explain the Coriolis force on the supposedly spinning globular earth. The graphic is reproduced below.

The effect of the Coriolis force

Nonrotating Earth

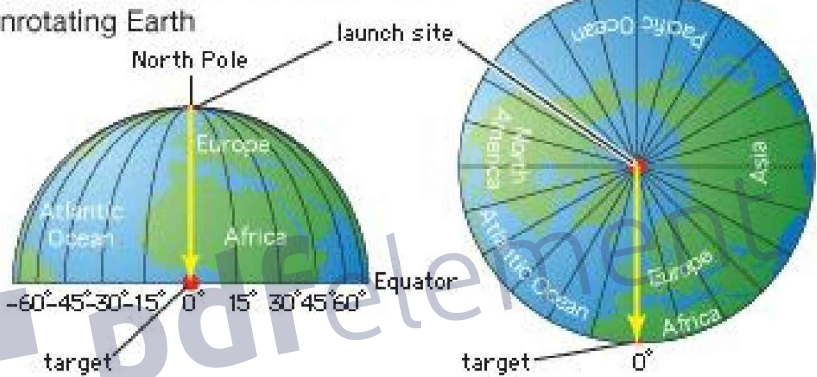

Earth rotating 15° each hour

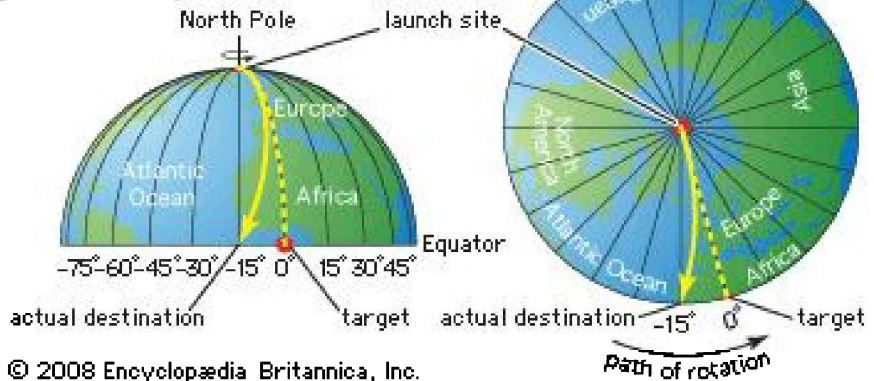

© 2008 Encyclopædia Britannica, Inc.

The problem with the above illustration from the Encyclopedia Britannica, is that it has no basis in fact. The Coriolis Force is very real. If the earth were in fact a spinning globe, the Coriolis effect would be manifested. The problem is that there is no such Coriolis effect taking place on earth. Which means that the earth is not spinning. The different directions of rotation of hurricanes in northern and southern latitudes has nothing to do with the claimed Coriolis effect of the spinning earth.

Planes that fly north and south do not adjust their flight paths to account for any Coriolis effect. For example, assuming the heliocentric model with the earth traveling at more than 1,000 mph at the equator, the Coriolis effect would cause a plane flying from Buffalo, New York to Miami, Florida to fly off course in a westerly direction due to the supposed faster spin of the earth as the plane approaches the wider circumference of the earth at the latitude of Miami, Florida. Yet, in reality, the flight arrives in Miami on time and without the pilot having to adjust for any Coriolis effect due to the rotation of the earth.

Indeed, if there was a Coriolis effect it would be nearly impossible to land a plane on a runway. A runway that runs north and south would be careening at approximately 1,000 miles per hour across the path of the plane, which would make it impossible to line up the plane for a landing.

The Coriolis effect for spinning objects is real. Modern scientists must sell the myth that there is a Coriolis effect manifested on the earth, in order to make the spinning earth seem real. The fact that there is no Coriolis effect on the earth, creates a real problem for “scientists.” Their solution to that little problem is to lie. They claim that there is a Coriolis effect, when there is not. The following from the National Geographic is an example of the modern explanation of the Coriolis effect that is supposed to

be manifested on earth, but is, in fact, completely absent.

Let's pretend you're standing at the Equator and you want to throw a ball to your friend in the middle of North America. If you throw the ball in a straight line, it will appear to land to the right of your friend because he's moving slower and has not caught up.

Now let's pretend you're standing at the North Pole. When you throw the ball to your friend, it will again appear to land to the right of him. But this time, it's because he's moving faster than you are and has moved ahead of the ball.

This apparent deflection is the Coriolis effect. ...

Fast-moving objects such as airplanes and rockets are influenced by the Coriolis effect. Pilots must take the Earth's rotation into account when charting flights over long distances. This means most planes are not flown in straight lines, even if the airports are directly across the continent from each other. The line between Portland, Maine, and Portland, Oregon, for instance, is very long, and fairly straight. However, a plane flying from Portland, Oregon, could not fly in a straight line and land in Portland, Maine. Flying east, the Coriolis effect seems to bend to the right, in a southerly direction. If the Oregon pilot flew in a straight line, the plane would end up near New York or Pennsylvania.

Military aircraft and missile-control technology must calculate the Coriolis effect for similar reasons. The target of an air raid could be missed

entirely, and innocent people and civilian structures could be damaged. ...

The Coriolis force applies to movement on rotating objects. It is determined by the mass of the object and the object's rate of rotation. The Coriolis force is perpendicular to the object's axis. The Earth spins on its axis from west to east. The Coriolis force, therefore, acts in a north-south direction. The Coriolis force is zero at the Equator.

Though the Coriolis force is useful in mathematical equations, there is actually no physical force involved. Instead, it is just the ground moving at a different speed than an object in the air.¹³³

The National Geographic is just one of many examples of a massive deception. The earth is supposed to be spinning at approximately 1,000 miles per hour at the equator. Because the circumference of a ball is smaller north and south of the equator, the earth does not spin at as great a speed at higher and lower latitudes. Portland, Oregon, is at 45 degrees north latitude from the equator and the purported spin of the earth at that latitude is approximately 700 miles per hour. Portland, Maine is at 44 degrees North latitude with the spin of the earth only a tiny bit faster than 700 miles per hour. The Coriolis effect is supposed to put the plane in New York if the pilot simply tried to fly the plane straight and level toward Portland, Maine. That is simply not true. The pilot sets his heading toward Portland, Maine and accounts only for wind conditions. The pilot makes no accommodation whatsoever for a Coriolis effect, because the earth is not spinning; there is no Coriolis effect to calculate.

The national Geographic alleges that “military aircraft and

missile-control technology must calculate the Coriolis effect. The National Geographic cites to no authority for its statement, for the simple reason that no authority exists. No authority exists because it is not true. The National Geographic is simply making things up to fool the gullible public into believing that the earth is spinning at an incredible speed.

The theory of the Coriolis effect in the National Geographic example is that the eastbound plane would be able to keep up with the speed of the allegedly spinning earth, because the plane at take-off would be adding its speed to the 700 mph speed of the runway in Portland, Oregon. The problem with that argument is that it assumes that the runway is lined up due-east, and the plane is taking off from the runway in a due-east direction.

The Coriolis effect is supposed to be based upon the spin of the earth and the fact that objects in motion over the spinning earth are moving independent of the spin of the earth once they are in motion. If there truly were a Coriolis effect on earth, it would pose a real problem for plane flights. If a plane were to take off from an airport in Portland, Oregon, in a North/South runway and turned east to fly to Portland, Maine, the plane would never make it to Portland, Maine. That is because, the plane would be traveling at approximately 560 miles per hour once it reached cruising altitude. The earth, however, would be spinning at 700 miles per hour eastbound beneath the plane. The plane would never be able to catch up with the speed of the earth's spin. The plane would be constantly losing distance over the ground at the rate of 140 miles per hour. Essentially the plane would be moving backwards over the ground.

What is found is exactly the opposite. A plane traveling eastbound from Portland, Oregon, to Portland, Maine, would in fact have a shorter flight time than a plane traveling westbound from Portland, Maine, to Portland, Oregon. The reason has nothing to do with the spin of the earth. The high velocity

eastbound winds at high altitude, known as the jetstream, carry the planes along and allow eastbound flights to have a faster ground speed. The jetstream can have wind speeds ranging from 60 miles per hour to over 250 miles per hour. That same jetstream is a hindrance to westbound flights. It was reported in January, 2015, that a British Airways Boeing 777-200 Jet was able to travel at ground speeds in excess of 745 miles per hour as it traveled in the eastbound jetstream of approximately 250 miles per hour.¹³⁴ Incidentally, the speed of sound is 760 miles per hour at sea level.

David Wardlaw Scott explains experiments done in England at the turn of the 20th century, using a cannon, which showed that there was no Coriolis effect whatsoever manifested on earth, thus indicating that the earth is motionless. In the experiments, a cannon was fixed firmly on the ground in a precisely vertical position. The cannon was fired. The cannon ball ascended for 14 seconds vertically and it took 14 seconds for the cannon ball to fall back to earth, for a total of 28 second aloft. If the earth were traveling eastward at 600 miles per hour at the latitude in England, the cannon ball would be expected to land almost 5 miles to the west of the cannon. However, that did not happen. The cannon ball fell generally within 2 feet of the cannon. In a couple of instances, the cannon ball actually returned to the cannon's mouth.¹³⁵



Figure 68: Cannon shot vertically and returning to ground near cannon, proving no Coriolis force on Earth.

If there were any spin to the earth causing a Coriolis effect, it would have been discovered by now. Yet every single experiment ever performed to detect the motion of the earth has returned a null result (e.g., the Michelson/Morley experiment). Real-life experiments have proven that there is no Coriolis effect on Earth, because the earth is stationary. Governmental educational systems, however, persist in pushing the myth of a Coriolis effect on a supposedly spinning Earth. Indeed, they must argue that there is a Coriolis effect, because if they let it be known that there is no Coriolis effect, that would let the cat out of the bag that the earth is stationary. For example, below is an illustration from the Coastal Practice Network, which is funded by the European Union Regional Development Fund.¹³⁶

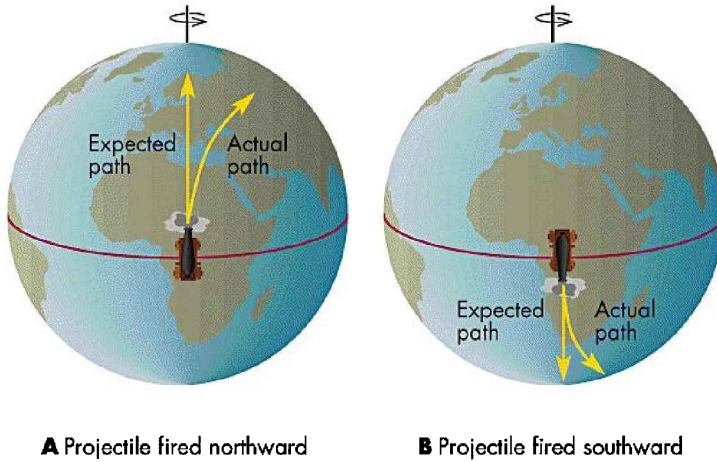

Figure 69: Coastal Practice Network showing their depiction of Coriolis effect of a cannon shot on Earth due to spin of earth. However, No such effect actually happens, because the earth is not a globe and does not spin.

Indeed, if there were truly a Coriolis effect on earth as depicted in the above illustration, then the artillery officers and snipers would be trained to consider the spin of the earth in making their calculations for accurate firing. Yet, you will look in vain for any mention of Coriolis effect in any military artillery¹³⁷ or sniper instruction manual.¹³⁸ In all of the wars fought throughout history, no soldier has ever been instructed to consider the Coriolis effect of a spinning Earth when citing in a target with his artillery piece or other weapon.¹³⁹ The folly of adjusting for a mythical Coriolis effect would be immediately apparent, as the soldier's round would travel off course and miss the target.

This author is a former federal firearms instructor. I have seen many thousands of rounds shot from all kinds of firearms at

various distances. I have never witnessed any rounds fired ever be affected by the alleged Coriolis effect. I have never read the Coriolis effect discussed in any firearms manual; nor have I ever heard it be discussed by any firearms instructor as something to consider in the use of any firearm, from any distance.

If, in the real world, those whose lives depend on the accuracy of their performance using weapons do not consider the Coriolis effect, that is convincing evidence that there is no Coriolis effect on earth. That means that the earth is not spinning. All of the pretty colored diagrams showing a spinning earth with cannon balls going off-course due to the supposed Coriolis effect depict an unreal myth. The earth is fixed and does not move.

 pdfelement

11

Emergency Landing Evidence of a Flat Earth

On October 7, 2015, a Chinese Airlines (CAL) flight made an emergency landing at Ted Stevens Anchorage Airport in Alaska.¹⁴⁰ The emergency landing was necessary, because a woman had gone into labor and subsequently gave birth during the flight. The flight originated from the Taiwan Taoyuan International Airport and was scheduled to land in Los Angeles, California. The pilot decided to divert the flight to Anchorage Airport, six hours after taking off, after he was informed that the woman's water broke.

Below is a map, using the standard Mercator projection of the earth, which assumes that the earth is a globe. The Mercator projection has become the standard map to depict the globular earth. It is the projection used by Google Maps. The map below depicts the supposed route from Taiwan to Los Angeles, with a dotted line showing the emergency diversion route to Anchorage, Alaska, on a globular earth. The emergency landing in Anchorage, Alaska, makes little sense if the earth were a globe, because the flight diversion means that the airline decided to divert a flight from its scheduled destination of Los Angeles, which is a city of almost 4 million people that offers some of the best medical care in the world, to a far-off city less than one-tenth its size, in a

wilderness state, and saving very little time in the process. If the earth were a globe, the only logical diversion of the flight would be to Hawaii. If the earth were a globe, it would appear that the pilot made an irrational decision to divert the flight to Anchorage, which the Mercator projection of the spherical earth depicts as approximately three times further away than Hawaii at the point he made the decision to divert the flight.

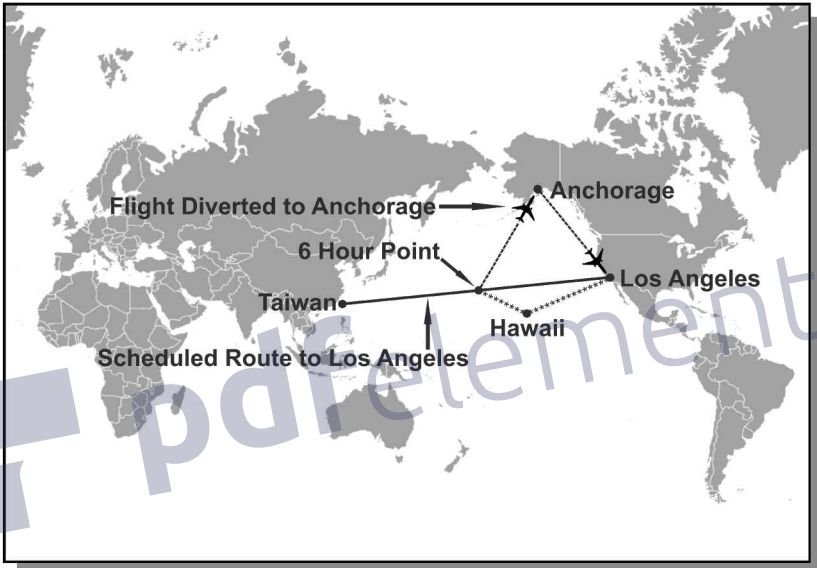

Figure 70: Flight path of the CAL emergency landing in Anchorage if the earth were a globe.

According to CAL, the “flight took off from Taiwan Taoyuan International Airport at 11:50 p.m. Wednesday and was scheduled to arrive in the U.S. at 8:35 p.m., Wednesday, Los Angeles time [12:35 p.m., Thursday, Taipei time].”¹⁴¹ Due to the flight diversion, the plane landed at Anchorage at 9:06 a.m. Thursday (Taipei time).¹⁴² That means that the diversion to Anchorage, Alaska, caused the plane to land in Anchorage 3 hours and 29 minutes earlier than the scheduled arrival time in Los

Angeles. That 3 hour and 29 minute difference would be impossible if the earth were a globe, because on a globe, the distance to Anchorage is supposed to be only a little less than the distance to Los Angeles at the point of diversion, not a full 3 hours and 29 minutes.

The anomaly of the diverted plane arriving in Anchorage 3 hours and 29 minutes ahead of its scheduled arrival time in Los Angeles is explained by the fact that the earth is not a globe. Below is a graphic that shows the reality of the flat earth and perfectly explains the decision to divert the flight to Anchorage, Alaska. It illustrates why the pilot did not divert the flight to Hawaii and how the flight arrived in Anchorage 3 hours and 29 minutes before the scheduled arrival time in Los Angeles. Assuming the typical cruising speed for an airliner of 560 miles per hour, that plane would be expected to travel from the airspace over Anchorage, Alaska, to Los Angeles, California, a little over 2,300 miles away, in approximately 4 hours. That seems to explain the 3 hour and 29 minute early arrival in Anchorage.

On the actual flat earth, Anchorage is a destination that is almost directly along a straight flight path from Taiwan to Los Angeles. On that flight path, Anchorage is more than 2,300 miles northwest of Los Angeles, making it the logical place for an emergency landing. That is the reason the pilot chose to stop in Anchorage, rather than continue to fly to Los Angeles. As you can see in the polar azimuthal equidistant flat earth map below, the diversion of the flight to Anchorage, Alaska, makes perfect sense on the flat earth. The flat earth map shows that Anchorage is on the way to Los Angeles from Taiwan and therefore was the logical place to stop to see that the woman received medical attention.



Figure 71: Flight path of the CAL emergency landing in Anchorage as it actually happened on the flat earth.

If the earth were a globe, it would have made more sense to divert the flight to Hawaii, which would be much closer than Anchorage. The flat earth map illustrates why the pilot did not divert the flight to Hawaii. In reality, flying to Hawaii would take the plane on a course that would be thousands of miles out of the way and create many hours of delay. The fact that the pilot diverted his Los Angeles bound flight to Anchorage is evidence that Anchorage was along the flight route from Taiwan to Los Angeles on a flat earth.

If the earth were a globe, the pilot never would have

chosen to divert the flight to Anchorage, since the flight distance to Los Angeles appears only slightly longer on a globe. The logical place to divert the flight on a globe would be Hawaii. However, the pilot did not do that, thus indicating that the earth is flat. On a flat earth it only made sense to divert the flight, as the pilot did, from Los Angeles and stop on the way at Anchorage, Alaska. The pilot made the rational decision to land in Anchorage, because Anchorage was along the actual flight route on a flat earth. The emergency landing at Anchorage reveals the reality that the earth is flat.

There are other emergency landings of aircraft that confirm that the earth is flat. For instance, on February 3, 2017, USA Today reported that “[p]assengers bound for sunny Southern California made an unexpected visit to Canada's Arctic region Wednesday when their Swiss International Air Lines Boeing 777 made an emergency landing in tiny Iqaluit.”¹⁴³ Swiss International Air “Flight 40 was headed from Zurich to Los Angeles, flying near Canada’s far north when it suffered a problem to one of its engines and diverted to Iqaluit.”¹⁴⁴ Iqaluit airport director John Hawkins told the National Post of Toronto that the real issue was they only had one engine.”¹⁴⁵

Looking at a projection map of the spherical earth, it seems to make no sense for the pilot to fly to the far north of Canada to a small town with a population of 7,000 people to make an emergency landing. Iqaluit is so remote and isolated that it has no road or rail connections to the rest of Canada. Ship connections are completely cut off for part of the year due to the winter cold which renders ship passage impossible. Indeed, it is so cold that Airbus uses the Iqaluit Airport for cold weather testing of its aircraft.

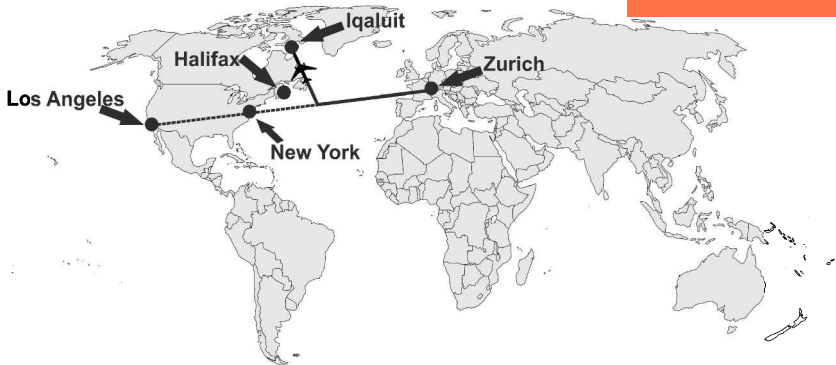

Figure 72: Flight path of the Swiss International Airlines emergency landing in Iqaluit if the earth were a globe.

Why would any pilot risk flying out of his way to Iqaluit on one engine? Iqaluit is so remote and cold it is used to test the limits of aircraft operation in cold weather. The emergency landing was in mid-winter. Indeed, the temperature at the time the plane landed in Iqaluit was -6°F (-21°C) and later dropped to -20°F (-29°C). Why risk a failure of the only remaining engine that would be operating close to its cold weather limit? The pilot would only pick Iqaluit to make an emergency landing if it had the closest airport. But Iqaluit does not appear to be the closest airport on the map of the spherical earth.

The spherical earth map indicates that landing at Iqaluit was irrational. When one looks at the flight path on the projection of the spherical earth on the map below, it appears that the pilot passed by much closer international airports in Halifax and New York. Those large international airports are in cities that have milder temperatures and are much better equipped to both service the jet and provide alternative flights to the passengers traveling to Los Angeles.

Clearly something is amiss here. That something is that the earth is not a sphere and the projection of the spherical earth on

the map above is not accurate. Indeed, the news article let the cat out of the bag by explaining that the Swiss airliner suffered engine failure when it was “flying near Canada’s far north.” Notice in the spherical earth map above that at no time prior to the flight’s diversion was the airplane “near Canada’s far north.” Indeed, on a spherical earth, the plane flying from Zurich to Los Angeles would never come near, let alone fly over, Canadian airspace.

But when we look at the polar equidistant azimuthal flat earth map we find that in fact the plane’s flight path from Zurich to Los Angeles takes it directly over “Canada’s far north.” Iqaluit is directly in the path of the flight. The statement about nearing Canada’s far north also gives us a clue that the engine trouble started as the aircraft was “near” the Canadian coast. That indicates that the aircraft had already crossed the ocean and was near Canadian airspace when the engine failed. That could only have happened on a flat earth.

 pdfelement

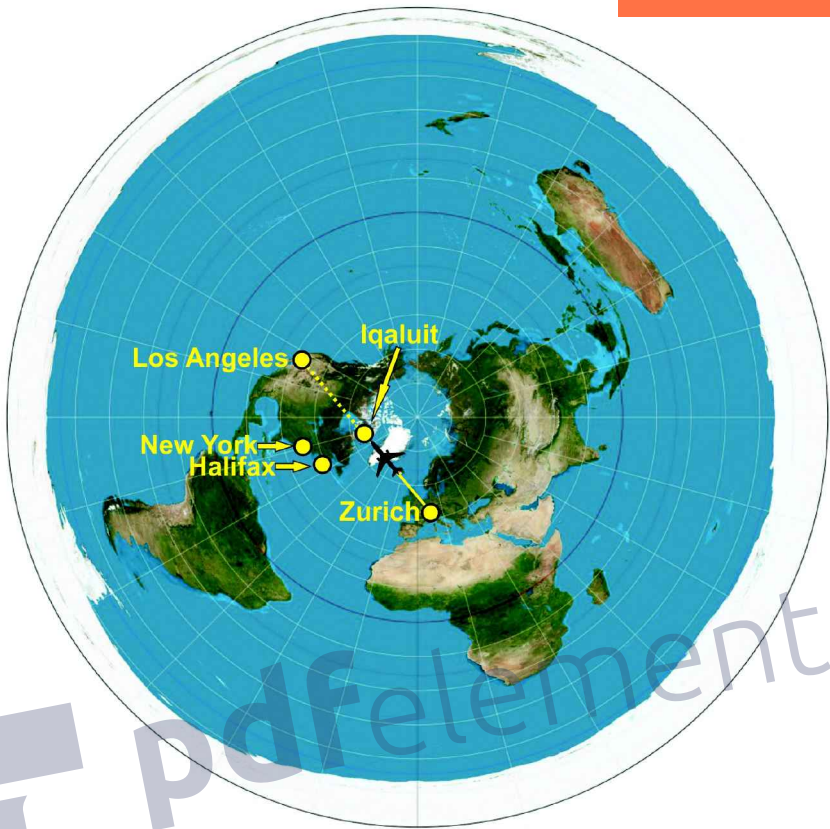

Figure 73: Flight path of the Swiss International Airlines emergency landing in Iqaluit as it actually happened on the flat earth.

Notice on the flat earth map that both New York and Halifax would take the plane on a long detour and thus dangerously extend the time the plane struggled to stay aloft with only one engine. It made perfect sense on a flat earth for the pilot to make an emergency landing at the remote airstrip at Iqaluit. That emergency landing of the Swiss International Air Lines Boeing 777 is yet more proof that the earth is flat.

Indeed, there are many more emergency landings that reveal evidence of a flat earth. For example, TASS Russian News

Agency reported that “an Emirates passenger plane en route from San Francisco to Dubai made an emergency landing at Moscow’s Domodedovo airport after one of its passengers felt sick.”¹⁴⁶

When one looks at the flight route on a projection map of the spherical earth it seems that the pilot made a very strange decision to divert the flight to Moscow. The spherical earth projection map makes it appear that the pilot passed over Madrid International Airport and all of the other international airports in Western Europe in order to fly all the way to Moscow to make an emergency landing. Madrid International Airport is not a backwoods airport. It is the sixth largest airport in Europe and services more than 50 million passengers per year.



Figure 74: Flight path of the Emirates Airline emergency landing in Moscow if the earth were a globe.

An emergency landing, by definition, means that the pilot must get the plane on the ground quickly. That requires that he get to the nearest airport, not the furthest airport. It would make no sense for the pilot to pass over Madrid International Airport and all of the other international airports in Western Europe in order to make an emergency landing in Moscow.

When, however, we look at the flight on a polar azimuthal

equidistant projection of the flat earth we find that the pilot made a rational decision to go to the nearest airport, which was at Moscow. The standard projections of the spherical earth have pilots making emergency landings appear to be insane clowns who are passing over nearby airports in order to fly way out their way to make emergency landings. The pilots are in fact highly trained and competent pilots who are making rational decisions in emergencies to fly to the nearest airport on a flat earth.

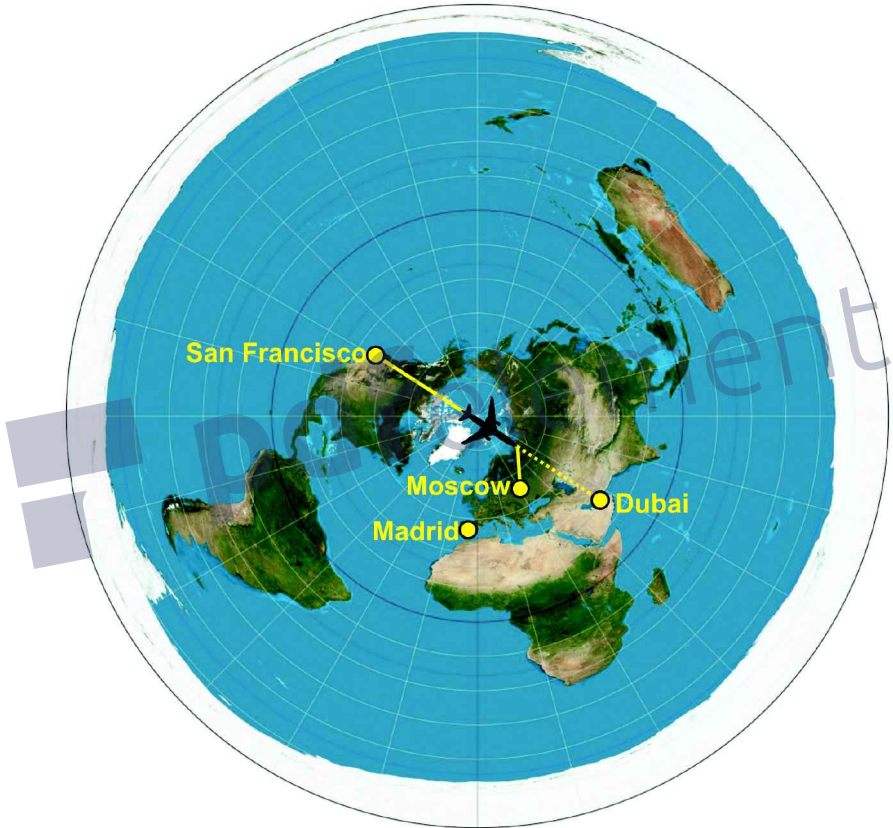

Figure 75: Flight path of the Emirates Airline emergency landing in Moscow as it actually happened on the flat earth.

There are many other instances of emergency landings that prove the earth is flat.¹⁴⁷ For example, The Daily Express reported on April 7, 2016 that “[a] Boeing 777-300 plane flying from Doha,

Qatar to Chicago made an emergency landing today at Domodedovo airport in Moscow after a 14-year-old fell ill.”¹⁴⁸ That is a similar situation to the above illustrated San Francisco to Dubai flight. Making an emergency landing in Moscow in a flight from Doha to Chicago makes no sense on a spherical earth. But when one looks at the flight path on the flat earth, it makes perfect sense, thus proving the earth is flat.

Another notable example is the report by USA Today on July 31, 2015, that “Cathay Pacific said Thursday that after a preliminary inspection it appears that it was smoke from a malfunctioning cooling fan that caused the captain of Flight CX884, on route from Hong Kong to Los Angeles, to make a precautionary diversion to a remote military airport near the Aleutian Islands in Alaska on Wednesday.”¹⁴⁹ That is similar to the October 7, 2015, Chinese Airlines (CAL) flight illustrated above. Making an emergency landing in a remote military air strip in the Aleutian Islands makes no sense on a spherical earth. But when one looks at the flight path on the flat earth, it makes perfect sense. The emergency landings of those flights is compelling evidence that the earth is flat.

12

Simple Proof That Heliocentrism is Impossible

For most people it is a new concept to think that the sun might be much smaller than the earth and confined to the space directly above the plane of the earth. Before discussing the scientific proof for that, let us examine the standard theory of the heliocentric model. Under the heliocentric theory, the earth orbits the sun once every 365.25 days. Since we only have a 365 day calendar, every four years ($4 \times .25 = 1$ day) we have a leap year and add a 29th day to February to make up that one missing day. In those 365.25 days, the earth is supposed to orbit a full 360 degrees around the sun. At the same time the earth is orbiting the sun, it is completing one 360° rotation every 24 hours.

Under the heliocentric model, as the earth travels around the sun, each day the earth will be a little less than one degree further in its orbit from the previous day. That means that every 6 months the earth will be 180 degrees in its orbit around the sun and be opposite the sun from where it was 6 months earlier. There is a problem with this model. Let us assume that we begin our observation of the sun at 12:00 noon in New York on September 22nd. Each solar day is precisely 24 hours in length. According to the heliocentric model, every 24 hour day, the earth is supposed to do an exact 360 degree spin on its axis and end up at the same

place. At the same time, each day the earth has traveled a little less than one degree of the 360° orbit around the sun. That means that after 6 months, 12:00 noon in New York will arrive during the middle of the dark night on March 21st.



To recap, 12:00 noon arrives in the middle of the day in New York on our start day on September 22nd. The heliocentric theory requires the earth to be at the opposite side of the sun 6 months later. Consequently, New York will be on the dark side of the earth facing away from the sun at 12:00 noon on March 21st. In New York, therefore, on March 21st, 12:00 noon should arrive during the middle of the night. Under the heliocentric model, this occurrence should happen year-in and year-out, every year. We know, however, that does not happen, which means that the heliocentric model is wrong.

According to our 365 day calendar, we need a leap year once every 4 years to make up for a missing day. That means that after 6 months, the earth is supposed to have missed 1/8th of its orbit around the sun. However, that does not change the fact that under the heliocentric model, 12:00 noon in New York will

progressively move a little less than one degree each day until it arrives during the middle of the dark night opposite the sun after 6 months. That is because each solar day is precisely 24 hours in length, which under the heliocentric model requires the earth to rotate exactly 360° on its axis in those 24 hours.

The high priests of heliocentricity have perceived the problem with their model and adjusted it to accommodate its error. What did they do? They added $.986^\circ$ to the 360° rotation of the earth, to come up with the earth spinning 360.986° each day.¹⁵⁰ Where did they get the $.986^\circ$? They simply made it up by dividing the 360° of orbit by 365.25 days in the year, to come up with $.986^\circ$. With this little mathematical adjustment, their problem is seemingly solved. Because they claim the earth rotates 360.986° in 24 hours, they calculated that the period of time for the earth to rotate 360° is 23 hours, 56 minutes, 4.1 seconds.¹⁵¹ They call this shorter day, a sidereal day. A sidereal day is supposed to be based upon the length of time which passes between the position of the stars in the night sky. A sidereal day is irrelevant to the movement of the sun.

Below is a diagram from Cornell University Department of Astronomy illustrating the contrived 360.986° rotation each day.¹⁵²

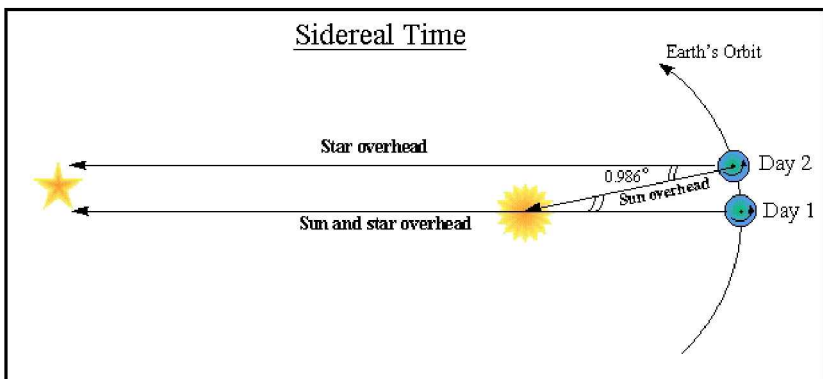

The first problem with the 360.986° solution is that it is contrary to the orthodoxy of the heliocentric model, which presents a precise 360° rotation of the earth every 24 hour solar day. The reason that the standard heliocentric model requires a 360° rotation in 24 hours is that it comports with the actual movement of the sun over the earth. The 360° path of the sun over the earth every 24 hours is observable and measurable.

The Annenberg Foundation's teacher resource center, which is affiliated with Colorado State University, has a model of the globular spinning earth and explains that "[e]ach day, the earth rotates once on its axis, which equals 360 degrees."¹⁵³ The University of California at Berkeley's online self study guide states that the earth spins 360 degrees every 24 hours, "Full turn = 360 degrees."¹⁵⁴ The University of Chicago Department of Astronomy and Astrophysics states that the earth rotates 360° "once every 24 hours."¹⁵⁵

Professor of Astronomy Courtney Seligman, who has taught college astronomy for 39 years, states that "[t]o calculate how long it takes for the Earth to rotate through an angle of one degree, we divide the length of a day, 24 hours or 1440 minutes, by the 360 degrees it turns through during that rotation, obtaining a rotational speed of 4 minutes per degree."¹⁵⁶

Professor Seligman created a diagram of the movement of the earth around the sun. He gave the following explanation of he diagram:

In the diagram below the four blue dots on the right represent the position of the planet at four times, separated from each other by a third of a rotation period. The number of rotations that the planet has made is indicated by the numbers to the right of each dot. The white dot shows how the position of a specific place on the planet

changes as the planet rotates to the east (counter-clockwise in this diagram), and the large yellow dot on the far left represents the position of the Sun. The sizes of the Sun and planet and the angle that the planet moves through during one rotation have been exaggerated to make it easier to see what is happening. The movement of a planet during one rotation. The planet's movement around the Sun causes the Sun to appear to move around the sky. Each degree that the planet moves around the Sun causes the Sun to appear to move a degree around the planet.¹⁵⁷



Figure 78: Diagram by Professor Seligman explaining the supposed 360° rotation of the earth as it orbits the sun.

Professor Seligman illustrates the standard model of heliocentricity with the movement of the earth around the sun as it rotates on its axis 360° each 24 hour day. His diagram confirms this author's diagram presented at the beginning of the chapter as the standard heliocentric construct. The depiction of the heliocentric orbit of the earth at the beginning of this chapter was from Penn State University John A. Dutton e-Education Institute, and it is the standard heliocentric model accepted by virtually all scientists today.¹⁵⁸ The diagram was annotated by this author with the captions pointing out where 12:00 noon in New York would be at each quarter of the earth's yearly orbit. Other than the annotations, the diagram appears as Penn State depicted it.

Professor Seligman has taught college astronomy for 39

years and has a full and complete understanding of heliocentrism. His diagram illustrates that the heliocentric model does not comport with reality. If Professor Seligman's diagram was expanded to encompass a 180° travel of the earth around the sun, we would find that 12:00 noon would arrive in the middle of the night after 6 month's time, just as depicted in the diagram at the beginning of this chapter. We know that in fact every day 12:00 noon arrives in the middle of the day in New York. There has never been a day in history of New York ever when 12:00 noon was in the dark of the night. That simple fact proves that the heliocentric model is wrong.

Professor Seligman, and the many astronomers like him, are wrong that the earth orbits the sun. They are correct, however, about the relationship between the sun and the earth being one of 360° and 24 hours. The sun in fact does make a 360° circuit over the flat earth once every 24 hours.

The contrivance of other astronomers of the earth spinning 360.986° every 24 hours is provably wrong. It is refuted by the fact that the sun can be measured to move in a 360° path over the earth every 24 hours. All celestial navigation is based upon that truth. Celestial navigation is based upon the confirmable fact that the sun moves 15° each hour ($360^\circ \div 24 \text{ hours} = 15^\circ$). Each hour can in turn be broken down to minutes per degrees by simply taking $60 \text{ minutes} \div 15^\circ = 4 \text{ minutes per degree}$.

James I. Sammons explains the basic concepts of celestial navigation. As with most people, he has been conditioned to believe that it is a rotating earth that causes the movement of the sun in its path. However, he is absolutely correct about the sun and the earth having a relationship of 360° in 24 hours. Indeed, that is the basic starting point for all celestial navigation.

Just as we saw in finding Latitude, finding longitude is easy enough when we've learned

three basic ideas. The first of these ideas is the relationship between time and the rotation of the Earth. It takes an average time of 24 hours for the Earth to rotate 360 degrees so that a spot on its surface will move from under the Sun and then just return to it's under-the-Sun starting position. In 12 hours, the Earth will turn half around. In 6 hours, a quarter. If you divide the number degrees in a circle by the number of hours in a day, we find that the Earth turns 15 degrees each hour. $360^\circ \div 24 \text{ hours} = 15^\circ \text{ per hour}$. We can take this a step further and state that the Earth turns one degree in four minutes. $1 \text{ hour} = 60 \text{ minutes} \div 15^\circ = 4 \text{ minutes per degree}$.¹⁵⁹

Mariners have been using celestial navigation for hundreds of years to mark an accurate course. It is based upon the 360° movement of the sun over the earth in 24 hours. Of course modern mariners have been conditioned to believe that it is the globular earth that is spinning. Mariners, however, have often found that their charts based upon a globular earth were inaccurate (particularly in the southern latitudes) when they compared their dead reckoning using their charts with their more accurate celestial navigation. The fact that celestial navigation is based upon the sun's movement of 360° in 24 hours, and that it actually works, impeaches the sidereal day construct that postulates a 360.986° spin of the earth in 24 hours.

Sidereal literally means "relating to, or expressed in relation to stars or constellations."¹⁶⁰ A sidereal day is a measure of the movement of the stars. It is pure and simple deception to apply calculations for the movement of the stars to the movement of the sun. Never has there been celestial navigation involving the sun traveling 360.986° in 24 hours. That proves that the added $.986^\circ$ is wrong. It is a contrivance of the heliocentric priesthood. It is a superstitious belief that was conjured up in order to explain

the otherwise impossible heliocentric model. The added 1986 only has validity because the scientists say so. Their 360.986° contrivance is impeached by the observable reality that the sun travels a precise 360° circuit over the earth, once every 24 hours. That verifiable fact means that the heliocentric model would require high noon to move each day and ultimately arrive at midnight once every 6 months. The fact that such an occurrence does not happen proves the heliocentric model is a lie. Max Planck was one of the most noted scientists of the last century. He won the Nobel Prize in Physics in 1918. He revealed the cult like belief system in the scientific community. He stated that “anybody who has been seriously engaged in scientific work of any kind realizes that over the entrance to the gates of the temple of science are written the words: Ye must have faith. It is a quality which the scientist cannot dispense with.” So-called “scientists” today are more akin to witch doctors, who have mesmerized the superstitious tribe to believe their booga-booga nonsense.

 pdfelement

13

The Testimony of the Stars

Polaris proves that the heliocentric model is pure fantasy. Polaris, the North Star, is fixed above the north pole of the earth. The North Star does not move; it has never moved from its fixed position over the north pole from the fourth day of creation (Genesis 1:16) until today.

The North Star is alleged by modern scientists to be 433.8 light years away from the earth. That means that a person would have to travel at the speed of light for 433.8 years before reaching the North Star. Light travels at approximately 186,282 miles per second, which is over 670 million miles per hour.

The diagram below proves the impossibility of the heliocentric theory. If the North Star is above the North Pole, it must be moving in precise and exact synchronization with the earth. The earth is supposed to be traveling at 67,062 miles per hour around the sun in a slightly elliptical path with an average radius of over 92 million miles (approximately 1.8 billion miles in circumference).

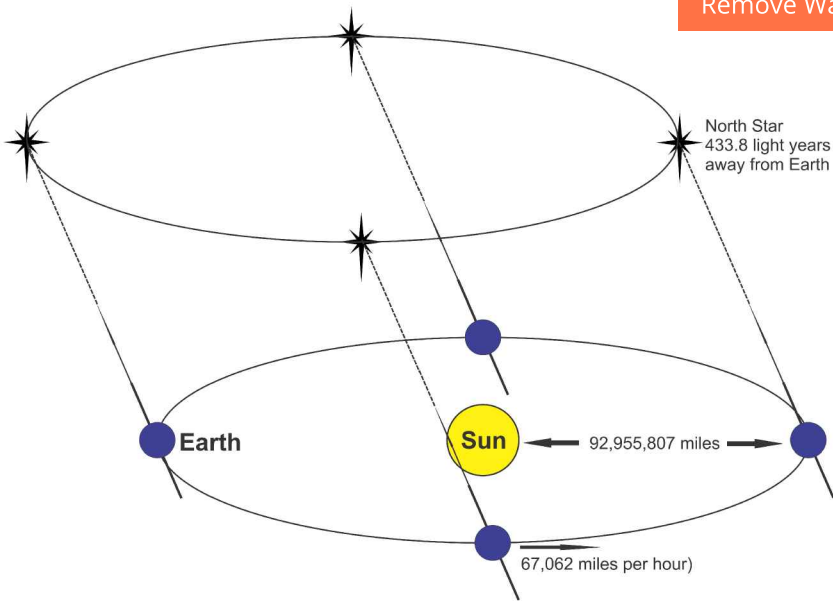

What makes the heliocentric model even more impossible is that while the North Star is supposed to be keeping itself in perfect synchronization with the orbit of the earth around the sun, the sun, itself, is supposed to be traveling at a speed of approximately 500,000 miles per hour around the Milky Way galaxy. Adding to the impossibility, the Milky Way galaxy is hypothesized by modern scientists to be racing through space at a speed ranging from 300,000 to 1,340,000 miles per hour. The heliocentric fairy tale gets even more fantastic; the perfect synchronization of the North Star with the earth finds its origin in a massive, chaotic explosion called the “big bang” that happened billions of years ago.

This insane fantasy (masquerading as science) of a spherical spinning and orbiting earth is so ingrained in the consciousness of the world, that any refutation of it is viewed by the world as itself evidence of ignorance and perhaps even insanity. Believing in a flat earth is immediately met with derision; the person is viewed as being an ignorant savage or part of a crazy

fringe cult. President Barack Obama recently tapped into that conditioned response, and used it against those who were impeding his plans for reducing the American standard of living by reducing our consumption of so-called fossil fuels. Obama stated in a speech that anyone who denied that global warming is real is an ignorant person who believes in a flat earth.

President Obama angrily blasted climate change skeptics during his energy policy speech Tuesday at Georgetown University, saying he lacked “patience for anyone who denies that this problem is real.” ... “We don’t have time for a meeting of the flat-Earth society.”¹⁶¹

How did scientists come up with the fantastic distance that the North Star is from the earth? Simple—they made it up. There is no evidence to support that distance. Indeed, all of the fantastic distances in the heliocentric model were simply hypothesized to explain why all the stars move in unison, without any parallax. Parallax is the movement of one star in relation to another star that would be expected to be seen if the earth were spinning and orbiting in space around the sun.

What is observed, however, is no parallax between the stars whatsoever. With the exception of a few wandering stars, which today are called the planets of the alleged solar system, the stars move in unison, as though they are part of one great single mass. That proved to be a problem for the heliocentric model. Indeed, such movement makes the heliocentric model impossible. In order to explain away the lack of parallax, the priests of heliocentrism simply expanded the universe in their minds and scientific papers and argued since the stars are so far away that the parallax is imperceptible to us on earth. The problem with that argument is that no matter how far away the stars are, parallax would be discernable if the earth were moving. There is no parallax, because the stars are in fact within the firmament

(Genesis 1:14-18), moving in perfect unison over a flat, stationary earth.

 pdfelement

14

Path of Midnight Sun Disproves Heliocentrism

Below is a 360° panorama time lapse photograph showing the circuit of the sun over the Island of Loppa in the northern part of Norway, between 1900 hours, July 21st and 1800 hours, July 22nd.¹⁶² The Island of Loppa is at approximately 70° north latitude. The panorama photograph illustrates that in midsummer, north of the Arctic Circle, the sun stays above the horizon for 24 hours of the day. The photograph reveals the sun as it makes a complete circle over the head of the photographer as he took one picture each hour during a 24 hour period.¹⁶³ As you can see the sun is over a different area of the land at the time of each photograph. The picture was posted on a travel website in order to illustrate the beauty of the midnight sun in the north of Norway.

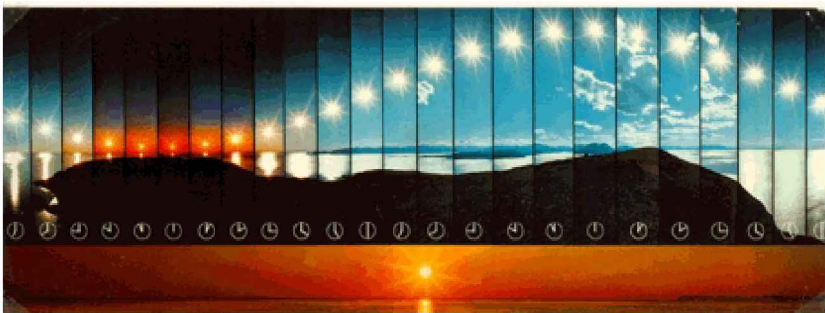

The above photograph is different from typical time lapse photographs, where the camera is left stationary. In the time lapse above, the photographer circles his camera a full 360° around his position. Each image of the sun is a separate photograph of the sun, with the background changing according to the movement of the camera as the photographer panned to shoot the sun once each hour.

The photographer has inadvertently proven that the sun circles over the flat earth. How so? The only way the sun would seem to circle the observer on a globular, spinning earth would be if the observer was standing directly over the North Pole. Any distance south of the north pole would create a zig zag, back and forth sun pattern in the sky if the earth were spinning and orbiting a 93 million mile distant sun, as purported in the heliocentric model. That zig zag motion would cause the topography to appear jagged at many of the seams when the photographic strips would be matched up, because both the speed and motion of the sun would not be constant relative to the photographer. The panorama photograph was taken above the Arctic Circle from approximately 1,400 miles south of the North Pole and has perfectly matched topography at each seam.

Below are two stills taken from a video by Rory Cooper demonstrating the proof of a flat earth.¹⁶⁴ The video illustrates that the only way that a time lapse series of photographs could depict a perfectly seamless topography is if the sun was circling 360° overhead north of the Arctic Circle within the boundaries of a flat earth.

The above time lapse photograph would be impossible if a spinning earth were orbiting around a distant sun, as is purported to be the case under the heliocentric model. The above time lapse photograph of the 360° circular path of the midnight sun showing a seamless topography proves that the earth is flat and the sun is circling overhead.

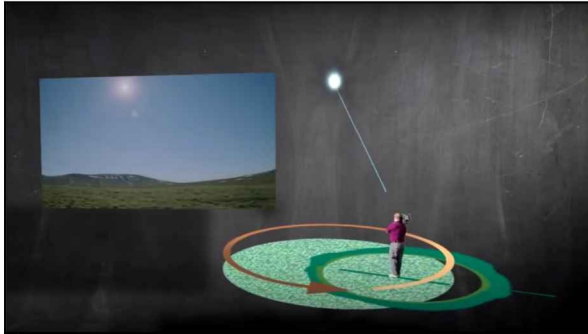

Figure 81: Image showing the position of a cameraman standing south of the North Pole on a spinning earth with the sun millions of miles away. The midnight sun would be seen by the observer to zig zag, back and forth over the horizon.

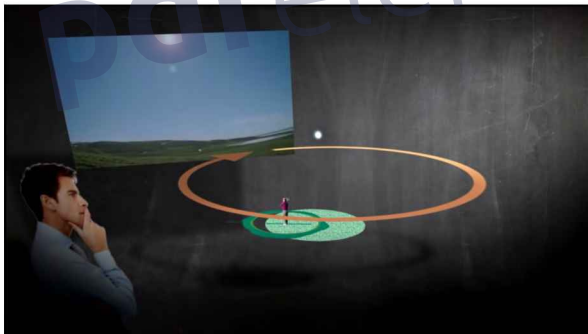

Figure 82: Image showing the reality of the sun circling 360° overhead within the boundaries of a flat earth. That is what is seen in all time lapse photographs of the midnight sun, north of the Arctic Circle.

15

Lunar Eclipses Explained

Many will point to a lunar eclipse to refute any notion of a flat earth. The argument being that both the sun and moon could not be smaller lights over a much larger earth, because an eclipse is argued to be the blocking of the sunlight on the moon by the intervention of the spherical earth. The problem with that postulation is that it assumes facts that have never been proven. That is, it assumes that a lunar eclipse is caused by the passing of a spherical earth between a distant sun and the moon. That supposed “scientific fact” can be proven to be a fallacy.

Samuel Rowbotham explains many historical instances where both the sun and moon were visible to an observer above the horizon during an eclipse of the moon. If the eclipse of the moon is caused by the intervention of the supposed shadow of a spherical earth between the sun and the moon, it would be impossible for an observer on the earth to see both the sun and the eclipsed moon above the horizon. Rowbotham cites an instance “on the 19th of July, 1750, when the moon appeared visibly eclipsed, while the sun was distinctly to be seen above the horizon.”¹⁶⁵ He cites another example where “[o]n the 20th of April, 1837, the moon appeared to rise eclipsed before the sun had set. The same phenomenon was observed on the 20th of

September, 1717.”¹⁶⁶ Those are not the only instances of this happening. Rowbotham continues:

In the lunar eclipses of July 17th, 1590; November 3rd, 1648; June 16th, 1666; and May 26th, 1668; the moon rose eclipsed whilst the sun was still apparently above the horizon. Those horizontal eclipses were noticed as early as the time of Pliny.¹⁶⁷

In a later 1881 edition of his book, Rowbotham cites to a Daily Telegraph report of the sun and eclipsed moon simultaneously appearing above the horizon. “On the 17th of January, 1870, a similar phenomenon occurred; and again in July of the same year.”¹⁶⁸

One might wonder if that same phenomenon is apparent today. In fact it has been a regular occurrence throughout history. As reported by Joe Rao for Space.com, “On Oct. 8, [2014] interested skywatchers should attempt to see the total eclipse of the moon and the rising sun simultaneously. The little-used name for this effect is called a ‘selenelion,’ a phenomenon that celestial geometry says cannot happen.”¹⁶⁹

Notice that Rao explains that the phenomenon of the sun and the eclipsed moon appearing above the horizon at the same time is “a phenomenon that celestial geometry says cannot happen.” Indeed, the very phenomenon is an impossibility under the heliocentric mythology. Modern scientists have even given a label to this impossibility: a “selenelion.” Of course, modern cosmologists must now define their new dogma in scientific terms so that the masses won’t discover that it is really a religious deception. How do they explain this phenomenon? Joe Rao presents the “scientific” explanation:

And indeed, during a lunar eclipse, the sun and

moon are exactly 180 degrees apart in the sky. ... a perfect alignment like this (called a "syzygy"), such an observation would seem impossible. But thanks to Earth's atmosphere, the images of both the sun and moon are apparently lifted above the horizon by atmospheric refraction. This allows people on Earth to see the sun for several extra minutes before it actually has risen and the moon for several extra minutes after it has actually set. As a consequence of this atmospheric trick, for many localities east of the Mississippi River, watchers will have a chance to observe this unusual sight firsthand. Weather permitting, you could have a short window of roughly 2 to 9 minutes (depending on your location) with the possibility of simultaneously seeing the sun rising in the east while the eclipsed full moon is setting in the west.¹⁷⁰

Rao would have the viewers of the phenomenon reject what their eyes see, and instead believe his "scientific" explanation that it is an "atmospheric trick." It is like the man caught by his wife in bed with another woman and explaining to his wife that she did not really see what she saw. He argues: "are you going to believe me or your lying eyes?" In like manner, the hapless eclipse observers must ignore what they see and yield their minds to the heliocentric dogma that they are not really seeing what is plainly before their eyes, the sun and eclipsed moon simultaneously above the horizon.



Figure 83: December 2011 Daytime Lunar Eclipse Viewed From New Mexico

atmospheric refraction of the light. The moon can be seen being eclipsed by a shadow that traveled over the moon from the top down. The atmospheric refraction explanation of the pseudo-scientists of modern heliocentricity requires the shadow to progress from under the moon. What actually happened, with the shadow progressing downward, refutes the light refraction explanation.

Below is a screen shot of a time lapse video of the December 2011 daytime lunar eclipse taken from Madison, Wisconsin.¹⁷²

The problem with Rao's explanation is that it cannot explain the observed event. To understand this, we must look at a time lapse film of a December 2011 daytime lunar eclipse taken from New Mexico.¹⁷¹ In the time lapse, the moon is being eclipsed as the sun rises above the horizon. The dark eclipse of the moon does not appear progressing from the bottom of the moon and going up as expected by the "scientific" explanation of the selenion as being due to



Figure 84: December 2011 Daytime Lunar Eclipse View from Madison, Wisconsin

Next we see a screen shot of a video taken of the December 2011 lunar eclipse viewed from East Saint Louis, Illinois, while both the sun and the moon were above the horizon.¹⁷³ The sun has risen behind the cameraman and the eclipse of the moon can clearly be seen with the shadow progressing from the top-down. That is just the opposite of what would be expected under the atmospheric refraction explanation given by the heliocentric pseudo-scientists.¹⁷⁴

Early in the East Saint Louis eclipse video, the narrator is standing between the eclipsing

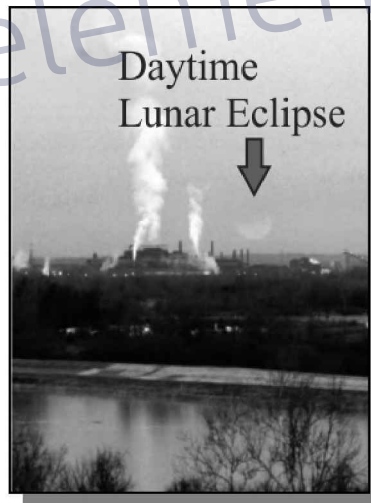

Figure 85: December 2011 Daytime Lunar Eclipse Viewed From East Saint Louis, Illinois

moon and the rising sun. He states that “behind me is a full moon which will soon be going into a full lunar eclipse as it sets, kind of a rare experience, while at the same time behind us the sun is already beginning to rise.”¹⁷⁵ The narrator then explains the unexpected occurrence of the shadow of the moon coming down across the moon. Rather than realize that such an occurrence is impossible if the earth were a spinning globe in space, he tries to reconcile the impossibility of what he is seeing with his ingrained heliocentric conditioning.

What I find very interesting is that I was expecting the shadow to come upward across the moon ... and actually it is going the other way around ... the shadow is creeping down across the moon, even though the sun is coming up over here and that must be because of the moon’s rotation around the earth, it’s moving farther up, even though the sun’s light is actually coming from over there, it’s actually coming underneath the earth ... the moon must be rotating around even though we’re turning so it looks like the moon is going down. It’s kind of an optical illusion, pretty cool.¹⁷⁶

His explanation makes no sense. He unconvincingly states that the light at the bottom of the moon is being caused by the light from the sun bending around the bottom of the earth and popping up on the other side to light the bottom of the moon. His explanation seems to be a variation on the atmospheric refraction argument, although it violates all known properties of light and refraction.

The narrator of the eclipse video explains that the sunrise is scheduled for 7:08 a.m. When 7:08 a.m. arrives, the narrator explains that the sun could be seen “peaking” above the horizon. He then states that “exactly 180 degrees in this direction and 180

degrees in the other direction is where the moon is. So there in a perfect line, the moon being this way and the sun being that way. If we drew a line from it [the sun] to the earth to the moon, it would be a nice perfect straight line, of course if it wasn't we wouldn't be having a lunar eclipse."¹⁷⁷ It is astounding that someone could be standing and looking at the sun above the horizon and in a straight line directly 180° across from him see the eclipsing moon and conclude that the earth he is standing upon is casting a shadow and causing the lunar eclipse. You would think that it would dawn on him (pun intended) that such an occurrence cannot be explained by the heliocentric model.

Daytime Lunar Eclipse Darkness Moves From Top Down

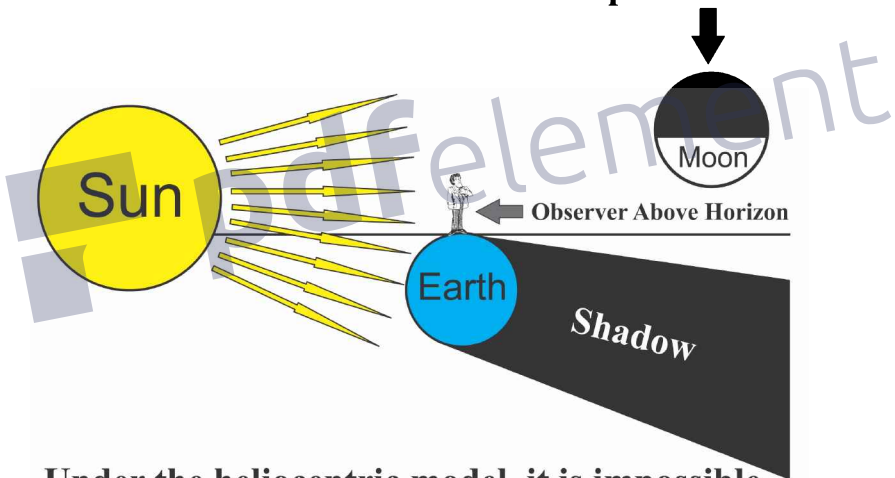

Under the heliocentric model, it is impossible for a daytime lunar eclipse to be caused by the earth's shadow.

The diagram above illustrates the impossibility of the earth's shadow causing a daytime lunar eclipse. Indeed, the progression of the shadow over the moon from the top down renders preposterous the explanation of heliocentric "scientists" that the phenomenon of a selenelion daytime lunar eclipse is due

to atmospheric refraction. For the absurd atmospheric refraction theory to have any viability, the shadow would need to travel from the bottom up, not the top down, as actually occurs.

If the blocking of the sun by the earth is not the cause of the lunar eclipse, then what is the cause? Rowbotham opines that there is a semi-transparent body passing in front of the moon.

We have seen that, during a lunar eclipse, the moon's self-luminous surface is covered by a semi-transparent something; that this "something" is a definite mass, because it has a distinct and circular outline, as seen during its first and last contact with the moon. As a solar eclipse occurs from the moon passing before the sun, so, from the evidence above collected, it is evident that a lunar eclipse arises from a similar cause--a body semi-transparent and well-defined passing before the moon; or between the moon's surface and the observer on the surface of the earth.¹⁷⁸

Rowbotham based his conclusion on his observations and the findings of the astronomers of his day.

That many such bodies exist in the firmament is almost a matter of certainty; and that one such as that which eclipses the moon exists at no great distance above the earth's surface, is a matter admitted by many of the leading astronomers of the day. In the report of the council of the Royal Astronomical Society, for June 1850, it is said:—

"We may well doubt whether that body which we call the moon is the only satellite of the earth."

In the report of the Academy of Sciences for October 12th, 1846, and again for August, 1847, the director of one of the French observatories gives a number of observations and calculations which have led him to conclude that,—

"There is at least one non-luminous body of considerable magnitude which is attached as a satellite to this earth."

Sir John Herschel admits that:— "Invisible moons exist in the firmament."¹⁷⁹

Sir John Lubbock is of the same opinion, and gives rules and formulæ for calculating their distances, periods.¹⁸⁰

At the meeting of the British Association for the Advancement of Science, in 1850, the president stated that,—

"The opinion was gaining ground, that many of the fixed stars were accompanied by companions emitting no light." "The 'changeable stars' which disappear for a time, or are eclipsed, have been supposed to have very large opaque bodies revolving about or near to them, so as to obscure them when they come in conjunction with us."¹⁸¹

...

We have now seen that the existence of dark bodies revolving about the luminous objects in the firmament has been admitted by practical observers from the earliest ages; and that in our own day such a mass of evidence has accumulated on the subject, that astronomers are

compelled to admit that not only dark bodies which occasionally obscure the luminous stars when in conjunction, but that cosmical bodies of large size exist, and that "one at least is attached as a satellite to this earth." It is this dark or "non-luminous satellite," which when in conjunction, or in a line with the moon and an observer on earth, is the immediate cause of a lunar eclipse.¹⁸²

 pdfelement

16

The Cold Light of the Moon

We need not rely on the opinion of Rowbotham or the eminent astronomers of his day. The very nature of the moonlight proves that the eclipse is almost certainly caused by a dark non-luminous body moving over the moon. The earth shadow as a hypothesis to explain an eclipse is refuted by the fact that at the middle point in the eclipse the moon does not go dark, as would be expected if sunlight were being blocked by a spherical earth. The moon, in fact, glows blood red at the apex of the eclipse. The moon turns a deep red hue, much like red-hot copper.¹⁸³ The moon is actually glowing red in the midst of what is supposed be the dark umbra of the earth's shadow.

That fact alone indicates that the moon is not a reflector of the sun's light, but rather is a light-source in-and-of itself. That confirms what God states in Genesis. God refers to both the sun and the moon as "lights." God did not call the moon a reflector of light, but rather a light in-and-of itself.

And God said, Let there be **lights** in the firmament of the heaven to divide the day from the night; and let them be for signs, and for seasons, and for days, and years: And let them be

for **lights** in the firmament of the heaven to give light upon the earth: and it was so. And God made two great **lights**; the greater **light** to rule the day, and the lesser **light** to rule the night: he made the stars also. And God set them in the firmament of the heaven to give light upon the earth, And to rule over the day and over the night, and to divide the light from the darkness: and God saw that it was good. (Genesis 1:14-18)

Indeed, Jesus stated, without equivocation, that the moon is not a reflector, but gives off its own light. “But in those days, after that tribulation, the sun shall be darkened, and **the moon shall not give her light.**” (Mark 13:24) The sun shall be darkened, and the corollary is that the moon shall not give her light. Obviously, that means that ordinarily the moon gives off its own light. *See also* Matthew 24:29; Ezekiel 32:7; Isaiah 13:10.

The truth of the bible is proven by true scientific observation. Moonlight can be proven **not** to be the reflection of the light from the Sun. The moon in fact gives off its own light. And thus an eclipse can only be explained by the intervention of a non-luminous body in front of the self-luminous moon. Rowbotham explains the unique characteristic of moonlight, which absolutely destroys the theory that the moon reflects the light from the sun.

A reflector will not throw off cold when heat is placed before it; nor heat when cold is presented. If a red light is received, red light will be returned, not blue or yellow. If the note C is sounded upon any musical instrument, a reflector will not return the note D or G, but precisely the same note, altered only in degree or intensity.

If the moon is a reflector of the sun's light, she

could not radiate or throw down upon the earth any other light than such as she first receives from the sun. No difference could exist in the quality or character of the light; and it could not possibly differ in any other respect than that of intensity or quantity. ...

We have then, in order to know whether the moon is a reflector, merely to ascertain whether the light which we receive from her is, or is not the same, in character as that received from the sun.

1st. The sun's light is generally, and in an ordinary state of the atmosphere, of an oppressive, fierce, semi-golden, pyro-phosphorescent character; while that of the moon is pale, silvery and gentle; and when shining most brightly is mild and non-pyrotic.

2nd. The sun's light is warm, drying, and preservative, or antiseptic; animal and vegetable substances exposed to it soon dry, coagulate, shrink, and lose their tendency to decompose and become putrid. Hence grapes and other fruits by long exposure to sunlight become solid, and partially candied and preserved; as instanced in raisins, prunes, dates, and ordinary grocers' currants. Hence, too, fish and flesh by similar exposure lose their gaseous and other volatile constituents and by coagulation of their albuminous and other compounds become firm and dry, and less liable to decay; in this way various kinds of fish and flesh well known to travellers are preserved for use.

The light of the moon is damp, cold, and powerfully septic; and animal and nitrogenous vegetable substances exposed to it soon show symptoms of putrefaction. Even living creatures by long exposure to the moon's rays, become morbidly affected. It is a common thing on board vessels going through tropical regions, for written or printed notices to be issued, prohibiting persons from sleeping on deck exposed to full moonlight, experience having proved that such exposure is often followed by injurious consequences.¹⁸⁴

Can Rowbotham's claims regarding the different nature of moonlight and sunlight be proven? In fact, it has been proven. Rowbotham reveals that "[i]n the 'Lancet' (Medical Journal), for March 14th, 1856, particulars are given of several experiments which proved that the moon's rays when concentrated, actually reduced the temperature upon a thermometer more than eight degrees."¹⁸⁵ It is common knowledge that the magnification of the sun's rays increases the temperature at the point at which the magnified beam is cast. The moon, with its cold magnified light, cannot therefore be reflecting the warm light from the sun.

Experiments done as recently as 2016 confirm the results of the Lancet experiments. Magnifying the cold light of the moon resulted in demonstrated measurable cold temperature caused by the moonlight. One experimenter used a strong magnifying Fresnel Len (although he did not indicate its magnification strength). He detected a difference of approximately 8.1° Celsius (14.6° Fahrenheit) between the surface upon which magnified moonlight was cast, which measured 4° Celsius (39.2° Fahrenheit) and the adjacent surface area shaded from moonlight, which measured 12.1° Celsius (53.8° Fahrenheit).¹⁸⁶

Is magnification of the moonlight necessary to measure

the coolness of moonlight? It is not. Experimenters have found that objects in moonlight are measurably colder than those shaded from the moonlight, without any magnification of that moonlight. One experimenter measured an approximate difference of 7.2°F between a white ceramic plate placed in moonlight (44.2°F) and a white ceramic plate shaded from the moonlight (51.4°F).¹⁸⁷ Another experimenter measured a difference of approximately 2°F between the portion of a metal ramp placed in moonlight (54°F) and the area of the same metal ramp that was shaded from the moonlight (56°F).¹⁸⁸ Yet, another experimenter found that the portion of a wallet left outside on the ground that was in the moonlight was 4°F colder than the portion of that same wallet that was shaded from the moonlight.¹⁸⁹

This author has used a dual laser infrared thermometer¹⁹⁰ and detected that material in moonlight is indeed colder than material shaded from the moonlight. Depending on the material, the difference in temperature ranged from approximately 2°F to approximately 6°F colder for material in moonlight than for material shaded from the moonlight. Of course, as expected, the very opposite was the case for material in sunlight versus material shaded from the sun. This author found that material in sunlight was detected to be approximately 20°F to 25°F warmer than the same material shaded from the sunlight.

Moonlight has a unique characteristic (it is cold) that is different from sunlight (which is warm). That proves that moonlight cannot be the reflected light from the sun. If it were, the reflected light would have to be warm. As we have seen, moonlight shone on objects make them colder as compared to objects protected from the moonlight by shade, whereas an object in sunlight is warmer than an object shaded from the sun. There is another difference in the two lights. While magnification of sunlight causes magnification of the heat from the sun, magnification of the moonlight does not cause magnification of the cold. Even extreme magnification of moonlight does not cause

significant reduced temperature. That is ~~unlike~~ extreme magnification of sunlight, which causes significant increased temperature. Dr. Henry Noad in his *Lectures on Chemistry* reveals results of experiments with magnified moonlight:

The light of the moon, though concentrated by the most powerful burning-glass, is incapable of raising the temperature of the most delicate thermometer. M. De La Hire collected the rays of the full moon when on the meridian, by means of a burning-glass 35 inches in diameter, and made them fall on the bulb of a delicate air-thermometer. No effect was produced though the lunar rays by this glass were concentrated 300 times. Professor Forbes concentrated the moon's light by a lens 30 inches in diameter, its focal distance being about 41 inches, and having a power of concentration exceeding 6000 times. The image of the moon, which was only 18 hours past full, and less than two hours from the meridian, was brilliantly thrown by this lens on the extremity of a commodious thermopile. Although the observations were made in the most unexceptional manner, and (supposing that half the rays were reflected, dispersed and absorbed), though the light of the moon was concentrated 3000 times, not the slightest thermo effect was produced.¹⁹¹

17

NASA Pictures of a Spherical Earth

Many will say that the earth cannot be flat since they have seen pictures from the National Aeronautics and Space Administration (NASA) showing a globular earth. Indeed, that is the principle evidence to which scientists point as proof of a spherical earth. Bill Nye is an example of such a “scientist.” Bill Nye is a famous television personality and science author, who is known as “The Science Guy.” His television science program has been recognized for its educational excellence with many awards. Bill Nye has a bachelor of science degree in engineering. But Bill Nye is more an actor than he is a scientist. He began his career as an actor playing different roles. His persona eventually morphed into his own show “Bill Nye the Science Guy,” where he portrays himself as a scientist. Nye recently appeared in a scripted video where he is asked if he can prove that the earth is a sphere. One of his replies was “if you’d like, look at pictures from space, where you see the earth as a sphere.”¹⁹²

In the video, Nye vouches for the authenticity of the NASA pictures of the spherical earth by saying “those pictures are not faked, if nothing else, here’s why you can tell they are not faked.”¹⁹³ This is the big moment now. Bill Nye “The Science

Guy,” award winning scientist and author, is now going to tell everybody how we can tell the pictures from NASA of the spherical earth are not fake. Bill Nye then gives his authoritative explanation, here it is: “Just to create the paperwork that NASA has created ... to send anything out into space, to send people into orbit or send them to the moon, that amount of paperwork would make faking it prohibitively expensive. No one could afford to generate that much documentation.”¹⁹⁴

Please dear reader reflect on the illogic of Bill Nye’s explanation. He is stating that his scientific opinion is that the paperwork that NASA has in fact generated to send people into space would make it prohibitively expensive to fake the photographs. Huh? His argument is laughable when one considers that NASA’s yearly budget is approximately 18 billion dollars.

But that is not the worst part. His explanation is illogical. He acknowledges that NASA has in fact generated the necessary paperwork to supposedly send people into space. Yet in the next breath he states that the paperwork to do so is so prohibitively expensive that NASA could not fake earth pictures. How does the paperwork expense of going into space even relate to faking pictures of earth? He is mixing the concept of the expense of the paperwork to actually go into space and the expense to fake the spherical earth photos. What he seems to be suggesting in his statement is that the paperwork to send someone into space to take fake pictures would be prohibitively expensive. But that is not the argument of those alleging that the pictures are fake. The argument of those alleging that the pictures are fake is that NASA did not go into space to take fake pictures, but that NASA faked the pictures using computer graphics and graphic artists in a studio on earth.

Nye does not realize it, but his argument implies that NASA did not actually go into space, because the massive expense of the paperwork to go into space makes it impossible to do so, because “no one could afford to generate that much

documentation.”¹⁹⁵ Bill Nye is not a true scientist. He is a propagandist. He has gotten so used to telling fantastic lies to keep the spherical earth myth going that he has lost touch with reality. He has gotten accustomed to people believing his lies, no matter how outlandish they are. He doesn't seem to realize that his lie about the prohibitive expense of the paperwork needed to go into space actually contradicts his argument that NASA really went to space. Nye just babbles nonsense, because he knows that most people will believe whatever he says, since he is the authoritative “Science Guy.” To even suggest that NASA, with a yearly budget of approximately 18 billion dollars, does not have sufficient money to fake pictures of the earth is quite simply absurd.

The most telling thing is that is the best argument that Bill Nye could come up with to prove the authenticity of the NASA photographs. This was not an off-the-cuff statement by Nye, where he was caught unprepared for an unexpected question. This was a scripted studio produced video, where he prepared his answer ahead of time. That was the best answer he could come up with.

Another problem with Nye's explanation is that it is contradicted by NASA itself. NASA has admitted that many of its purported earth “photographs” are not truly photographs at all but are rather renderings using computer software. You have read that correct, NASA has admitted that some of its photographs are fake. For example, NASA has gone on record acknowledging that the famous 2002 blue marble picture of earth that became the home screen for the 2007 Apple iPhone is a composite. NASA explains:

In 2002, NASA scientists and visualizers stitched together strips of brand new data, in natural color, collected over four months from the Moderate Resolution Imaging Spectroradiometer, or MODIS, instrument aboard Terra. They added a layer of clouds to create this composite Blue Marble that became one of the most iconic Earth

images of the new century when Apple selected it as their default background for the iPhone in 2007. A version of the MODIS Blue Marble is now used as the base layer in many visualizations of NASA Earth science data.¹⁹⁶

Indeed, when examining the blue marble composite, one can see duplicate clouds on its surface, which is a dead giveaway that it is not truly a photograph from space.

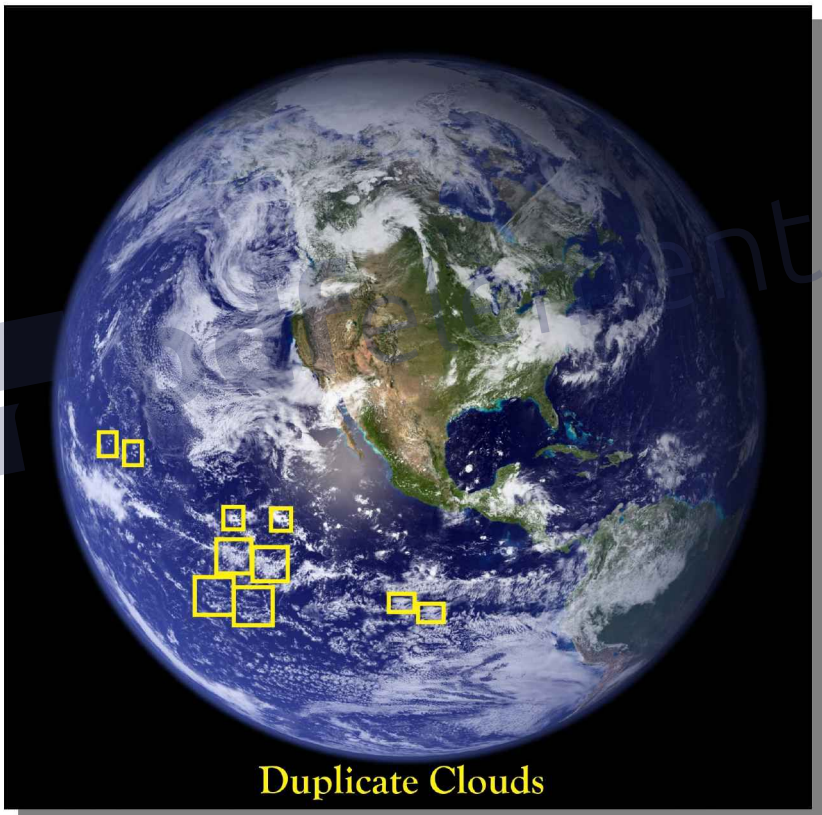

Figure 87: NASA's 2002 Blue Marble composite of the earth showing duplicate clouds.

Indeed, the 2002 Blue Marble image is a piece of artwork. Rob Simmon created the 2002 Blue Marble earth image that graced the screens of the first iPhones in 2007. At the time Simmons created the Blue Marble earth image, he was the Senior Program Analyst, who worked as the Lead Data Visualizer and Information Designer, Code 613, Climate and Radiation Branch, Earth Sciences Division at the Sciences and Exploration Directorate.¹⁹⁷ That is quite a title to hold; it even comes with a code; that sounds very secretive. Interestingly, Simmons admitted in an interview that the 2002 blue marble was created by him using Adobe Photoshop software. Simmons stated: “It is Photoshopped but it has to be.”¹⁹⁸ Simmons stated that he took data images from a NASA satellite to create the earth as “what I imagine it to be.”¹⁹⁹

If the earth is truly floating in an empty vacuum of space, a photograph of the earth does not need to be Photoshopped, as claimed by Simmon. NASA could simply send out a rocket with a camera into outer space and take a picture of the earth. NASA allegedly had no problem doing just that in 1972. However, it seems that with 30 years of advancement in technology NASA lost the ability to take pictures from space. The real reason that NASA must resort to Photoshop images of earth from space is that there is no outer space and earth not a sphere floating in that non-existent space.

In a 2012 interview for an article for NASA, Simmon explains the following:

The last time anyone took a photograph from above low Earth orbit that showed an entire hemisphere (one side of a globe) was in 1972 during Apollo 17. NASA’s Earth Observing System (EOS) satellites were designed to give a check-up of Earth’s health. By 2002, we finally had enough data to make a snap shot of the entire

Earth. So we did. The hard part was creating a flat map of the Earth's surface with four months' of satellite data. Reto Stockli, now at the Swiss Federal Office of Meteorology and Climatology, did much of this work. Then we wrapped the flat map around a ball. My part was integrating the surface, clouds, and oceans to match people's expectations of how Earth looks from space. That ball became the famous Blue Marble.

I was happy with it but had no idea how widespread it would become. We never thought it would become an icon. I certainly never thought that I would become "Mr. Blue Marble."²⁰⁰

Simmon reveals a couple of key facts: 1) Since the 1972 Apollo 17 moon mission and up until 2012, NASA had not taken a photograph of the entire hemisphere of the earth from space; 2) Simmon created the 2002 Blue Marble image of the earth by wrapping "the flat map around a ball;" and 3) Simmon's job was to create an image of the earth "to match people's expectations of how Earth looks from space."

Basically, the 2002 Blue Marble is not an actual image of the earth as seen from "space," but is rather Simmon's rendition of what he imagined would be an earth "to match people's expectations of how Earth looks from space."

There are a very few photographs of the earth coming from NASA that NASA claims are actual photographs from space depicting the globular earth. One of those pictures is the famous picture allegedly taken by astronauts during the Apollo 16 moon mission. Below is that picture.



Figure 88: Picture of Earth allegedly taken by the Apollo astronauts on April 16, 1972, using a hand-held Hasselblad camera, after leaving their alleged orbit of Earth.

NASA provided the following description of the picture on the NASA website, where it is posted, as follows:

Apollo 16 view of the Earth taken with a hand-held Hasselblad camera about an hour and a half after translunar injection on 16 April, 1972. Most of the United States is visible at right center, including Lake Michigan and Lake Superior and Florida. Mexico and part of Central America are also visible. The slightly different shade of blue below Florida is the Bahama Banks. The Earth is 12,740 km in diameter and

north is at roughly 1:00. (Apollo 16, AS16-118-18885).²⁰¹

The problem with the picture is that it is a hoax, and the description provided by NASA is a complete fabrication. Below is that same picture after it has been adjusted on Adobe Photoshop by increasing the brightness and lowering the contrast.²⁰² You can see clearly that the picture is manufactured. When the contrast is lowered and the brightness is increased, it reveals the area from which the Apollo 16 image of earth was cropped by the creators. After the Photoshop adjustments are made, the area from which the image of earth was cropped shows up black against a very dark green background. The black area outside the cropped image of the earth is distinct on a computer screen, but it does not show up well in print. A white line has been drawn around the black area outside the cropped image so that it can be seen better in print. The crop line indicates that the image was composed using graphic cropping techniques. It is not a photograph from the Apollo capsule. Once NASA realized that their hoaxed photo of the spherical earth was detectable in Adobe Photoshop, they replaced the posted photo with a different one that would not show the cropping line evidence of photo manipulation.

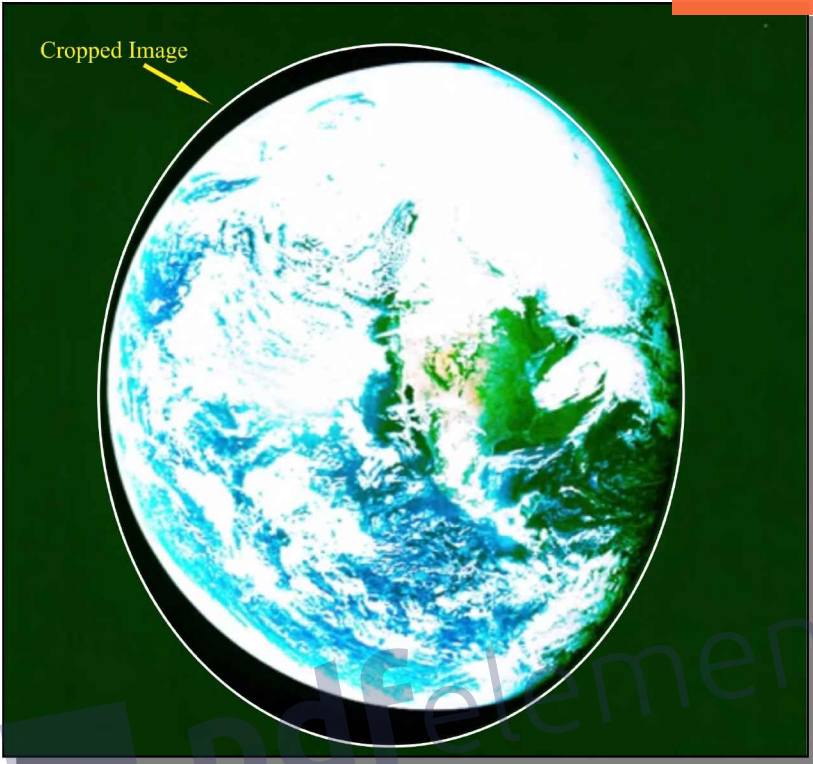

Figure 89: Image of Earth alleged to be from Apollo 16 with brightness raised and contrast lowered, revealing the area from which the image of earth was cropped. The white line has been added so that the crop line can be seen better in print.

There are other NASA photographs showing the earth to be a globe. Every one of them is a fabrication. Take for instance the image below, which was allegedly taken by the Apollo 17 crew.

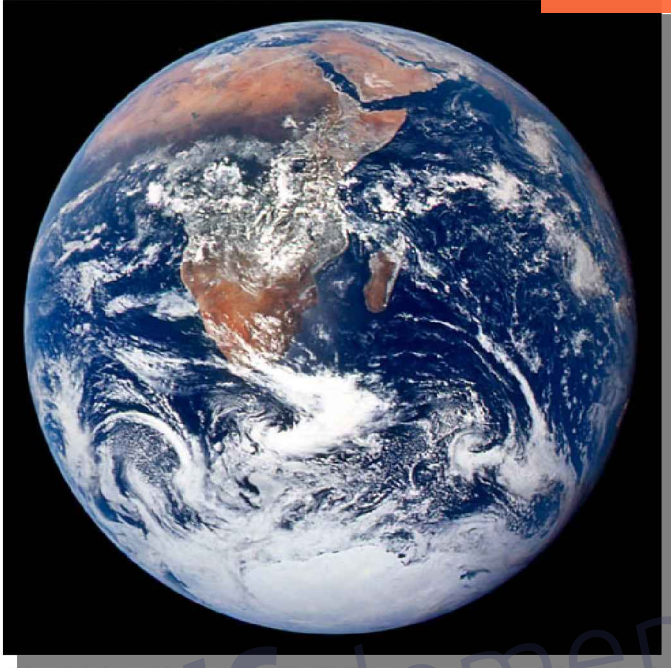

Figure 90: Alleged photograph taken during Apollo 17 mission to the moon.

Below is a description of the above photograph as it appears on the NASA website.

Apollo 17 hand-held Hasselblad picture of the full Earth. This picture was taken on 7 December 1972, as the spacecraft traveled to the moon, the last of the Apollo missions. A remarkably cloud-free Africa is at upper left, stretching down to the center of the image. Saudi Arabia is visible at the top of the disk and Antarctica and the south pole are at the bottom. Asia is on the horizon is [*sic*] at upper right. The Earth is 12,740 km in diameter. (Apollo 17, AS17-148-22725)²⁰³

The depiction of the land masses in the picture are wrong.

Below is a comparison of the above Earth image with the image provided to Google using the official data from the U.S. Government.²⁰⁴ The data used by Google in constructing its image of Earth comes from a number of organizations, including the National Geospatial-Intelligence Agency (NGA), the National Oceanic and Atmospheric Administration (NOAA), and the U.S. Navy, all of which are U.S. Government agencies.

The NGA, one of the agencies supplying data to Google, is an intelligence agency within the U.S. military. The NGA describes its mission as follows:

The National Geospatial-Intelligence Agency has a responsibility to provide the products and services that decision makers, warfighters, and first responders need, when they need it most. As a member of the Intelligence Community and the Department of Defense, NGA supports a unique mission set. We are committed to acquiring, developing and maintaining the proper technology, people and processes that will enable overall mission success.

Geospatial intelligence, or GEOINT is the exploitation and analysis of imagery and geospatial information to describe, assess and visually depict physical features and geographically referenced activities on the Earth. GEOINT consists of imagery, imagery intelligence and geospatial information.²⁰⁵

The globes in the comparison were lined up precisely in the same attitude. As you can see, however, the depictions in the globes of the land masses are quite different. For example, the upper horizontal line, which is drawn contiguous to the southernmost tip of Africa on the Apollo 17 image, shows that the southern

tip of Africa in the Google image falls much further south of the southern tip of Africa in the Apollo 17 image. Also, the African land mass is depicted much smaller in the Apollo 17 image. In addition, the lower horizontal line, which is drawn contiguous to the southern-most tip of Madagascar in the Apollo 17 image, shows that its southern tip of Madagascar falls further south of the horizontal line in the Google image. Also, the land mass of Madagascar is much larger in the Google image.

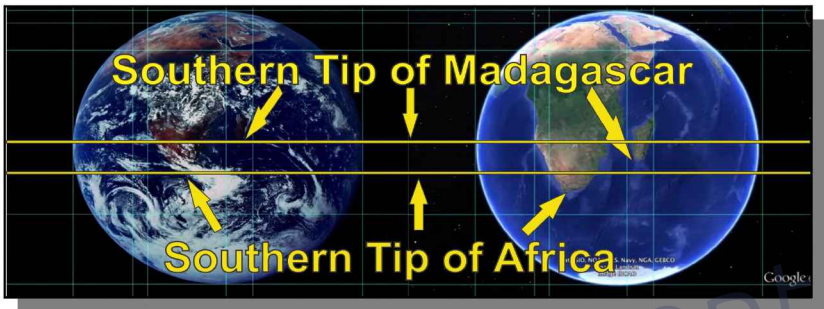

Figure 91: Comparison of the Apollo 17 Earth photograph and the image from Google that is based upon official U.S. government geographical data, showing inaccuracy in the Apollo 17 alleged photograph.

In the image below, you can see that the horizontal dimensions of the land masses on each of the two globes do not match up either. The Google image has the African continent much larger than the Apollo 17 image. You can see the vertical line that is placed contiguous to the western most point of the African continent in the Apollo 17 image. Follow that line up and you can see how much larger is the Google depiction of the African continent by the amount of land that is west of that line.

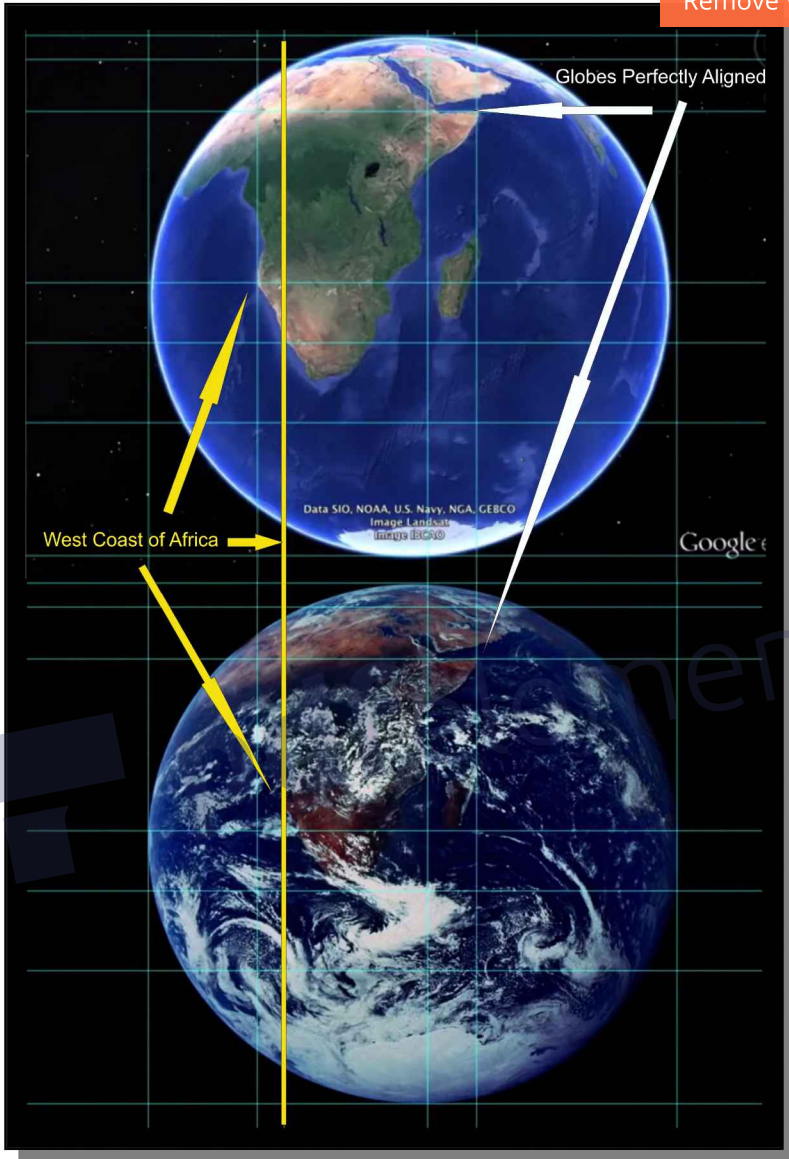

Figure 92: Comparison of the alleged Apollo 17 Earth photograph and the image of the earth from Google that is based upon official U.S. government geographical data, showing inaccuracy in the alleged Apollo 17 photograph.

Clearly, the alleged photographs provided by NASA for the earth are not real. NASA seems to be running a type of disinformation intelligence operation, whose purpose, in large part, is to convince a gullible public that the earth is a globe.

It has become the custom for the public and even NASA to call all of the alleged full earth NASA photographs of the earth Blue Marbles. The Apollo 17 astronauts allegedly took their Blue Marble snapshot of the earth on December 7, 1972.²⁰⁶ The Apollo 17 Blue Marble depicted above in this book (AS17-148-22725) is actually one of three separate and virtually identical Blue Marble photographs attributed to the Apollo 17 crew. All three of the photographs were allegedly taken between 4:59:05 and 5:08:14 after launch.²⁰⁷ The launch of Apollo 17 was at 12:33 a.m. EST (5:33 a.m. UTC/GMT). That would mean that the three Blue Marble photographs depicting the earth were allegedly taken between 5:32 a.m. and 5:41 a.m. EST (between 10:32 a.m. and 10:41 a.m. UTC/GMT).²⁰⁸ Two of the three photographs (AS17-148-22726 and AS17-148-22727) have been described by NASA as being taken at approximately 5 hours and 6 minutes after launch.²⁰⁹ That would put the time of those two pictures at 5:39 a.m. EST (10:39 a.m. UTC/GMT).²¹⁰

Since all three Blue Marble photographs of the earth show identical cloud formations and attitude of the earth, certainly NASA would have to claim that they were taken in close succession to one another. The nomenclature used by NASA is sequential. We know, therefore that AS17-148-22725 was the first picture of the three Apollo 17 Blue Marble Earth photographs taken. Since NASA must claim that it was taken in close in time to the other two pictures, because they are virtually identical, we can infer that the time AS17-148-22725 was allegedly taken as being no more than one minute prior to the other two pictures. That would put the time that AS17-148-22725 was taken at approximately 5:38 a.m. EST (10:38 a.m. UTC/GMT). In any event, a few minutes difference either way will not effect our

analysis.

Why is the approximate time of the Apollo 17 Blue Marble photograph important? Because the photograph depicts a fully lit earth. Since we can see the entire sunlit half of the earth, we know that the part of the earth that is not seen is in darkness. That fact proves that the Apollo 17 Blue Marble photograph is a fraud. How so? Because, Antonio Subirats discovered that on December 7, 1972, at approximately 5:38 a.m. EST (10:38 a.m. UTC/GMT), India, Europe, and Western Russia, and Western China were in complete daylight.²¹¹ In addition, almost all of South America (except the northwest coast, made up of the western parts of Ecuador, Columbia, and Venezuela) and the western most part of Australia were in complete daylight. Yet, in the Apollo 17 Blue Marble photograph, we can see that none of Europe, Western Russia, Western China, South American, or Australia are visible; they are all on the dark side of the Blue Marble. A viewer looking straight on to a fully illuminated 180° of a globe is able to see every part of the half that is illuminated. The other half of the globe is out of view and must necessarily be in darkness.

Indeed, the actual daylight that is experienced each day on the earth proves that all depictions of the spherical earth, including Google Earth, are false. If you look at Google's depiction of Earth you will see that at the same attitude as depicted in the Blue Marble, neither Europe, Western Russia, Western China, South America, nor Western Australia are depicted on the Google Earth depiction of the globe. Yet, at that time and date all of those areas should be receiving the sun's light. Indeed, when you compare the sun cast for any day with any correlated attitude of the spherical earth, you will find it impossible to match the sun's actual illumination of the earth with the illumination theorized by the spherical model of the earth. The cast of the sunlight as actually experienced each day can only be manifested on a flat earth. The spherical earth is thus shown to be false.

In the picture below we see the circle indicating the dimensions of the Apollo 17 Blue Marble superimposed on a map showing the position of the sun and moon on December 7, 1972, at 10:38 a.m. UTC/GMT.²¹²

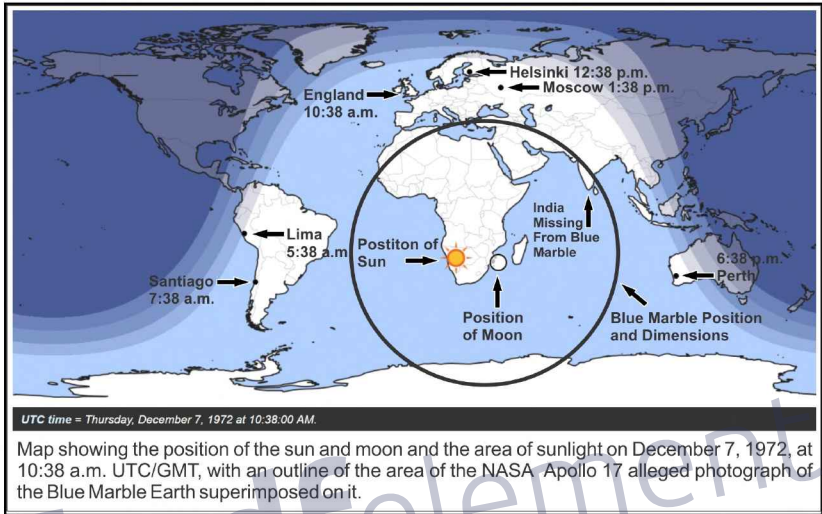

The fact that England cannot be seen on the illuminated side of the Blue Marble proves the fallacy of the globular earth model. England is on the dark side of the earth on the Apollo 17 Blue Marble Photograph. However, it was 10:38 a.m. UTC/GMT in Greenwich, London, England, at the time of the alleged Blue Marble photograph. Obviously, it was daylight in Greenwich, London, England at 10:38 a.m. UTC/GMT on December 7, 1972, when the Apollo 17 Blue Marble photograph was allegedly taken. Furthermore, when the Blue Marble picture was supposed to have been taken, it was 12:38 p.m. in Helsinki, Finland. Clearly, at 38 minutes after noon in Helsinki, it was daytime. Yet, according to the Blue Marble, Helsinki, Finland, is supposed to be in darkness. At the time the alleged photograph of the Blue Marble was taken, it was 1:38 p.m. in Moscow. It was certainly daylight at that time in Moscow. The Blue Marble, however, has Moscow in complete

darkness at 1:38 in the afternoon. Obviously the Apollo 17 Blue Marble is simply wrong in its depiction of the earth.

If the earth were a sphere, the position of the sun on December 7, 1972, at 10:38 a.m. UTC/GMT, should have created a gibbous earth, and not the full earth as depicted in the Apollo 17 Blue Marble. Additionally, the Blue Marble graphic artist failed to include India in his artwork. At that particular attitude, India should be visible on a spherical earth, but it is completely missing from the Blue Marble.

Some heliocentrists have claimed that the light passes around the globe and would thus illuminate the back side of the globular earth depicted in the Apollo 17 Blue Marble Earth photograph. The problem with that argument is that it is a physical impossibility, which can be demonstrated with a ball and a flashlight outside at night. The existence of atmosphere on the earth would not change this fact. NASA knows this and factors it into its construction of computer generated images (CGI) of the spinning earth. NASA and space agencies from other countries always portray the earth's terminator as being a boundary line at a 90° orientation to the sun, because that is how it must be for all spheres facing a light source. The backside of the globe is 180° in darkness, with the boundary marked by the terminator. The sunlit side, in contrast, is covered by 180° of sunlight that ends at the terminator. This fact is illustrated in the alleged photograph supposedly taken by the Himawari 8 geostationary satellite. The photograph below is a screen-shot from an alleged time lapse, which is taken at the point where the purported sun has illuminated 180° of the earth and the terminator is seen at a 90° angle to the position of the sun.

The theory that the sun's light can wrap around the globe on either side of the terminator beyond 180° is impeached by the physical laws, which the Himawari 8 animators seem to acknowledge in their CGI of the earth. Even gibbous depictions of



View of illuminated quarter earth allegedly taken from the Himawari 8 geostationary satellite showing that light cannot pass beyond the terminator line that is 90 degrees to the sun.

the earth requires a 180° split between light and darkness. The gibbous depictions of the earth are all a matter of perspective created by CGI. Incidentally, in the Himawari 8 alleged photograph there are no lights in the cities in eastern Australia. Don't Sydney and Melbourne have electricity? Obviously, the Himawari 8 imagineers forgot to include city lights in their CGI of the earth. I guess one cannot think of everything when constructing an earth CGI.

The fraud of the Apollo 17 Blue Marble can be clearly understood when one considers just how far the from the terminator on the Blue Marble were the cities that were supposed to be in darkness on the Blue Marble but in fact enjoyed daylight on December 7, 1972, at 10:38 a.m. UTC/GMT. Assuming the earth is a sphere as depicted by the Blue Marble, on December 7, 1972, at 10:38 a.m. UTC/GMT, Moscow was supposed to be more than 1,000 miles distance from the terminator of the spherical Blue Marble earth and in darkness dropping more than 126 miles on a curve below the horizon from the illuminated portion of the Blue Marble. On that date and time, Helsinki was supposed to be more than 1,300 miles distance from the terminator of the Blue Marble and in darkness dropping more than 213 miles on a curve below the horizon from the illuminated portion of the Blue Marble. London was supposed to be more than 1,100 miles distance from the terminator of the Blue Marble and in darkness dropping more than 152 miles on a curve below the horizon from the illuminated portion of the Blue Marble. Perth was supposed to be more than

1,200 miles distance from the terminator of the Blue Marble and in darkness dropping more than 181 miles on a curve below the horizon from the illuminated portion of the Blue Marble. Both Lima and Santiago were supposed to be more than 3,000 miles distance from the terminator of the Blue Marble and in darkness dropping more than 1,135 miles on a curve below the horizon from the illuminated portion of the Blue Marble.

These fantastic distances from the Apollo 17 Blue Marble's terminator would have all of these cities plunged into darkness, yet each and every one of them was enjoying daylight on December 7, 1972 at 10:38 a.m. UTC/GMT. That proves that the Apollo 17 Blue Marble is a NASA hoax. The only way that these cities could have been enjoying daylight at that time and date is if the world is in fact flat.

Both the Google Earth globe and the Apollo 17 Blue Marble have similar discrepancies regarding their terminators and the real area covered by the sun. The dimensions of the Google Earth (or any globe for that matter) cannot account for the area of daylight that is experienced on Earth each day. Only a flat Earth accurately explains the area illuminated by the sun.

In the 2001 movie, *A Funny Thing Happened on the Way To the Moon*, Bart Sibrel presents compelling evidence that the Apollo Moon landing missions that took place between 1969 and 1972 were elaborate hoaxes. One of the most compelling pieces of evidence is a piece of videotape footage that was inadvertently sent to Sibrel by NASA. The videotape shows Apollo astronauts Neil Armstrong, Buzz Aldrin, and Michael Collins allegedly in the Apollo space capsule narrating their view of the moon at a time that they claimed that they were 130,000 miles from Earth and on their way to the moon. The problem is that the videotape, which was never supposed to be seen by the public, shows the astronauts faking the pictures of Earth, by using some sort of transparency against the cabin window.

Matthew Boylan states that he was a former NASA Operational Graphics Manager. He worked for years creating photo-realistic computer graphics for NASA.²¹³ He was originally hired by NASA because of his unique skill as an artist at creating images that were so realistic, they were virtually indistinguishable from photographs.

NASA saw his potential and decided to bring him in on their secret. Boylan describes a revelation made to him at a party attended by NASA officials, which Boylan considered to be some sort of initiatory-rite for him. During the party, one of the NASA officials explained to him in detail how the earth was in fact flat and that NASA's purpose is to fool the public into believing that the earth is instead a round ball spinning and orbiting the sun. Boylan began researching the issue and became convinced that the earth is in fact flat and that NASA's reason for existence is to promote a false heliocentric globular earth model.²¹⁴ He has since left NASA and exposed their deception.

Boylan points to evidence that the earth images from NASA are manufactured in the time-lapse pictures of the earth; the clouds remain static without changing their form or position during hours of time lapse. Such an occurrence would be impossible in the real world. Boylan states that all photographs from the Hubble Space Telescope are NASA hoaxes.

Below is a purported picture of the earth taken on July 6, 2015, and subsequently posted on the NASA website. It is described by NASA as follows:

A NASA camera on the Deep Space Climate Observatory satellite has returned its first view of the entire sunlit side of Earth from one million miles away. This color image of Earth was taken by NASA's Earth Polychromatic Imaging Camera (EPIC), a four megapixel CCD camera

and telescope.²¹⁵

NASA can waste millions on their space launches, yet they use a pathetically anemic 4 megapixel CCD camera. One can search online and find for sale to the general public a 16 megapixel CCD camera for less than \$10,000. Yet, NASA sends their alleged Deep Space Climate Observatory satellite into space with a camera having a mere 4 megapixel resolution. It seems that NASA is bending over backwards to provide the lowest resolution picture of earth with which they can get away. Why would they do that? Because it is easier to pull off the spherical earth myth with low resolution photographs. The higher the resolution, the more difficult it is to create a realistic globular earth. Higher resolution will show more detail and hence show signs of artificiality. The picture below is not actually a picture of earth from space, as alleged by NASA.

 pdfelement



Figure 95: Photograph of earth allegedly taken from a camera aboard the NASA Deep Space Climate Observatory, from a distance of one million miles.

NASA states on its website that the image is made up of three layers of pictures taken using the satellite's digital camera:

The image was generated by combining three separate images to create a photographic-quality image. The camera takes a series of 10 images using different narrowband filters -- from ultraviolet to near infrared -- to produce a variety of science products. The red, green and blue channel images are used in these color images.²¹⁶

NASA admits that the image is a composite, but maintains that it is a composite of three photographic images, all taken from a million miles away with a digital camera on the Deep Space Climate Observatory satellite. Why was it necessary to make a composite image at all? Why not just take a picture of earth? Because, there is no Deep Space Climate Observatory satellite and the earth is not a globe. The image is a piece of very clever artwork. NASA knows that the layers in the image would likely be discovered in the future and decided to admit it is a layered image in order to have a plausible reason for the layers.

In any event, the claim by NASA that the image is an accurate photograph of earth from space, using its “Earth Polychromatic Imaging Camera (EPIC),” is a demonstrable deception. NASA claims that the image is a composite of three photographs of earth taken from space. In actuality, it is a composite of computer and human generated imagery. What proof is there of that? A professional photographer and designer, with over 20 years experience using Adobe Photoshop software, discovered that the NASA photograph was created using Adobe Photoshop software.²¹⁷ The expert inverted the image, using Photoshop, and discovered that whoever created the photograph used the Photoshop round marquee tool. He discovered the distinct stair step outline, which is unique to the Photoshop software marquee tool, ringing the circumference of the earth in the NASA photograph.

The expert also discovered that there were square pixel remnants of sky, clouds, and water that were mistakenly left behind underneath the black background applied around the earth image. There should not be sky, clouds, and water floating in square pixels in space. The expert’s professional opinion is that NASA’s purported picture of the earth is not a photograph from a million miles in space, but rather the creation of a graphic artist, using Adobe Photoshop software.²¹⁸

We don't need an expert to detect that the July 8, 2013 Deep Space Climate Observatory satellite picture is not a candid photograph of earth from space. The image itself contains the proof that it is a forgery. If you look at the lower southwest portion of the globe image above, you can see that the graphic artist who drew the clouds, drew in the word "SEX," upside down. With the image flipped 180° (below), the word "SEX" in the cloud formation can be seen right side up in the northeast portion of the globe.



Figure 96: NASA alleged photograph of the earth flipped 180°, revealing "SEX" written in the cloud formation.

It is notable that the word “SEX” in the clouds is written at a 23.4° vertical angle, which is the supposed tilt of the globular earth under the heliocentric model. The above box drawn around the word “SEX” is at precisely a 23.4° vertical angle. There is no evidence of the supposed 23.4° earth tilt. If there is no evidence for it, how was that angle arrived at? Recall that heliocentrism is a religion, and so you can expect the angle picked for the supposed tilt of the earth to have religious significance. The high priests of the heliocentric religion did not arbitrarily pick 23.4° . The adjacent horizontal angle to the supposed 23.4° tilt of the earth under the heliocentric model is 66.6° ($90^\circ - 23.4^\circ = 66.6^\circ$). “Here is wisdom. Let him that hath understanding count the number of the beast: for it is the number of a man; and his number is Six hundred threescore and six.” Revelation 13:18. The word “SEX” in the clouds is clear evidence that the image, which NASA purports to be a photograph of earth, is an artistic rendition; it is a fiction.

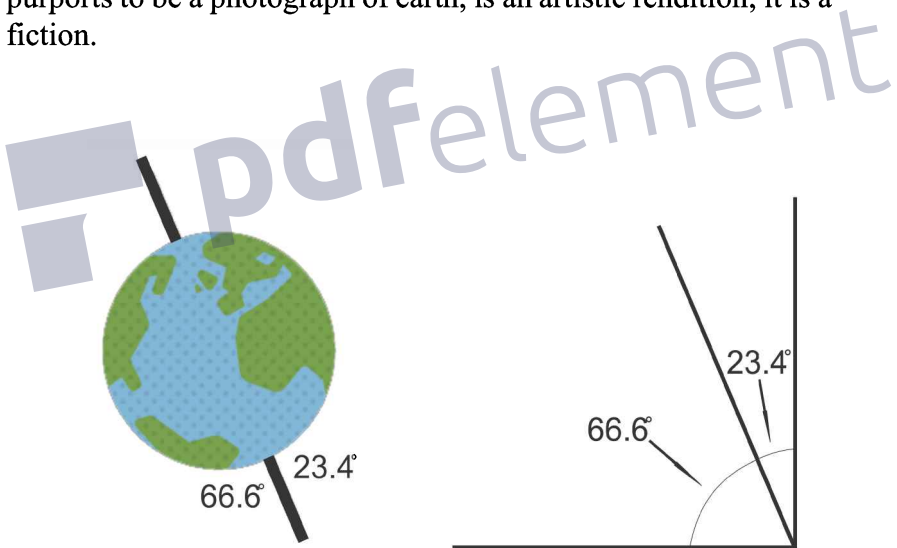

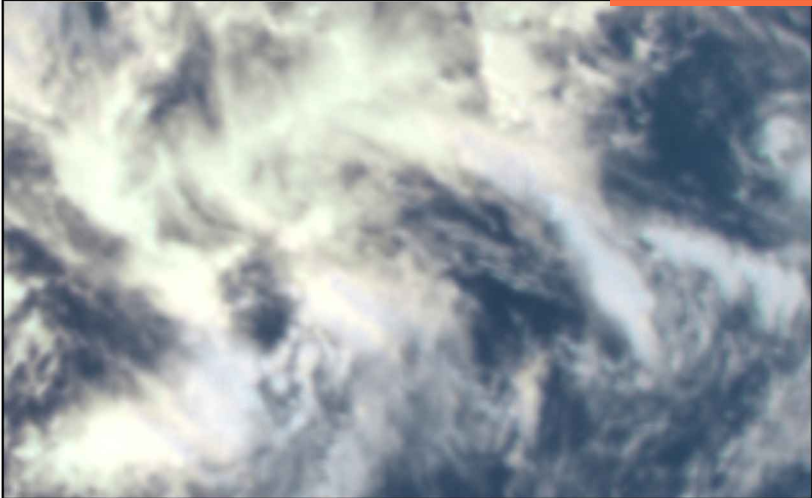
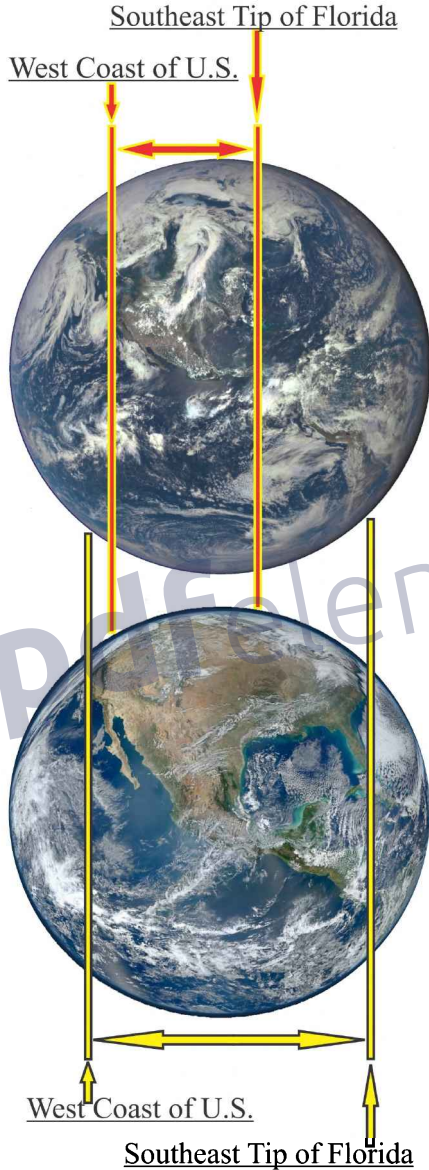

Figure 98: Closeup of “SEX” written in clouds on image of earth that NASA claims is a photograph from space.

The fraud of NASA is most evident when comparing one NASA Earth photograph with another NASA Earth photograph. The dimensions of the continents depicted on several of NASA’s alleged Earth photographs do not match, which is a dead giveaway that they are fabrications. For example, below is a comparison of NASA’s alleged Deep Space Climate Observatory (DSCO) photograph of the earth taken on July 6, 2015²¹⁹, with a composite photograph allegedly taken from the NASA’s Earth-observing satellite - Suomi NPP, on January 4, 2012.²²⁰ Notice the glaring difference in the size of the North American Continent on the two globes. The globes are identical in outer dimensions, yet the North American continent in the Suomi NPP photograph on the bottom is almost twice the size of the North American continent in the DSCO photograph on the top. That is impossible if the two photographs were in fact photographs of the earth. The startling differences in continent sizes is proof of NASA disinformation.

NASA's DSCO Alleged 2015 Earth Photo



NASA's Suomi NPP Alleged 2012 Earth Photo

It is not just the many differences in the earth images from NASA that prove the NASA hoax. Sometimes the NASA hoax can be proven through identical Earth images from NASA.²²¹ For example, On May 18, 1969, NASA alleged that the Apollo 10 astronauts took a video of the earth as they were in their translunar phase of their moon orbiting mission.²²² The translunar phase is just NASA-speak for traveling toward the moon. Six days later, on May 24, 1969, NASA documented that the Apollo 10 astronauts took another video shot of the earth during their transearth stage.²²³ The transearth stage is the stage where they are traveling back to Earth from the moon. The NASA hoax is proven when one compares the image of the earth from the translunar phase video on May 18th with the image of the earth from the May 24th transearth phase video. The Earth images in both videos are identical, right down to the cloud formations. It is impossible for the earth to have identical cloud formations six days apart. Clearly, NASA was using the same image of the earth in both video shots to scam the public into believing that the astronauts were traveling from the spherical earth to the moon and back again.

Identical Cloud Formations On Earth Six Days Apart



Still frame from a video alleged by NASA to have been taken by astronauts aboard the Apollo 10 spacecraft on May 18, 1969, as the astronauts were traveling away from the earth toward the moon.



Still frame from a video alleged by NASA to have been taken by astronauts aboard the Apollo 10 spacecraft on May 24, 1969, as the astronauts were traveling away from the moon toward the earth.

Below is a picture of the earth that is alleged by NASA to have been taken from the moon by astronauts during the Apollo 17 mission. To the right of that image is the same image with the output levels adjusted upward in Photoshop.²²⁴ With the levels adjusted upward, there is revealed around the image of the earth a square box. That box is evidence that the image of the earth was pasted onto a black background by a graphic artist; it was not photographed from the surface of the moon, as alleged by NASA.

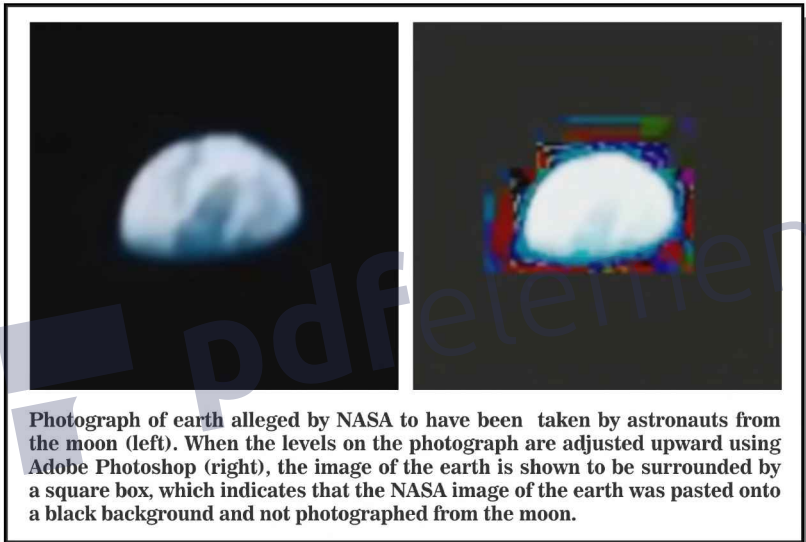

18

NASA Moon Missions

David Groves has opined that the picture of Buzz Aldrin descending from the Lunar Excursion Module (LEM) onto the moon's surface was illuminated with artificial light. David Groves has a BSc (Honors) Class 1 in Applied Physics and has a PhD in Holographic Computer Measurement. Dr. Groves is also a Chartered Physicist and a Member of the Institute of Physics. Dr. Groves founded Quantec Image Processing in the UK. Dr. Groves has 25 years experience analyzing photographs. He uses holographic computer techniques for analyzing images and obtaining three dimensional information from two dimensional photographs. He used those techniques to analyze the famous photograph of Buzz Aldrin descending the LEM's ladder to the surface of the moon during the Apollo 11 moon mission.

Dr. Groves' crack team of experts at his company examined the Aldrin Apollo 11 picture. They noticed a number of anomalies in the photograph that indicated that it was illuminated with artificial lighting. Most notably, there was a lighting hot spot on Aldrin's boot. Dr. Groves had access to that type of boot. Dr. Groves knew the focal length of the camera lens and the orientation of the boot. With that information, he was able to

determine that the hot spot on the boot was caused by an artificial light source that was between 24 and 36 centimeters to the right of the camera.²²⁵ NASA has gone on record explaining that there was no artificial lighting used in any of the pictures taken from the moon.

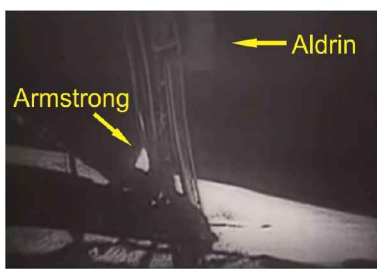

Apollo 11 Video ↑
Aldrin in Darkness

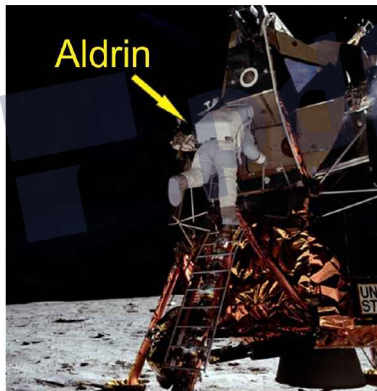

Apollo 11 Photo ↑
Aldrin Illuminated

In addition to NASA's official statement that there was no artificial lighting used for the NASA photographs from the moon, it can be clearly seen in the televised NASA video that Neal Armstrong had no artificial light source when he was standing behind the LEM in position when Aldrin descended the ladder. No artificial lighting was present. In the video, Aldrin is on the side of the LEM, awash in the darkness of the shadow. It is so dark in the area of Aldrin's descent that he can barely be seen. In order for a camera to take the brightly-lit picture of him, as published by NASA, artificial lighting had to be used. Dr. Groves' expert analysis of the photo proved that artificial lighting was in fact used. NASA maintains,

and the video shows, however, that there was no artificial light source present on the purported moon surface.²²⁶ This is proof that the photograph was not taken on the moon, but in a studio.

Mary D. M. Bennett, Stan Gooch, and David S. Percy collaborated with photographic expert Jack White in analyzing other NASA photographs. Percy, FRSA, ARPS, is an Associate of the Royal Photographic Society and an award winning film and television producer. Percy was nominated Film Cameraman of the Year at BISFA (forerunner of the IVCA). Bennett, Gooch, Percy, and White discovered evidence of photographic fakery and staging of scenes in a studio of the Apollo moon landing photographs. They have posted their evidence on their website at www.aulis.com.²²⁷

In the picture below you can see that the LEM for the Apollo 15 moon mission is in view in one photograph, but in a later photograph, with the same backdrop, the LEM is gone. Percy, *et al.*, explain:

Of course although the backdrops match, the foregrounds are different. This was probably to help disguise the fact that the setting has been used for both a general scene, (photo AS15-82-11082) and an alternative setting for the LM (photo AS15-82-11057). It is highly likely that there was a finite number of backdrops available to the photographic team and that NASA failed to anticipate such meticulous analysis of the imagery.²²⁸

The LEM is the vehicle used to land on the moon. There would be no one on the moon to take a picture of the landing site before the LEM arrived. Once the LEM lands, it remains stationary and cannot be moved. A picture of the LEM landing site without the LEM, therefore, would be impossible. The disappearance of the LEM from view in the picture can only be explained by the fact that the purported moon pictures were not taken from the surface of the moon.



Figure 103: Annotations to NASA Photos by Jack White.

The LEM disappearing act also happened during the Apollo 17 moon mission. In the picture below, Jack White reveals his discovery that the same backdrop was used for three different photographs from the Apollo 17 moon mission. Clearly, nobody would be there to take the pictures without the LEM, which is the moon landing craft for the mission. Yet, we see that in two out of the three pictures, the LEM is missing from its landing area. That

is convincing proof that all three photographs were taken from a studio on Earth; the photo editors simply used the same backdrop for all three photos.²²⁹

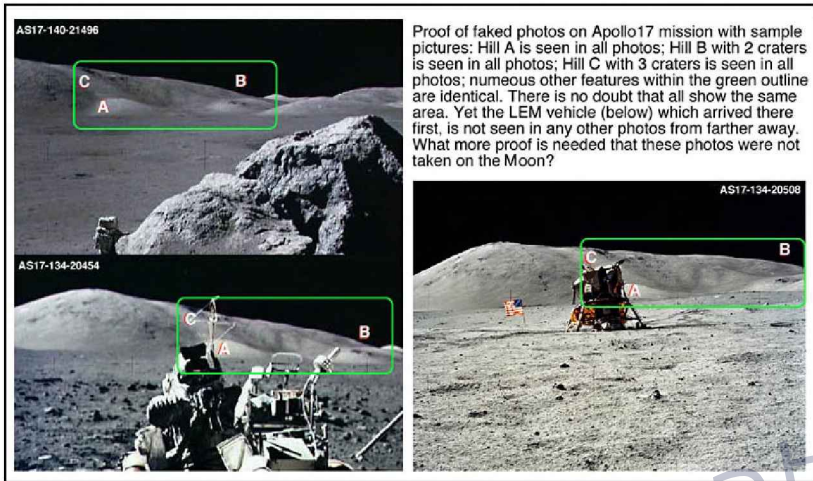

Figure 104: Annotations To NASA Photos by Jack White.

Jack White discovered that those who staged the Apollo 17 moon landing inadvertently placed lunar rover tracks around the LEM before the lunar rover was unpacked from the LEM.²³⁰

The Mystery of the Apollo Moonrovers: Chapter 1. Tracks while still packaged?



In 2002 I came across the photo at left. It seems to show the LRV rover vehicle still packaged, yet in the foreground are plainly seen rover tracks in the moon dust.



I thought that surely if the rover is still packaged, it could not have made tracks. The unopened package had been lowered from the starboard storage bay. The portside storage bay on the opposite side is still covered in gold foil. This photo and others appear to show that the LRV was assembled and outfitted at the left in this photo where all the footprints are. There are no such footprints on the opposite side. I decided to investigate further, because if my supposition were true, this was a smoking gun of fakery. So I searched among photos of other missions and found a similar photo, below, from Apollo 16 to compare with the one from Apollo 17 above. In this one the lowered package had been opened, the foil removed, and the rover had been assembled to the left of the opened package. It seemed I was on the right track.



I found the same with Apollo 15, package and rover on the right side.



Figure 105: Annotations by Jack White.

In a documentary film produce by NASA about the Apollo 16 moon mission, two videos, each allegedly taken from the moon,

were displayed and narrated. NASA claims that one video was taken from the moon showing John Young at the rim of a moon crater on April 21, 1972.²³¹ The NASA narrator explains that the astronauts traveled approximately one kilometer west of the LEM landing site to get to the moon crater where Young can be seen standing.²³² The NASA documentary explains that the next day, April 22, 1972, the astronauts traveled over 4 kilometers south of the landing site in the lunar rover and climbed up the side of Stone Mountain to a crater 700 feet in elevation above the LEM landing site. The two astronauts, John Young and Charles Duke, can be seen standing near the rim of the alleged moon crater.

When viewing the two videos, supposedly taken one day apart and many miles distance from one another, one can see clearly that the astronauts are in the exact same spot in both videos. The foreground is identical, right down to every rock and pebble. Not only is the location identical, but the shadows cast by the rocks are identical, which indicates that the location is being illuminated by an artificial, stationary light source. That is because, if the shadows were cast by the sun, the shadows would be of different lengths on different days. A lunar day is 30 Earth days long. Under the heliocentric model, the sun is thought to move in the lunar sky 12° in 24 hours. Further, the camera from which the two videos were taken was positioned at exactly the same location, and was shooting from precisely the same angle. This is clear evidence that the moon landings were videotaped from earth, using artificial lighting.

NASA has never explained the videos. Instead, it has tried to conceal the evidence. This author has searched the NASA website video library of the Apollo 16 moon mission for the original video footage used in the NASA Apollo 16 film documentary.²³³ The original videos of the two excursions discussed above are not posted on the NASA internet video library, which is supposed to contain a complete library of the Apollo 16 videos. Nonetheless, the two videos have been

represented by NASA to be genuine videos of the Apollo 16 moon mission.

Identical foreground, with identical shadows, videotaped from precisely the same distance, at precisely the same angle, portrayed by NASA to have been taken at two separate locations on two separate days on the moon.



Portrayed by NASA to be one kilometer west of the moon landing site on April 21, 1972.



Portrayed by NASA to be four kilometers south of the moon landing site on April 22, 1972.

The NASA space missions have been a hoax from the beginning. There is no such thing as the vacuum of space. In Genesis, it states that God made the firmament and he called the firmament Heaven. Genesis 1:7-19. The firmament, as the name suggests, is something hard. It is not a vacuum of nothingness. God set the sun, moon, and stars in the firmament of the heaven. The firmament divides the waters beneath the firmament on the earth from the waters above the firmament. Genesis 1:6-9. That is why the sky is blue; there is water above the firmament.

Proof of the NASA hoax is found in early photographs that were purported to be photographs of space missions. Researcher Ralph Rene uncovered a photograph of a fake space walk in an autobiography written by Apollo Astronaut Michael Collins, titled *Carrying The Fire*. Collins was the command module pilot aboard the Apollo 11 moon mission.

In Collins' book, he presented the two pictures (depicted below), separated in his book by almost 200 pages. The picture on the bottom left is a picture that was snapped by a professional NASA photographer aboard the zero gravity plane used by NASA. That airplane, nicknamed the vomit comet, flies in a parabola, which temporarily creates a weightless environment. Ralph Rene describes what is seen in the photograph.

The cabin is padded to protect the occupants from the inevitable fall the instant the loop is terminated. Here, Collins, as he practices space walking, is holding the propulsion rod in his right hand. Note the similarity between this picture and the one on the adjoining page [top-right below]. Note also that the suit's wrinkles deny that it is inflated.²³⁴

The other picture of Collins in the book, which is intended to represent Collins' purported space walk, is depicted on the top-

right and is described by Rene:

This picture was also extracted from *Carrying The Fire* and was allegedly taken during a space walk on the Gemini 10 mission exactly three years before his Apollo 11 mission to the Moon. NASA claims to have landed the first men on the Moon during this mission. He is shown holding a jet reaction propulsion rod with his left hand.²³⁵

Rene saw the two pictures in Collins' book and could not get over their similarities. He had a hunch.

Following an obvious hunch I had negatives made of both previous pictures. Then I had another negative made of the first photo reduced in size and flopped over. Collins is now practicing with his left hand, the same hand he used in his alleged space walk. I then had the "Gemini 10" picture blown up until the figure of Collins was the same size as this one.

I then rotated the blown-up photo clockwise until the propulsion rod made the same angle across the page on both pictures. Even the expression of his face is the same. Collins would have us believe that this picture was taken by a different person many months later. However, the negative of either picture placed over the print of the other produces a point to point coincidence until the binding line at the knee is reached. The missing area was removed when the photo was bound in his book.²³⁶

If I do the same to the original NASA picture #66-40127 (which took over 18 months to get

from NASA), the point to point coincidence continues to the soles of his boots. Why did NASA feel it necessary to fake pictures and lie to us as early as July 1966?²³⁷



Flipped Picture of Collins aboard the zero gravity training plane used by NASA



NASA flipped photograph in Collins' book purportedly taken During his Gemini 10 space walk



Picture of Collins aboard the zero gravity training plane used by NASA as it was depicted in Collins' book

The two pictures above compared side by side prove that they are not two different pictures, but rather the same picture. The purported space walk picture is actually the training picture that has been flipped and the background removed and replaced by the blackness of space to make it appear that Collins was in space. If Collins were actually in space, there would be no need to fake a photograph and falsely portray it as a space walk. The NASA space program is a government propaganda operation designed to convince the masses that the earth is a globe spinning in the vacuum of space as it orbits the sun.

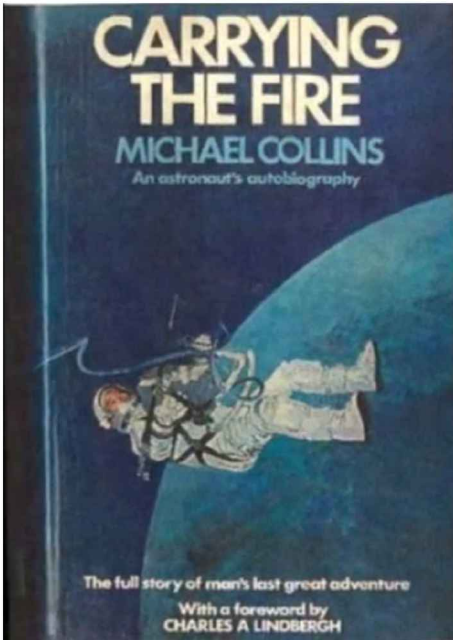

The pictures positioned on the top-left is the picture flipped by Rene. As you can see plainly, when comparing the Rene flipped picture with the NASA flipped picture, the two pictures of Collins are identical, except for the background. Collins put both the fake space walk picture and the training picture in his book. Collins obtained both pictures from NASA. Collins eschewed a ghostwriter for his book and proudly states in the foreword to the book:

“Above all, I am glad I wrote it myself.” Collins has been caught red-handed in a hoax. Those photographs are clear evidence that Collins was a knowing participant in the NASA space mission deceptions. Collins is the subject in both photographs. Why was it necessary to fake a space walk? Because Collins never went into space. Collins could not go to a place that does not exist.

So damning are the photographs in Collins’s book that NASA apologists have accused Ralph Rene of lying about the implications of the photograph.²³⁸ They argue that the photograph of Collins purporting to be in space appears without a caption, and, therefore, that Collins did not intend to convey that it was a



photograph of him in space.²³⁹

There are two problems with that argument. First, there is no other reason to alter the photograph by removing the training background and replacing it with a black space background other than to convey the impression that it is a genuine photograph of a space walk. The photograph in its altered condition could only be interpreted as depicting a genuine space walk. Collins' book was published in 1974, long before Photoshop or any other photo manipulating software came on the scene. To change the background on a photograph in 1974 required a graphic artist, with expertise in photo manipulation. NASA went through a lot of trouble, using 1974 technology, to remove the training background and replace it with a black sky. Why was it necessary to flip the training photograph when adding the black background? The only reason to flip the photograph is to obscure its origin as a training photograph. The only reason to obscure the space walk photograph's origin would be a desire to falsely portray the altered photograph as a genuine photograph of the alleged space walk by Collins.

The second problem is that the cover of the 1975 edition of Collins' book contains that same photograph showing him floating in space, with the earth in the background. Collins was clearly intending to convey that the photograph was a genuine depiction of his space walk.

The attitude of Collins in the cover photograph has been rotated to differentiate it from the training photograph. The cover photograph depicts the earth in the background; Collins was using the training picture on his cover to falsely portray it as a picture of his space walk. When the picture on the cover is rotated, we see that it is the unflipped training photograph. Collins used a training photograph not once, but twice, to falsely portray it as a picture of his alleged space walk. The photograph on the cover and the space walk photograph in the book are one and the same. There is one

difference between the space walk photograph on the cover and the space walk photograph inside the book. The photograph on the cover is not flipped. However, both have the same origin and objective; they are both false portrayals of a space walk through the use of what is, in reality, only a training photograph.

NASA knew before the Gemini 10 mission launched that it was not going into space. They knew that there was no space within which to conduct a space walk. That is the principal reason for the photograph of Collins' NASA training in the vomit comet. Why else would NASA send a photographer to take pictures during a routine training exercise? Why was it necessary for Collins to wear his entire space suit simply to train for a weightless environment? Why take the chance of damaging that space suit during training? It is obvious; the vomit comet ride, with Collins wearing his full space suit, was intended as a photo session. The plan all along was to doctor the photo to falsely represent a space walk by Collins.

Collins and NASA could not allow the damning photographic evidence discovered by Rene to continue to float around (no pun intended). Once the issue came to the fore, Collins revised the book to remove the moon walk picture with the black background.²⁴⁰ The fact that Collins redacted that photograph from the later editions of his book speaks volumes. He could have kept the photograph in the book and simply explained its real meaning. Instead, he removed it. Why? Because there is no innocent explanation. If there were some innocent explanation, then Collins would simply have explained the photograph in the later editions.

To add insult to injury, the fake hero Collins hoodwinked a genuine hero, Charles A. Lindbergh, to write the foreword to his book. Collins knows no shame.

The reason that NASA found it necessary to fake pictures and videos is because there is no vacuum of space. The earth is

encompassed by a firmament, exactly as the bible states. The myth of the limitless vacuum of space, suggests that there is no heaven. If there is no heaven, which is the abode of God, that in turn suggests that there is no God. If there is only an empty vacuum of space, that refutes God's word that states that God is walking above us in the circuit of heaven. "Thick clouds are a covering to him, that he seeth not; and he walketh in the circuit of heaven." (Job 22:14)

During the Apollo 17 moon mission the sound of impact could be clearly heard when an astronaut was seen hitting something with a hammer.²⁴¹ The fact that the sound of the hammer hitting the object could be heard meant that the astronauts were not in a vacuum. In the supposed vacuum of space, sound cannot travel. Sound waves need medium, such the atmosphere found on earth, through which to travel. If the astronauts were truly in the vacuum of space on the moon, the sound of impact should not have been heard. The same phenomenon was heard during the Apollo 15 moon mission, when an astronaut threw an object at the LEM and it hit with an audible thud.²⁴²

Indeed, the space travel to the moon was premised on using rockets in the vacuum of space. Anyone with a rudimentary knowledge of physics knows that rockets require a fulcrum to push against to move.²⁴³ On the earth the fulcrum is initially the ground, and after liftoff the fulcrum is the atmosphere. Space is supposed to be an empty vacuum. In a vacuum, there is nothing to act as a fulcrum for a rocket to push against. A rocket in the vacuum of space would be useless.

The space station is another hoax. All supposed photographs of the space station are taken in a large underwater tank in order to simulate the fiction of weightless space. Indeed, NASA and space agencies from other countries have been caught faking space walks. There are numerous official videos from various countries' space agencies where bubbles can be seen rising

from trapped air during purported space walks.

In 2013, it was revealed that an astronaut nearly drowned while he was supposedly in space. I kid you not. How is it possible to drown in the vacuum of space? NASA has since retrofitted space suits with snorkels. Fox News reported:

After a spacewalking astronaut nearly drowned in his helmet in July, NASA has a plan to protect its crew when they venture into the vacuum of space this weekend: snorkels and absorbent towels. ... “Some smart engineers on the ground said, hey, this looks like a snorkel you’d use for scuba diving,” explained Allison Bolinger, NASA’s lead U.S. spacewalk officer.²⁴⁴

Indeed, in one official NASA video of the International Space Station, Steve Blakey discovered a diver moving around wearing an underwater scuba tank.²⁴⁵ There is no purpose for a scuba tank in space, but there is a real need for a scuba tank underwater, which is where the International Space Station is really located.

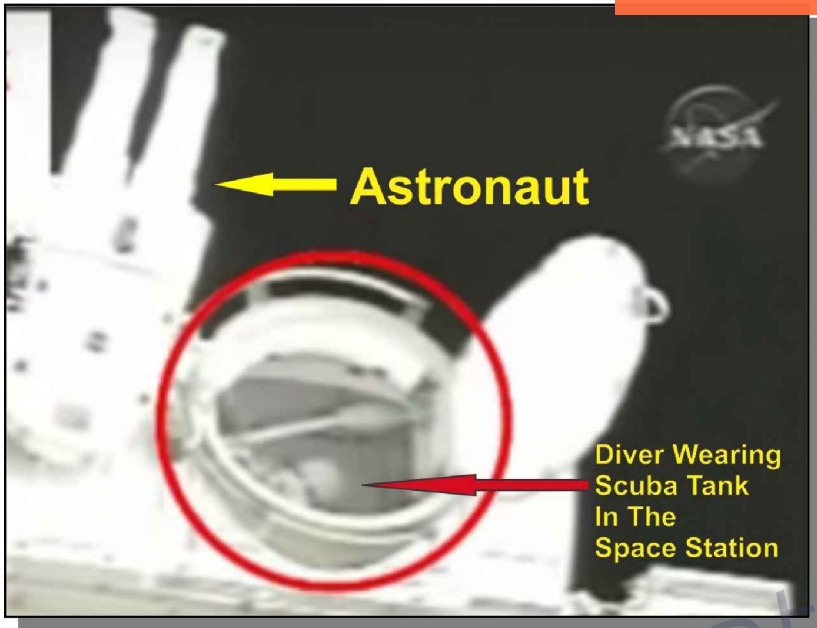

What about the hundreds of pounds of moon rocks brought back from the moon? Surely that is hard evidence that NASA went to the moon; isn't it? Not really. The rocks purported to be moon rocks are simply rocks from Earth that are used as moon rock props. One example is the fake moon rock presented to the former Prime Minister of the Netherlands, Willem Drees Jr., by the U.S. Ambassador to the Netherlands, J. William Middendorf II, on October 9, 1969. The rock was presented on the occasion of the visit to the Netherlands of the Apollo 11 astronauts, Armstrong, Collins, and Aldrin.²⁴⁶

When Drees died in 1988, the moon rock he received from the U.S. Ambassador was donated to the Dutch Rijksmuseum, which is the national museum of the Netherlands. The Rijksmuseum vetted the authenticity of the moon rock by contacting NASA directly. NASA confirmed that the moon rock was genuine. According to a museum spokesman, Ms. Van Gelder, no one doubted the authenticity of the rock, because it was

donated by the prime minister, who received it from the U.S. Ambassador, accompanied by the astronauts who retrieved the rock from the moon. Furthermore, its authenticity was confirmed by NASA. The Rijksmuseum was so confident of its authenticity that it insured the rock for a half million dollars.

In 2009, researchers from the Free University of Amsterdam tested the moon rock and determined that it was not from the moon. How could they tell that it was not from the moon? Because they were able to determine that it was, in fact, petrified wood. The researchers were pretty sure that there are no trees on the moon.

From where did the U.S. Ambassador get the rock? Directly from NASA. The ambassador was the official representative of the U.S. Government accompanying the Apollo 11 astronauts during their goodwill trip to the Netherlands. The astronauts, who claimed that they obtained the rock from the moon, brought the moon rock with them. That means that the fake moon rock had a chain of custody directly from NASA to the U.S. Ambassador to the Netherlands, to a former Prime Minister of the Netherlands, then to the national museum of the Netherlands. NASA subsequently vouched for the rock's authenticity after the museum received it, but it turned out to be a fake moon rock. The ineluctable conclusion is that NASA was distributing fake moon rocks.

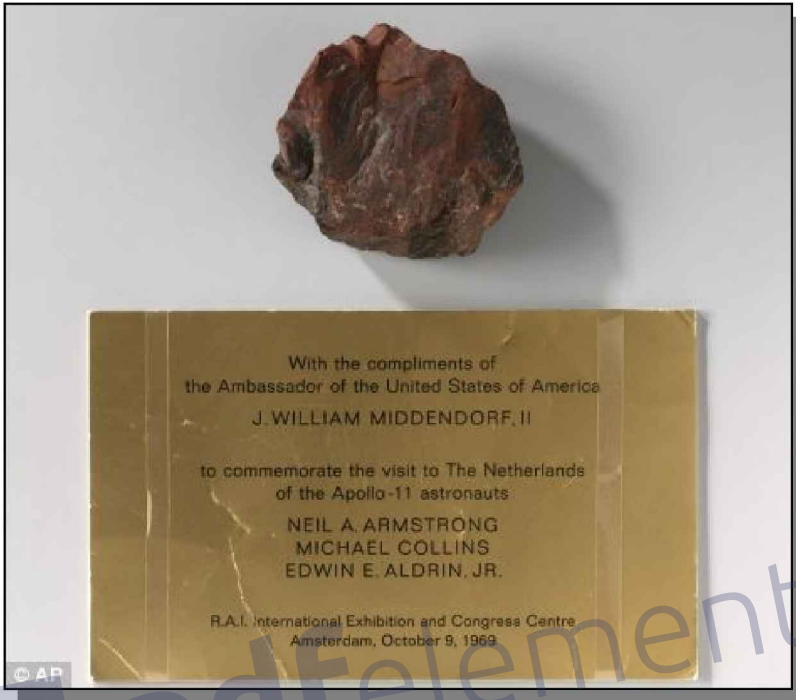

Figure 111: Associated Press picture of the fake moon rock from NASA, presented to the former Prime Minister of the Netherlands by the U.S. Ambassador.

Not surprisingly, “U.S. embassy officials were unable to explain the findings, but are investigating.”²⁴⁷ As of this writing it has been over six years since the U.S. Government has promised to investigate the moon rock fraud. There have been no findings announced since that time. When the U.S. Government promises to find the cause for the fraudulent moon rock that came from NASA and after six years does not announce any findings, that suggests that the U.S. Government is the culprit. NASA is the source for the fraudulent moon rock.

The U.S. Ambassador is the official representative of the U.S. Government in a foreign country. The U.S. Government will

never explain how they presented a fake moon rock as a gift to a foreign government official, because to do so would require it to admit that all moon rocks are fake. NASA never went to the moon, and the fake moon rock, which was vetted through and authenticated by NASA and came directly from the Official U.S. Government representative in the Netherlands, is yet one more piece of evidence proving that the NASA moon landings were hoaxes. NASA was handing out fake moon rocks, because they have no real moon rocks to give out. They have no real moon rocks, because they never landed on the moon.

The fake moon rock presented to former Prime Minister Drees was not the only moon rock gifted to the Netherlands when the astronauts visited on October 9, 1969. A news account of the visit by the Apollo 11 astronauts to the Netherlands, appearing in the October 9, 1969, edition of *Nieuwsblad van het Noorden*, states that the astronauts paid a lightning visit to the Netherlands; they arrived in the Netherlands at 10:00 a.m. and departed at 3:00 p.m. It almost seems that their only purpose in making the trip to the Netherlands was to distribute moon rocks and then get out of town. The news account bears a picture of the three astronauts meeting with Queen Juliana, Prince Bernard, and Prince Claus and presenting the Queen with gifts. The most significant gift presented to the Queen was a moon rock.

The article states that “when the astronauts arrived at the palace, the Queen received a replica of the message the astronauts left on the moon and a piece of moon rock.”²⁴⁸ That moon rock was one of a group of moon rocks, which included the fake moon rock presented to former Prime Minister Drees. The Queen’s moon rock was never tested for authenticity, because after the moon rock given to Prime Minister Drees was found to be fake, the Queen’s moon rock was found to have disappeared.²⁴⁹

ASTRONAUTEN BIJ KONINGIN



October 9, 1969, news article appearing in *Nieuwsblad van het Noorden*, with a picture documenting the Apollo 11 astronauts' meeting with Queen Juliana of the Netherlands, at which time they gave her two gifts, one of which was a moon rock. Left to right in the picture: Queen Juliana, Prince Bernard, Collins, Aldrin, Armstrong, and Prince Claus. The last sentence of the article, translated into English, states: "When the astronauts arrived at the palace, the Queen received a replica of the message the astronauts left on the moon and a piece of moon rock." A similar moon rock, which was given to the former Dutch Prime Minister during the astronauts' visit that day, was determined in 2009 to be fake; it proved to be petrified wood. The moon rock given to the queen, conveniently "disappeared" before it too could be proven to be fake.

De Amerikaanse astronauten Neil Armstrong, Michael Collins en Edwin Aldrin hebben vandaag een bliksembezoek aan ons land gebracht. Om tien uur landden ze op Schiphol (met een der vliegtuigen van president Nixon) en om drie uur vanmiddag vertrokken ze weer. In deze paar uren zijn ze op het koninklijk paleis op de Dam in Amsterdam ontvangen door de Koningin en in een rondvaartboot naar het RAI-congrescentrum gevaren, waar zij voor 1400 genodigden een film van hun maanreis vertoonden, en de tentoonstelling „Maanvaart '69" openden. Bij de ontvangst in het paleis kreeg de Koningin een replica van de boodschappen die de astronauten op de maan achterlieten en een stukje maansteen.

U.S. Ambassador to the Netherlands J. William Middendorf II presented yet a third moon rock to Prince Bernhard of the Netherlands in late 1969 or early 1970. That moon rock, reportedly weighing 34.1 grams, could not so easily be made to disappear, because it was put on display in the Dutch Museum in Leiden.²⁵⁰ Museums are known for their tight security, and therefore it would be much more difficult for that moon rock to

“disappear.” There has not been any public announcement of Prince Bernhard’s moon rock having been tested, nor is any announcement likely. The embarrassment of the exposure of the fraudulent moon rock given to former Prime Minister Drees was enough for NASA; certainly, immediate diplomatic efforts were made to prevent any further public revelations that would give away the deception and expose the NASA moon landings as elaborate hoaxes.

Mary Bennett and David Percy in their book, *Dark Moon*, recount an interview that led Paul Jacobs to believe that high officials in the Federal Government knew that the moon rocks were fake and were privy to the moon landing hoax.

A few months before his untimely death in 1978, the well known American investigative journalist Paul Jacobs interviewed the Head of the US Geological Survey Department in Washington, D.C. Jacobs asked him for his views on the moon landings in general and the lunar rock samples in particular. When he reported his interview to [Bill] Kaysing, Jacobs said that he received some very cryptic answers. The geologist had assured him that the rocks were real. But when Paul Jacobs said: “If they weren’t real and you were in on the hoax, you would still attest to their reality wouldn’t you?”—the geologist just smiled.²⁵¹

In a Fox Network documentary, former astronaut Brian O’Leary stated:

Regarding the Apollo missions, I can’t say 100% for sure whether these men walked on the moon ... It’s possible that NASA could have covered it up, just in order to cut corners and be the first to allegedly go to the moon.”²⁵²

O'Leary was not just any astronaut; he was a NASA astronaut in the 1960s and served as a science advisor during the Apollo moon missions. He worked closely with the purported moon landing astronauts, including Neil Armstrong, Buzz Aldrin, and Michael Collins.

NASA simply could not allow an Apollo astronaut postulating that the moon missions could have been hoaxed. One can imagine that after O'Leary made his statement, he had an official visit from NASA, where he was given counseling in no uncertain terms. O'Leary subsequently clarified his statement made during the Fox documentary. O'Leary stated that "somehow I may have given the impression that Apollo may have been hoaxed,"²⁵³ but that he in fact believes that NASA did go to the moon. O'Leary said that "it was real ... Apollo happened."²⁵⁴

O'Leary claimed that the Fox producers used quotes from him taken out of context to suggest that O'Leary had serious doubts about the legitimacy of the moon landings. The problem with O'Leary's claim is that he is seen in a video interview saying the very words quoted above. He never explained how his words were taken out of context. Indeed, in a later interview, O'Leary suggests that he in fact meant what he said during the Fox documentary:

O'Leary was initially skeptical when his astronaut friends who continued in the program and flew the lunar landing missions gave abbreviated answers to his questions. But he is quick to add that they may just have been sick of being asked so many questions upon their return. And he is sick himself of being asked about his position on the Apollo hoax; when contacted in March 2009 to confirm our quotes, O'Leary said this interview was his last public word on the subject.²⁵⁵

If one reads carefully O'Leary's above statement, he essentially admits that he was "initially skeptical" of the legitimacy of the moon landings. That suggests that he meant what he said during the Fox documentary. When O'Leary said on camera that he could not say with certainty that the Apollo astronauts walked on the moon and that it was possible that NASA covered up the fact they did not do so, he said it, because he believed it. It seems that the producers of the Fox documentary did not twist his words. O'Leary was in fact skeptical of the moon landings, just as he said on camera. O'Leary meant what he said.

The most that can be said about his retraction is that he subsequently changed his mind, and he came to believe that the moon landings were real. The problem with that explanation is that he was an astronaut in the 1960s. He was a science advisor to the NASA Apollo missions at that time. For over 30 years he believed that the Moon landings may have been hoaxed. Suddenly, after his private beliefs, which he held for over 30 years, become public via a network news documentary, he suspiciously changes his mind and announces that the moon landings were real after all.

O'Leary later stated that if there had been a moon landing hoax, he would have known about it, because the astronauts who were in on it would have told him.²⁵⁶ That is something, however, that he had in mind for the entire 30 years that he doubted the authenticity of the moon landings. How could it suddenly be the basis for him changing his mind to believe the moon landings were real? His explanation does not pass the smell test. His explanation cannot be the reason that he went from being a doubter to believing "it was real ... Apollo happened."²⁵⁷

O'Leary was being deceptive when he claimed that if the moon landings were a hoax, he believed that the participating astronauts would have told him. O'Leary's statement, that the moon landing astronauts would have told him about it being a hoax, is impeached by O'Leary's other statement that the

astronauts who flew the alleged lunar landing missions did not open up to him about the missions, but “gave abbreviated answers” to his questions, seemingly to make him go away. The inference he drew was that the astronauts were being cryptically short with him, because they were holding back the fact that the moon landings were a hoax. He gave that as one of the reasons he initially doubted the authenticity of the moon landings in the first place.

Brian O’Leary’s claim that the moon landing astronauts would have told him if the Apollo missions were faked is incredible for yet another reason. He was fully aware that all astronauts know what would happen to them if they were to let that secret out. For example, Gus Grissom was very public about his view that the chances were slim of NASA meeting the Apollo mission requirements.²⁵⁸ Shortly before Grissom died, he hung a large lemon on the Apollo space capsule as the press looked on, thus graphically indicating his opinion of the space capsule. Grissom, along with fellow astronauts Ed White and Roger Chaffee, was shortly thereafter immolated inside a test capsule when it burst into flames as it sat on the launch pad during a test. During the test, and before the fire, there was a communication failure. Grissom is recorded saying at that time: “How are we going to get to the moon when we can’t communicate between two buildings?”²⁵⁹

Grissom’s opinion that the Apollo mission was doomed to failure was based upon his close study and examination of the mission rocket and other equipment. He took detailed notes and wrote reports about his findings. The day Grissom died on the launch pad, FBI Agents burst into Grissom’s home and seized all of his records. Grissom’s wife reports that those records were never returned.²⁶⁰ The fire on the launch pad took place on 27 January 1967, at 6:30 p.m.²⁶¹ The FBI search took place in the evening of January 27th, immediately after Grissom died. Someone was at the ready to give the order to conduct the search

as soon as it was determined that Grissom was dead. That suggests governmental foreknowledge of the launch pad fire.

Christopher Ruddy of NewsMax revealed that before his death, Grissom had received death threats, which his family believed emanated from within the space program.²⁶² The threats were viewed as so serious that Grissom was put under Secret Service protection and had been moved from his home to a secure safe house. Grissom's wife states that Grissom told her that "if there is ever a serious accident in the space program, it's likely to be me."²⁶³

Prior to the Apollo 1 capsule disaster, an inspection official, Thomas Baron, wrote a 500 page report that documented mismanagement and incompetence at NASA's Pad 34, where the Apollo 1 disaster took place. Thomas Baron testified before Congress regarding the deaths of Grissom, White, and Chaffee, and gave critical testimony about improper actions and irregularities at NASA.²⁶⁴

NASA tried to discredit Baron's testimony before Congress, but to no avail. Baron was a meticulous investigator, and he had the documented evidence. One example of NASA's effort to discredit Baron happened after Baron testified to an interview he conducted with Marvin Holmburg, who told him that the astronauts, apparently sensing the danger they were in, tried to get out of the capsule five minutes before the capsule burst into flames.²⁶⁵ NASA apparently persuaded Holmburg that his revelation to Baron was imprudent. When Holmburg was called to testify before Congress, he suddenly changed his story and denied that he ever told Baron that the astronauts tried to get out of the capsule.²⁶⁶

Baron's 500 page report mysteriously disappeared, and to this day it has never been found. NASA failed to discredit Baron before Congress, and they could not allow him to repeat what he

knew to the press. All criminal organizations know that dead men tell no tales. Within a week after his Congressional testimony, Baron, his wife, and his stepdaughter were killed, when his car allegedly stalled at a railroad crossing and was struck by a train.²⁶⁷ Contrary to Florida law, no autopsy was performed. All three bodies were quickly cremated, thus ensuring that any foul play would not be discovered.²⁶⁸

A little known fact about the pressure test of the capsule in which Grissom, White, and Chaffee were participating, was that the capsule that was being pressure tested was obsolete at the time it was tested. It was never in the plans to ever be used again for a NASA launch.²⁶⁹ It was, therefore, not very useful for a pressure test. The capsule, however, made the perfect inescapable oxygen bomb.

It seems that the capsule was modified to make it impossible for the astronauts to free themselves from the capsule if something went awry during the test. In his book, *NASA Mooned America*, Ralph Rene explained:

Also, was it really the vicissitudes of life that the outward opening hatch was coincidentally changed that very morning to one that opened inward? An inward-opening hatch meant that any inside pressure, acting outward, would prevent it from being opened — even if someone was standing by, which they weren't. It was also bolted up from the outside and lacked explosive bolts.²⁷⁰

Another suspicious fact is that NASA decided to use pure oxygen to pressure test the obsolete capsule. It was completely unnecessary to use pure oxygen to run a pressure test. Pure oxygen is very dangerous, even at ordinary pressure. Steel wool will burn in pure oxygen. In one case, Rene explained that “an asbestos

blanket, normally classed as fireproof, was consumed when used to smother flames during an oxygen fire.”²⁷¹ Any hydrocarbon can burst into flames with the smallest spark or even a slight increase in heat in a pure oxygen environment. Oily rags have been known to spontaneously burst into flames in a pure oxygen environment.

Between 1962 and 1967 the Federal Government had no less than seven (7) explosive fires occur at various facilities while using pure oxygen. The NASA engineers knew full well the danger in which they were putting Grissom, White, and Chaffee. NASA had previously commissioned a report by Dr. Emanuel M. Roth, which was published in 1964. Rene states that “Dr. Roth cited difficulties with 100 percent oxygen atmospheres even under low pressures. Any competent engineer should have known the dangers of oxygen at 16.7 or 20.2 psi [the pressure of the oxygen in the capsule Grissom, White, and Chaffee were in].”²⁷²

Rene further stated that “[t]his is why I cannot believe that this was ‘standard operating procedure’ or that Grissom and his crew knew about it. NASA not only ignored their own tests on pure low-pressure oxygen but upped the ante by increasing the pressure above atmospheric! [Erlend] Kennan and [Edmund] Harvey had this to say, ‘Most U.S. scientists could not believe their ears when they learned that fact. Oxygen at such pressure comes in the category of an oxygen bomb.’”²⁷³

Rene revealed one example of the dangerousness of oxygen that resulted in two men being killed at a U.S. Government facility. A terrible accident took place on January 1, 1967, approximately three weeks before Grissom, Chaffee, and White were burned to death. “Two men were handling 16 rabbits in a chamber of 100% oxygen at 7.2 psi at Brooks Air Force Base and all living things died in the inferno. The cause may have been as simple as a static discharge from the rabbits fur ... but we’ll never know.”²⁷⁴ That accident was at 7.2 psi. The pressure in the capsule that Grissom, White, and Chaffee were in was cranked up to

between 16.7 and 20.2 psi.

Experts call pure oxygen put under pressure “oxygen bombs” because pure oxygen is exponentially more dangerous when put under pressure. When under pressure, combustible materials can spontaneously explode into flames because of the heat generated by rapid oxidation. The obsolete space capsule that was being tested by Grissom, White, and Chaffee was full of combustible materials. At a pressure between 16.7 and 20.2 psi any spark would cause the oxygen to explode and immediately immolate any living thing in the capsule, just as happened.

Grissom smelled a rat prior to the pressure test. The dangerous test just did not make sense to him. Ralph Rene explains:

Wouldn't you have smelled a rat? Perhaps Grissom was a bit worried. He got Wally Schirra to ask Joe Shea, NASA's chief administrator, to go through the test with him. “Grissom still wanted Shea to be with him in the spacecraft.” Shea refused because NASA couldn't patch in a fourth headset in time for the test. Is that likely? It is difficult to believe that this couldn't have been done in the 24-hour time frame available. If I had a crew of technicians who couldn't install another headset jack in that amount of time I'd fire the whole damn crew.²⁷⁵

Ralph Rene opined the following: “I also feel that spontaneous combustion would have been much too subtle for the CIA. If it was a CIA hit they would have done it with an electric squib or incendiary device wired to a switch, programmed to be thrown toward the end of the test.”²⁷⁶

Rene's opinion of the method used to murder Grissom,

White, and Chaffee turned out to be correct. Gus Grissom's son, Scott Grissom, for years believed that his father was murdered. He, however, was unable to prove it until 1990, when he was granted access to the Apollo 1 space capsule that exploded in flames killing his father. Scott Grissom discovered a mechanism in the space capsule purposely placed there to create a spark and cause the oxygen rich capsule to explode into flames. Amy Shira Teitel reported for *Discovery News*:

The younger [Scott] Grissom had his suspicions in the 1960s but wasn't able to prove foul play until the 1990s when he was granted access to the charred Apollo 1 capsule. Rooting around the instrumentation, he found a "fabricated metal plate" behind a switch on one of the instrument panels that controlled the source of the capsule's electrical power. Its placement behind that switch, he said, was clearly an act of sabotage. It ensured that when any crew member toggled that switch there would be a spark. That spark would have been enough to start the fire that killed the crew.

A McDonnell-Douglas engineer, Clark MacDonald, backed Scott Grissom's story. In his own accident investigation he identified an electrical short brought on by a changeover to battery power as the reason for the fire. But NASA destroyed his report, he said.²⁷⁷

Clark MacDonald, during a later news interview, opened up about how his conscience bothered him regarding what he knew to be evidence of the murder of the three astronauts:

"I have agonized for 31 years about revealing the truth but I didn't want to hurt NASA's image or

cause trouble," MacDonald told the paper. "But I can't let one more day go by without the truth being known."²⁷⁸

Ralph Rene explains just a part of the coverup by NASA after the disaster.

[Frank] Borman played dumb when he was called before Congress. In testifying under oath he said, "None of us were fully aware of the hazard that existed when you combine a pure oxygen atmosphere with the extensive distribution of combustible materials and a likely source of ignition ... and so this test ... was not classified as hazardous." And if Borman was as unaware of all the dangerous fires that erupted during NASA's own safety tests over the years, why did he later write about 20.2 psi oxygen in this manner: "That is an extremely dangerous environment, the equivalent of sitting on a live bomb, waiting for someone to light the fuse."²⁷⁹

Borman held a master's degree in engineering and taught thermodynamics at West Point, and yet he claims that neither he nor any of the eminent engineers at NASA understood the dangers of a pressurized oxygen capsule. That is pure malarkey! NASA had to silence Grissom, who was an independent thinker and a threat to blow the whistle on NASA's moon landing hoax. Grissom, White, and Chaffee were literally sitting inside an oxygen bomb rigged by NASA to explode and silence a troublesome whistle blower.

James Irwin, the Apollo 15 Command Module Pilot, by the grace of God, became a Christian and was giving his Christian testimony in Nashville, Tennessee. At that time, he met a fellow Christian, Lee Gelvani, who had almost convinced James Irwin,

to confess to the moon landing hoax. Irwin suspiciously died the day before he was expected to confess to the hoax.

In the days before his death, Irwin called Bill Kaysing on the telephone. Kaysing, at that time, had written the best known book about the moon landing hoax.²⁸⁰ Irwin stated during the call that he was concerned that the phone he was using was tapped. He gave Kaysing his home phone number, and asked him to call him back that coming Friday at his home in Colorado Springs, Colorado. When Kaysing called him as scheduled that Friday, Kaysing found out that Irwin had died of a heart attack.²⁸¹ James Irwin died on Thursday, August 8, 1991, the day before Kaysing was scheduled to call him. Irwin knew that his phone calls were tapped, which speaks volumes about the kind of pervasive surveillance the astronauts are under. While there is no explicit proof that Irwin was murdered, his sudden death the day before he was expected to confess to the moon landing hoax is certainly suspicious.

Between the years 1964 and 1967, a total of 10 astronauts died in freak accidents. Those deaths accounted for fully 15% of NASA's astronaut corps.²⁸² O'Leary would have us believe that the Apollo astronauts who were portrayed as going to the moon would have told him about a hoax, if there had been one. The astronauts are not known to be slow learners. The deaths of Grissom, White, and Chaffee, along with the other astronauts offered stark object lessons for the moon landing astronauts to keep the hoax a secret. Indeed, it is likely those object lessons served to motivate O'Leary to retract his publicly expressed doubts about the authenticity of the moon landings.

In 2004, President George W. Bush announced plans to return to the moon. In his formal space exploration address, he stated the obvious pathetic state of the current space exploration achievements since the U.S. purportedly last went to the moon. "In the past 30 years, no human being has set foot on another world or

ventured farther up into space than 386 miles, roughly the distance from Washington, D.C., to Boston, Massachusetts.”²⁸³

President Bush said that NASA would start with unmanned missions. “Beginning no later than 2008, we will send a series of robotic missions to the lunar surface to research and prepare for future human exploration.”²⁸⁴ Bush planned for the first manned mission to the moon in 2015.

2015 has come and gone, and there has been no NASA manned moon mission. Why not? It would seem easy enough. Just dust off the old Apollo program plans and start right up again. The rockets and landers supposedly worked perfectly on six separate moon missions 40 years ago, with much older technology. Going back to the moon, with today’s technology, should be a piece of cake.

It seems that NASA cannot replicate the Apollo missions and is therefore forced to go back to the drawing board. Why? One reason is that NASA and its contractors allegedly lost the plans for the Lunar Excursion Module (LEM) and the Lunar Rover. They also claim that they lost the plans for the huge engines that powered the Apollo space craft.²⁸⁵ When there are allegations that an event was faked, and evidence that could prove that it actually happened disappears while it is in the possession of the perpetrators of the alleged fraud, the only reasonable conclusion is that the missing evidence would prove the fraud.

Obviously, the plans were made to disappear, because those plans would reveal the impossibility of landing on the moon. NASA and their contractors would rather appear to be incompetent knuckleheads, than be indicted for criminal fraud, so they just “lost” the plans that could prove the fraud.

NASA is good at taking great studio photographs of the astronauts and producing elaborate patches to memorialize its

missions for posterity. However, it can't seem to maintain the really important records of its alleged achievements. Aaron Ranen discovered during production of his documentary of the Apollo moon missions that all of the audio tapes from the Apollo missions have also disappeared.²⁸⁶

In addition, the telemetry videotapes of the alleged Apollo 11 moon landings have all been erased.²⁸⁷ All 45 videotapes were erased. The only tapes remaining are old second source television network recordings. The official report from NASA states:

The 45 Apollo 11 tapes were degaussed, recertified, and reused to satisfy a NASA-wide shortage of one-inch tapes more than a decade later. NASA's M-22 recordings of the Apollo 11 moonwalk likely were gone forever.²⁸⁸

NASA would have people believe that the original videotapes of the Apollo 11 historic landing on the moon were taped over, because their need for blank videotapes overrode the importance of the moon mission tapes. NASA argued that nobody from NASA understood the historic significance of the tapes and simply taped over them. People preserve their family pictures and videos of vacations, because they are records of memorable events. The Apollo 11 moon mission was a monumental historic achievement; everyone at NASA certainly understood that fact. Why didn't NASA do what ordinary people do and buy more videotape? Erasing the moon landing mission tapes would be like using the Declaration of Independence as packing paper and arguing that once we won our independence, we didn't need that old thing anyway; we might as well get some use out of it.

Why did NASA find it necessary to destroy the telemetry videotapes? Because the heads of NASA realized that many of the tapes contain footage that would reveal the hoax. They learned their lesson in 2001, when Bart Sibrel got his hands on a NASA

videotape that showed the Apollo 11 astronauts faking the pictures of Earth, by using some sort of transparency against the cabin window. Sibrel included that tape in his 2001 documentary movie, *A Funny Thing Happened on the Way to the Moon*, to the great embarrassment of NASA. NASA realized that it could not allow a repeat of that leak, and so it made certain that all remaining videotapes disappeared. The tape erase story is simply the cover story for the deliberate destruction of incriminating evidence.

One might think all is not lost, NASA still has the original video tapes of all of the other moon landing missions. However, that is not so. It seems that NASA has been busy destroying tapes. Bart Sibrel gives a rundown of the further efforts of NASA to destroy records of the mythical moon landings.

Not only are all of the specifications, blueprints, and telemetry data of the miraculous NASA 1960's technology that allegedly went to the moon on the first attempt nowhere to be found, all of the original television transmission videotapes, estimated to weigh about two tons, have also been mysteriously "misplaced" inside the Federally Secured National Archives! Why? Because naïve director Ron Howard, whose own wise grandfather warned him that the moon landings were staged, requested that all of the original videotapes be transferred to High Definition for an I-Max documentary he was producing to commemorate the "moon" missions. Prior to this, the highest quality version of the original footage that anyone had ever seen was deliberately fourth generation (a copy of a copy of a copy of a copy), in order to disguise the falsification detail of the fake "moon" landscapes.

When this moon landing believing prominent film director asked for the original NASA videotapes of all of the “moon walks” to be transferred to High Definition in order to be projected onto a screen that was nearly 120 feet by 100 feet for the first time in history, for all the world to see at a resolution that was at least four times greater in detail than had ever before been witnessed, within days of his request, all of the original videotapes vanished from the Federal Archives!!! But of course, we still went to the moon, right?

Proof of this, is that when Howard’s documentary commemorating the “moon” landings was finally produced without this essential material, he resorted to filling about 95 percent of the gap with “reenactments” of the “moon walks,” which he likewise filmed in a television studio. In fact, there was so little actual footage available of the alleged greatest event of the 20th century, that this multimillion dollar director had to resort to renting VHS tapes of other filmmakers’ previous work at Blockbuster Video in order to have at least some of the vanishing NASA footage! He was so ashamed of the low quality of the images he was forced to use because of the scarcity of them, that he reduced their size within the nearly 120 foot by 100 foot screen to only about 10 percent of the available space.

In case you were wondering “what if”, someday, the mysteriously vanished original videotapes were to one day be found? . . . Oops! . . . Did I forget to tell you? . . . The only machine on the entire planet that could ever play these one of a

kind format videotapes was deliberately disassembled and destroyed by NASA, right after the originals got “misplaced”, making that scenario absolutely impossible!²⁸⁹

Incidentally, Ron Howard engaged in a limited hangout of the truth of the Apollo 11 moon landing hoax during a video is a clip from a season four episode of “Arrested Development” entitled “The B. Team,” which aired in 2013 on Netflix. Howard was the executive producer of that show. In one scene, Ron Howard plays himself and has a conversation with the character played by Jason Bateman.

Howard: Hey, let's go inside the LEM, do you want to?

[Both Howard and Bateman walk over to where the LEM is situated in the studio office area.]

Bateman: Wow is this the one that landing on the moon?

Howard: On a sound stage.

Bateman: Oh from Apollo 13?

Howard: No from 1969. I'll tell you about it inside the LEM. It's sound proof in there. And it's a national secret. So, NASA did go to the moon in '71. That one was real. But in '69, they weren't ready. So they faked the whole thing on the sound stage of Gentle Ben. Me and my brother, we hid up in rafters, we seen the whole thing.²⁹⁰

The monologue by Howard takes place inside a mock-up of the LEM that is set up in his studio offices. The whole purpose

of the vignette is to assure the listeners that “NASA did go to the moon in ‘71.” Ron Howard’s monologue is an example of exposing part of a conspiracy in order to spin the facts to persuade people to believe a the big lie that the earth is a sphere floating in the vacuum of space. Before Howard admits that NASA faked the moon landings in 1969, he reassures Batemen (and the listening audience) that they did in fact go to the moon in 1971. Howard attributes an innocent reason for faking the moon landing on a sound stage; NASA wasn’t ready. That acknowledgment by Howard admits facts that are becoming increasingly clear to the public anyway. However, in order to keep the lie of a spherical earth floating around the sun in the vacuum of space, Howard dampens the revelation by reassuring the listening audience that NASA did in fact go to the moon in 1971. He prefaces his monologue with the statement “NASA did go to the moon in ‘71. That one was real.” That is the primary message that with which the audience is intended to be left.

The revelation of the fake moon landing by Howard is done in the context of a situation comedy TV show, so it can be easily dismissed. However, be mindful that Howard was the executive producer of the show and therefore had complete control over the script. Making the revelation during a TV show is the perfect way in which to spin the evidence of the moon hoax. Howard is able to reinforce the myth of the earth floating in the vacuum of space, and his statement that the Apollo 11 moon landing was faked was not an official pronouncement by an insider but rather part of a cameo appearance in a situation comedy TV show. In order to make the moon landing hoax admission seem unbelievable, Howard adds the incredible fact that he and his brother hid up in the studio rafters and saw its filming. It is the perfect set up for a limited hangout, where the truth is mixed with lies. His admission in the context of a TV show that the Apollo 11 moon landing was hoaxed was done to establish that the other moon landings that followed were real. That context allows Howard, who has inside information, to make what is essentially

a non-admission/admission. Thus the myth of the vacuum of outer space is reinforced.

 pdfelement

19

NASA and Freemasonry

Thomas Africa reveals that Nicolaus Copernicus (1473-1543 A.D.) was not a revolutionary discoverer of a new heliocentric astronomy; he was rather a restorer of the heliocentric type of system espoused by Pythagoras of Samos (570-495 B.C.).²⁹¹ Some state that Pythagoras' system was not purely heliocentric, but that it was a system where the planets, including the sun, orbited a central, invisible fire. Nonetheless, Pythagoras' system was the first system that called for the planets to travel in a circular orbit, and so he has been recognized by the early scientists as the true founder of the heliocentric system. In fact, Johannes Kepler (1571-1630 A.D.) called Pythagoras the "grandfather of all Copernicans."²⁹² Copernicus, himself, insisted that his system was not an innovation, but was rather a revival of the lost doctrine of Pythagoras.²⁹³ Galileo Galilei (1564-1642 A.D.) viewed the papal edict of 1616 as a suppression of the "Pythagorean opinion of the mobility of the earth."²⁹⁴

Copernicus also "borrowed" from the theories of Aristarchus of Samos (310-230 B.C.) that the earth orbited the sun. Copernicus had no problem acknowledging the contributions of Pythagoras, but for some reason, he decided to conceal his knowledge of Aristarchus' writings. Thomas Africa reveals that "Copernicus knew of Aristarchus' heliocentrism but consistently

concealed this knowledge, and finally deleted his one passing reference to it, from either vanity, 'Pythagorean' scruples, or both."²⁹⁵

Pythagoras was the first person to have presented the idea of the circular orbit of spherical planets around a central fire. He is purported to have added a counter-earth to arrive at 10 orbiting planets (including the sun).²⁹⁶ Jose Wudka alleges that the added counter-earth was to explain eclipses and because the number 10 was viewed as sacred by heathen philosophers.²⁹⁷ Not coincidentally, the 10 orbiting spheres match the 10 spherical *sefirot* of the Jewish Kabbalistic god, *Ein Sof*.

Master Mason Dr. James Anderson, founder of the London Masonic Lodge, stated in his book, *Defence of Masonry*, that Freemasonry descended from Pythagoras.²⁹⁸ Master Mason William Hutchinson stated in his book, *Spirit of Masonry*, that ancient Masonic records indicate that the foundation of Freemasonry is in Pythagorean principles.²⁹⁹ Another Master Mason, William Preston, in his *Illustrations of Masonry*, states that Pythagoras was initiated into the deep mysterious Masonic principles, which he then spread to the countries in which he traveled.³⁰⁰ Albert Mackey, in the *Encyclopedia of Freemasonry* reveals the following details about Pythagoras and his Masonic connections:

In his return to Europe, he [Pythagoras] established his celebrated school at Crotona, a Dorian Colony in the south of Italy, about 529 B.C., much resembling that subsequently adopted by the Freemasons. ... Before admission to the privileges of this school, the previous life and character of the candidate were rigidly scrutinized, and in the preparatory initiation secrecy was enjoined by an oath, and he was made to submit to the severest trials of his

fortitude and self-command. ... The mode of living in the school of Crotona was like that of the modern Communists.³⁰¹

The *Jewish Encyclopedia* labels some of the Kabbalistic philosophies as Pythagorean.³⁰² Both the Pythagorean occultism and the Kabbalah flowed from Babylonian mysticism. The *Jewish Encyclopedia* asserts that Gnosticism was Jewish in character and is of “Chaldean [i.e., Babylonian] origin.”³⁰³ That indicates that the Gnosticism finds its origins from Jews in Babylon. The Kabbalah is the written memorialization of the mysticism that was adopted by the Jews during their Babylonian captivity.

The word “Pythagorean” is an adjective and seems to be used in the *Jewish Encyclopedia* to identify the kind of doctrines in the Kabbalah. They are of the same nature as Pythagorean doctrines. It certainly cannot mean that the Kabbalah flowed from Pythagoras, because the Jews were first brought into captivity in Babylon, in or about 597 B.C., which was approximately 27 years before Pythagoras was born. The Jews were released from their Babylonian captivity in or about 538 B.C.

Pythagoras was a Greek. He did not travel to Babylon until in or about 525 B.C.³⁰⁴ Pythagoras was reportedly held captive there for 5 years. Iamblichus (born in or about 250 A.D.), who was a Syrian philosopher, writes that Pythagoras “was transported by the followers of Cambyses as a prisoner of war. Whilst he was there he gladly associated with the Magoi and was instructed in their sacred rites and learnt about a very mystical worship of the gods. He also reached the acme of perfection in arithmetic and music and the other mathematical sciences taught by the Babylonians.”³⁰⁵

Pythagoras could not have been the source of any of the doctrines in the Kabbalah. Because by the time Pythagoras came on the scene, the Jews had already been held captive in Babylon,

been introduced to the Babylonian occult mysteries, and been released from their captivity. No doubt, there were many Jewish mystics still in Babylon by the time that Pythagoras arrived. It is likely that at that time Pythagoras was initiated into the mysteries of what we know today as the Kabbalah.

The *Jewish Encyclopedia*, by calling some of the Kabbalistic philosophies Pythagorean seems to be more a homage to Pythagoras that is used to describe the nature of particular doctrines found in the Kabbalah. Indeed, when called upon to identify the source of the mysticism in the Kabbalah, the *Jewish Encyclopedia* stated unequivocally that Gnosticism is of Jewish character and is of “Chaldean [i.e., Babylonian] origin.”³⁰⁶

Certainly, there could have been some synergism in the interactions between the Kabbalistic Jews and Pythagoras, but that does not erase the truth that in the end the philosophies of both the Jewish mystics and Pythagoras are rooted in occult Babylonianism. The fact that the Pythagorean theorem, for which Pythagoras is famous, was known by the Babylonians a thousand years before Pythagoras testifies to the Babylonian origins of his philosophy.³⁰⁷ S. Pancoast, who was a physician to the infamous occult theosophist H.P. Blavatsky, states that Pythagoras was a Kabbalist of the highest order.³⁰⁸ He further states that the symbols of Masonry are Kabbalistic, and were known to Pythagoras.³⁰⁹ Pancoast reveals that Pythagoras’ initiation into the secrets of the Kabbalah led Pythagoras to the heliocentric philosophy.

Pythagoras held that the Sun is the center of the solar system around which all the planets revolve; that the stars are Suns like ours, each the center of a system; that the earth revolves yearly around the Sun and daily on its axis; that the planets are inhabited, and that they and the earth are ever revolving in regular order.³¹⁰

Johannes Reuchlin (1455-1522 A.D.) was a German humanist and political counselor to the Chancellor of Germany.³¹¹ He was a classics scholar and an expert in the ancient languages and traditions (Latin, Greek, and Hebrew). Reuchlin was affiliated with the heads of the Platonic Academia (della Mirandola and others).³¹² Reuchlin confirmed that Pythagoras obtained his philosophy through the Jewish Kabbalah:

Pythagoras, who is the father of philosophy, did nevertheless not receive those teachings from the Greeks, but rather he received them from the Jews. Therefore he must be called 'a Kabbalist,' ... and he himself was the first to convert the name 'Kabbalah,' unknown to the Greeks, in the Greek name philosophy. Pythagoras' philosophy emanated from the infinite sea of the Kabbalah.³¹³

Freemasonry can be traced to Pythagoras and is a religion that is founded upon the Jewish Kabbalah. Albert Pike states in *Morals and Dogma* that "Masonry is a search for Light. That leads us directly back, as you see, to the Kabbalah."³¹⁴ Albert Mackey, in his authoritative *Encyclopedia of Freemasonry*, confirms Albert Pike's averment. Mackey states that the Kabbalah, being "[t]he mystical philosophy or theosophy of the Jews, ... is intimately connected with the symbolic science of Freemasonry."³¹⁵

Upon what authority did Albert Pike rely for writing his authoritative *Morals and Dogma of the Ancient and Accepted Scottish Rite*? Martin L. Wagner conducted an objective and thorough study of Freemasonry and wrote a book about his findings titled *Freemasonry: An Interpretation*.³¹⁶ Wagner states that "Albert Pike drew largely from the writings of Eliphaz Levi, the Abbe Constant, a great Kabbalist, and whom Buck considers as knowing more of the occult science than any one since the days of the old initiates, for illuminating and illustrating Freemasonry."³¹⁷ The Kabbalah is unadulterated witchcraft. Magic

and occult mysticism run throughout the Kabbalah. The Kabbalah contains a great deal of black magic and sorcery, and invoking the powers of devils.³¹⁹

One of the key points revealed in the Protocols of the Learned Elders of Zion is the secret use of ostensibly Gentile nations and institutions in order to further Jewish Zionist aims, while hiding the Jewish influence over those institutions. In the Protocols, the Learned Elders of Zion state that they have used Masonry as a cover to hide their involvement in the plan for a “new world order.” Paragraph two of Protocol 4 states:

Who and what is in a position to overthrow an invisible force? And this is precisely what our force is. Gentile masonry blindly serves as a screen for us and our objectives, but the plan of action of our force, even its very abiding place, remains for the whole people in unknown mystery.³²⁰

The Gentile facade of Freemasonry offers the Zionist Jews the perfect cover. We can see the same hidden control by Jews over the “Christian” Zionist movement. Freemasonry is based upon Judaism.³²¹ It is a Gentile front for Jewish mysticism, whose history, grades, and official appointments, are rooted in Jewish theosophy.³²²

The Zionists promote and control masonic lodges. They use those lodges as indispensable secret intelligence agencies and organs of influence. Paragraphs four and five of Protocol 15 states:

[W]e shall create and multiply free masonic lodges in all the countries of the world, absorb into them all who may become or who are prominent in public activity, for these lodges we shall find our principal intelligence office and

means of influence. All these lodges we shall bring under one central administration, known to us alone and to all others absolutely unknown, which will be composed of our learned elders.

* * *

It is natural that we and no other should lead masonic activities, for we know whither we are leading, we know the final goal of every form of activity whereas the goyim have knowledge of nothing.³²³

Zionist Jews use the lodges of Freemasonry as recruiting grounds for their Gentile front-men. The Gentile nature of freemasonry is only a cover; freemasonry is wholly based upon the Jewish Cabala. Using the Gentile front of freemasonry to further Zionist ends is explained in paragraphs four and seven of Protocol 11.

The goyim are a flock of sheep, and we are their wolves. And you know what happens when the wolves get hold of the flock? ... For what purpose then have we invented this whole policy and insinuated it into the minds of the goy without giving them any chance to examine its underlying meaning? For what, indeed, if not in order to obtain in a roundabout way what is for our scattered tribe unattainable by the direct road? It is this which has served as the basis for our organization of secret masonry which is not known to, and aims which are not even so much as suspected by, these "goy" cattle, attracted by us into the "show" army of masonic lodges in order to throw dust in the eyes of their fellows.³²⁴

The statements in the Protocols that Freemasonry is rooted in Judaism is confirmed by Wagner, in his study of Freemasonry. Wagner quotes Masonic authorities that reveal that “Masonry in its purity, derived as it is from the old Hebrew Kabbala as a part of the great universal wisdom religion of remotest antiquity.”³²⁵ Wagner concludes:

A candid investigation convinces us that Freemasonry is indebted in a very large measure to the Kabbalah for its philosophical ideas, its methods of interpreting the scriptures, its doctrines of emanations, its art speech, its cosmogonical views, and its veils and glyphs. In a certain sense it is a continuation of the Kabbalah under a different name and guise.³²⁶

Further confirmation of the Judaic foundations of Freemasonry comes from the authoritative Rabbi Isaac Wise. Wise confirms that the Gentile nature of Freemasonry is only a cover: “Freemasonry is a Jewish establishment, whose history, grades, official appointments, passwords, and explanations are Jewish from beginning to end.”³²⁷

The October 28, 1927 Jewish Tribune of New York stated: “Masonry is based on Judaism. Eliminate the teachings of Judaism from the Masonic Ritual and what is left?”³²⁸ Michael Hoffman concluded: “It is from these [Cabalistic and Talmudic] recondite doctrines of Judaism that the Freemasons and other occult workers of iniquity derive their beliefs.”³²⁹ Henry Makow describes Freemasonry as “Judaism for Gentiles.”³³⁰ Makow states that it is “a way for the Cabalistic Jewish elite to enlist Gentiles in their conspiracy.”³³¹

What are the religious doctrines flowing from the Kabbalah that form the foundation of Freemasonry? It is the worship of Lucifer. Albert Pike, the theological pontiff of

Freemasonry, explains:

That which we must say to a crowd is—We worship a God, but it is the God that one adores without superstition. To you, Sovereign Grand Inspectors General, we say this, that you may repeat it to the Brethren of the 32nd, 31st, and 30th degrees—The Masonic Religion should be, by all of us initiates of the high degrees, maintained in the purity of the Luciferian Doctrine. If Lucifer were not God, would Adonay whose deeds prove his cruelty, perfidy and hatred of man, barbarism and repulsion for science, would Adonay and his priests, calumniate him? Yes, Lucifer is God, and unfortunately Adonay is also God. For the eternal law is that there is no light without shade, no beauty without ugliness, no white without black, for the absolute can only exist as two gods: darkness being necessary to the statue, and the brake to the locomotive. Thus, the doctrine of Satanism is a heresy; and the true and pure philosophical religion is the belief in Lucifer, the equal of Adonay; but Lucifer, God of Light and God of Good, is struggling for humanity against Adonay, the God of Darkness and Evil.³³²

Adonay is the Hebrew word used in the Old Testament that is the name for God and is translated into English in the bible as “Lord.” Pike blasphemously calls God “the God of Darkness and Evil.” Pike calls Lucifer, the “God of Good.” Pike admits that Lucifer is the Masonic god of light. “And no marvel; for Satan himself is transformed into an angel of light.” (2 Corinthians 11:14) In his authoritative treatise, that is to this day the doctrinal bible of Masonry, *Morals and Dogma*, Pike pays homage to the god of Freemasonry: “Lucifer, the Light-Bearer! Strange and

mysterious name to give to the Spirit of Darkness. Lucifer, the Son of the Morning! Is it he who bears the light, and with its splendors intolerable blinds feeble, sensual or selfish Souls? Doubt it not!”³³³ Lucifer’s name in fact means “light bearer.” The Masonic initiation ceremonies finds the candidate repeatedly seeking more light. If the candidate reaches the highest degree of Freemasonry, he will be informed that the light he seeks is found in the light bearer, Lucifer, who is the god of Freemasonry.

Manly P. Hall, 33° Freemason and highly respected Masonic authority, explains that “[w]hen the Mason learns that the key to the warrior on the block is the proper application of the dynamo of living power, he has learned the mystery of his Craft. The seething energies of Lucifer are in his hands and before he may step onward and upward, he must prove his ability to properly apply energy.”³³⁴

Heliocentrism is a fundamental tenet of the Kabbalah. Consequently, heliocentrism is central to Freemasonry. Many Masonic lodges throughout the world are named in honor of Copernicus.³³⁵ The following praise of Copernicus is from the 1843 Freemasons’ Quarterly Review.

Copernicus, and his successors in the study of the starry firmament, have supplanted the art of astrology by proving that all the movements of the heavenly bodies tend to promote the honour and glory of the Great Architect of the Universe.³³⁶

The link between heliocentrism and Freemasonry explains the close affiliation between Freemasonry and NASA. For example, James Edwin Webb, who was the NASA administrator from 1961-68, was a Freemason. In the November 1969 edition of the Masonic Magazine, *The New Age*, there appeared an article written by 33° Freemason Kenneth S. Kleinknecht, who was the

Manager of the Apollo Program Command and Service Modules, the Deputy Manager of the Gemini Program; and the Manager of Project Mercury. Kenneth S. Kleinknecht, by the way, is the brother of C. Fred Kleinknecht, 33°, Sovereign Grand Commander, The Supreme Council (Mother Council of the World), Southern Jurisdiction, USA, Washington. In *The New Age* article, Kenneth Kleinknecht stated:

Note how many of the astronauts themselves are Brother Masons: Edwin E. Aldrin, Jr.; L. Gordon Cooper, Jr.; Donn F. Eisele; Walter M. Schirra; Thomas P. Stafford; Edgar D. Mitchell, and Paul J. Weitz. Before his tragic death in a flash fire at Cape Kennedy on January 27, 1967, Virgil I. "Gus" Grissom was a Mason, too. Astronaut Gordon Cooper, during his epochal Gemini V spaceflight in August of 1965, carried with him an official Thirty-third Degree Jewel and a Scottish Rite flag. Via the lunar plaque, the Masonic ensignia and flag, and the Masonic astronauts themselves – Masonry already is in the space age. Can we doubt Freemasonry and its spiritual relevance to the modern era when even its material representatives have today made historic inroads into the infinite expanses of outer space?³³⁷

The Grand Lodge of Texas, A.F. & A.M., has posted the following explanation on the internet, regarding its chartering of a Masonic Lodge on the moon, which is titled Tranquility Lodge No. 2000.

On July 20, 1969, two American Astronauts landed on the moon of the planet Earth, in an area known as Mare Tranquilitatis, or "Sea of Tranquility". One of those brave men was

Brother Edwin Eugene (Buzz) Aldrin, Sr., a member of Clear Lake Lodge No. 1417, AF&AM, Seabrook, Texas. Brother Aldrin carried with him SPECIAL DEPUTATION of then Grand Master J. Guy Smith, constituting and appointing Brother Aldrin as Special Deputy of the Grand Master, granting unto him full power in the premises to represent the Grand Master as such and authorize him to claim Masonic Territorial Jurisdiction for The Most Worshipful Grand Lodge of Texas, Ancient Free and Accepted Masons, on The Moon, and directed that he make due return of his acts. Brother Aldrin certified that the SPECIAL DEPUTATION was carried by him to the Moon on July 20, 1969.³³⁸ (emphasis in original)

 pdfelement



Figure 113: Freemason Buzz Aldrin (right) with Luther A. Smith, the Masonic Sovereign Grand Commander, holding the Masonic flag Aldrin took with him when he allegedly landed on the moon.

Buzz Aldrin was interviewed by Alex Jones in 2009. During the interview, there was the following exchange between Alex Jones and Buzz Aldrin:

Alex Jones: “Mr. Aldrin I always wanted to ask you this. We saw the photos of the little Masonic flag to the moon and some of the names of the missions and the numerology, is there anything to that? Or what is the Masonic influence? We know there’s Masonic influence in the founding of the country; what is the Masonic influence on NASA?”

Aldrin: “As far as I can tell, zero. There were

some Masonic brothers of mine in Texas that wanted me to take some kind of a Masonic emblem to the moon, in some gesture of – I don't know what it would be a gesture of – but I told them that it was not within my authority to do such a thing.”³³⁹

Aldrin is on record with a September 19, 1969, letter he sent three days after meeting with the heads of the Scottish Rite of Freemasonry in the House of the Temple in Washington D.C., acknowledging that he presented the very flag he denied carrying to the moon during the 2009 Alex Jones interview.

 pdfelement

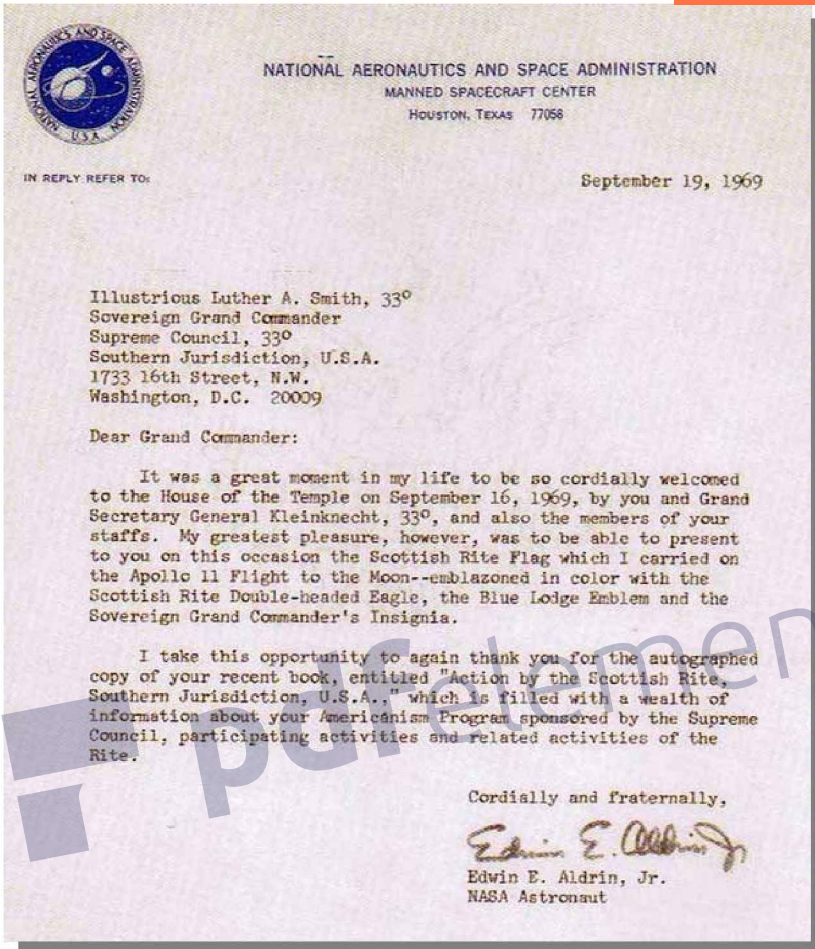

Furthermore, there was an article in the December 1969 issue of the Masonic magazine, *New Age* (the official organ of the Scottish Rite Southern Jurisdiction), which included a picture of Aldrin presenting to the Scottish Rite headquarters in Washington, the "Masonic emblem" which he allegedly carried with him to the moon and back.

Why would Aldrin lie about the Masonic connection to NASA? Because, it would reveal the real power and influence

behind NASA. Pulling on that thread would expose the hidden agenda. Didn't Aldrin know that he was on record as claiming that he carried a Masonic flag to the moon in the September 19, 1969, letter sent to the heads of the Scottish Rite of Freemasonry? He certainly knew of the letter and that the Masonic brotherhood knew of his claimed possession of a Masonic flag on the moon. So many communications, however, within Masonry are secret and sealed by blood oaths that he probably was confused as to which of the many communications he has had within Masonry were public. His life is so compartmentalized between his public facade, which is mostly based upon deception, and his private Masonic communications, which are for the most part secret, that he simply could not keep the secret Masonic communications from the few public Masonic communications straight in his mind. Without much time to reflect on his answer to the unexpected question from Alex Jones, Aldrin simply resorted to his standard operating procedure; he lied.

There has been (and probably continues to be) a controlling faction making up a statistically unlikely plurality of Masonic astronauts and administrators at NASA.³⁴⁰ In fact, Kleinknecht's list of Masonic astronauts in his *New Age* article is by no means complete. For example John Glenn Jr. (Mercury 6), James Irwin (Apollo 15), and Fred Haise (Apollo 13), all of whom were Freemasons, are missing from Keinknecht's honor roll of astronaut Freemasons.

Freemasons are very proud of their NASA connection. Aldrin's denial of any Masonic connection to NASA suggests that knowledge of the connection is to be kept within the Masonic brotherhood. Below is a Masonic medallion struck in commemoration of the 10th anniversary of the Apollo 11 alleged moon landings.



The following description of the medallion appears on the Phoenix Freemason Museum website:

This 1979 medallion was struck to commemorate the 10th Anniversary of our flags on the moon. Many people were never aware that Astronaut and Brother Neil Armstrong carried aboard on his Apollo flight to the moon 2 (two) flags. One was the American flag, the other was a flag designed by the Southern Jurisdiction of the Scottish Rite depicting the double-headed eagle emblem. This flag now resides in the museum collection of the Scottish Rite Museum at the House of the Temple. It is a spectacular three-dimensional medallion and measures 1 3/4 inches in diameter. It was made by the Medallic Art Co. of Dansbury, CT.³⁴¹

Richard Hoagland, who was a former Science Advisor to CBS News during the Apollo program, from 1968–1971, alleges in his book, *Dark Mission: The Secret History of NASA*, that NASA is controlled by Freemasons, and from NASA's beginnings, it has had an occult underside that has been carefully

concealed from the public.³⁴² While Hoagland's statement is true, Bill Kaysing has good reason to believe that Hoagland is a shill, working for NASA, who is trying to divert attention away from the fact that NASA never went to the moon.³⁴³ From 1956 to 1963, Kaysing was the head of technical publications for the entire propulsion laboratory at Rocketdyne, which was a research facility for the development of large liquid propellant rocket engines. Rocketdyne was a division of North American Aviation and later of Rockwell International, which built the Saturn V rockets used in the NASA Apollo Missions. While at Rocketdyne, Kaysing had top secret clearance, which gave him access to documents pertaining to the Mercury, Gemini, and Apollo programs. Kaysing became convinced by what he saw at Rocketdyne and subsequent research that the Apollo moon landings were a complete hoax. He set forth his evidence in a book, first published in 1976, titled: *We Never Went to the Moon: America's Thirty Billion Dollar Swindle*.

There seems to be merit to Kaysing's allegation about Hoagland. Hoagland has made an effort to spin the evidence of the clearly faked NASA photos and videos, not as proof that the moon landings never took place, but rather as proof that NASA is concealing the existence of space aliens. In the intelligence community, that is called a limited hangout, where a part of a conspiracy is seemingly exposed by a shill, in order to spin the people in a direction away from the truth and provide some plausible, but less nefarious, explanation for the government deception.

Hoagland avers that only some of the moon photos and videos are faked. He advocates a position that NASA went to the moon, and NASA doctored only some of the photographs to hide evidence of intelligent life. In a radio interview, Hoagland stated:

I'll give you my bottom line. I think that there is an enormous Apollo conspiracy, but I think we've been sold the wrong conspiracy, to keep

people like you, bright guys who are asking good questions, looking in the wrong direction, which these people are task masters at doing. The real conspiracy is not did we go to the moon, but what did we find on the moon that they don't want you to know. I have found areas where NASA faked the imagery, I believe to hide really cool stuff.”³⁴⁴

Hoagland uses hyperbole and inaccurate information. One way the intelligence community discredits opposition to its programs is to expose inaccuracies that have been sown by its own shells. Care should be taken to verify the facts. That is why this author has provided endnotes establishing the authority for virtually every fact in this book.

Hoagland presents some evidence that is true (the occult Masonic influence in NASA and the fake photos and videos) but then spins their significance away from hoaxed moon landings and toward space aliens. That serves to discredit the information about the occult practices and the fake photos and thus causes many people to dismiss any thought that the moon landings were fake. For other people, Hoagland's theory of NASA fabricating videos and photos in order to conceal life on other planets gives some plausible, less nefarious, explanation for the NASA deception and serves to steer those people away from the fact that NASA did not go to the moon. The purpose for NASA's existence is to conceal the flat earth in order to condition people to believe the Satanic lie of a spinning orbiting earth where man is an insignificant part of an infinite, godless universe. Hoagland furthers that end.

Most who have exposed the fraud of NASA seem to give little thought to motive behind faking the moon landings. Some ascribe the motive to distraction from the Vietnam War, others to cold war prestige, but the motive most often ascribed to NASA is money. Certainly, NASA swindled multi-billions of dollars from

the U.S. taxpayer. The money swindled was certainly profitable for those behind the moon landing hoax conspiracy. The real objective was not to gain a short term profit, but to grow the love of money in the hearts of men as a way to control and enslave the world. "The love of money is the root of all evil." 1 Timothy 6:10 The love for money must be made to grow, and that is the motive behind the moon landing hoax. In order for the root of evil to grow deep into the soil, that soil must be tilled by the lie that there is no God. In order to grow the love for money in men's hearts, men must be convinced that there are no eternal consequences for lying, cheating, and stealing to get money. That requires that men believe that there is no God who can mete out any punishment for sin. That in turn necessitates that man be kept ignorant that he is made by God, in God's image, on the flat earth, which is at the center of his creation. The moon mission serves to beguile men into believing in a godless, endless universe, where man is on an insignificant spherical planet careening through space.

The key to understanding the moon landing hoax is to realize that it is not scientific deception, it is spiritual deception. Symbolism is important in witchcraft. The NASA logo includes the forked tongue of a serpent to symbolize that it is under the control of the great serpent, Satan. "And the great dragon was cast out, that old serpent, called the Devil, and Satan, which deceiveth the whole world: he was cast out into the earth, and his angels were cast out with him." Revelation 12:9.

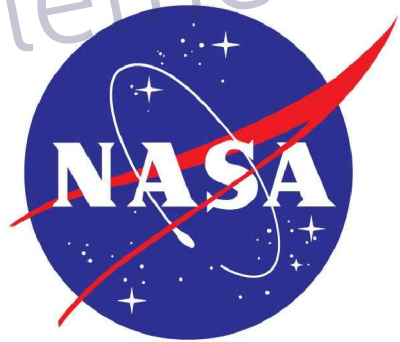

It is significant that the NASA moon missions were named Apollo. Apollo is the Greek sun god. Apollo is often depicted riding a horse drawn chariot with the sun shining behind him. Notice in the Apollo XIII emblem, Apollo himself is not seen. The depiction seems to be of the horses coming from earth; however, there is no chariot. In view of the missing chariot, the horses could be interpreted as drawing the earth behind it, which suggests that the earth itself is the chariot of Apollo. Satan is described in the bible as “the god of this world” (2 Corinthians 4:3-4), who blinds the minds of the lost to the light of the gospel of Jesus Christ.

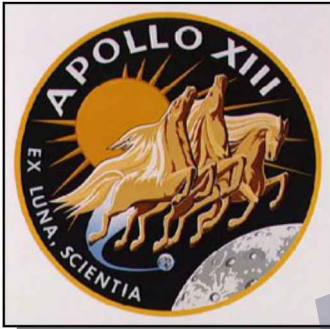

Figure 117: Official NASA Emblem for the Apollo XIII Mission

Apollo is the same Apollyon referenced in Revelations as the angel of the bottomless pit. “And they had a king over them, which is the angel of the bottomless pit, whose name in the Hebrew tongue is Abaddon, but in the Greek tongue hath his name Apollyon.” (Revelation 9:11) The Edinburgh Encyclopedia states:

On this passage, Hensius makes the following observation: There can be no doubt that the Pythian Apollo is the same as the Ob and Abaddon of the Hebrews which the Greeks translated literally as Apollyon.³⁴⁵

In Wakeman Ryno's *Amen: The God of the Amonians Or a Key to the Mansions in Heaven*, he states that the reference to Apollyon in Revelation 9:11 is a reference to Apollo, who is Satan. “Satan, Belial, Lucifer, Abaddon, and Apollyon are all one and the same — the Sun (Apollo) in the Sign of the Scorpion, the king of the bottomless pit.”³⁴⁶ (parenthetical in original). The god

of Freemasonry is Lucifer, so it is not surprising that Masonic influenced NASA would name its moon missions after the Masonic god, Apollo (Lucifer). The NASA Apollo missions were central to conditioning the world into believing the lie of a spinning spherical Earth, orbiting the sun.

Texe Marrs summarizes the Masonic beginnings and the Satanic aims of NASA:

NASA's space program has from the start been founded on the principles of Masonic alchemy and the magic of the mystery religions of the ancients. The prophet Daniel told us that the last day's world ruler, the antichrist king, would be mighty, "And through his policy also he shall cause craft to prosper..." Craft, as in witchcraft! ... The earliest beginnings of the U.S. space program involved the secretive OSS/CIA project, Operation Paperclip, in which Nazi rocket scientists like Werner Von Braun were brought from war-torn Germany to America and given responsibility for development of space vehicles. The Freemasons were then put in charge of the newly created space agency, and magic and witchcraft were integrated and wedded with the newest advances in technology. ... Virtually everything that NASA does is permeated with magic and alchemy. Moreover, the real purpose of NASA is contained in another matrix, hidden from the public at large. This process involves the creation of Satanic ritual magic enabling the Illuminati elite to acquire and accumulate power even as the mind-controlled and manipulated masses are pushed into ever increasing states of altered consciousness.³⁴⁷

Freemasonry is the child of the Jewish ~~Rabbinical~~. Freemasonry, at the highest levels, is under Zionist control, which means that NASA is ultimately under Zionist control. In witchcraft there are double meanings to acronyms and words. NASA is of course an acronym for the National Aeronautics and Space Administration. *Nasa* is also a Hebrew word that means to lift up, to carry off, or to exalt oneself.³⁴⁸ The Hebrew word *Nasa* additionally means to cause to bear iniquity.³⁴⁹

The Zionist influence within NASA is well hidden. There are, however, indications of Zionist influence within NASA. One example is the Columbia Shuttle Mission STS-107 emblem. The Space Shuttle Mission STS-107 was a disastrous mission, during which the Columbia Shuttle was destroyed when it allegedly reentered the atmosphere on February 1, 2003. It is the proper protocol for a commemorative emblem to display the flag of the host country along with the flag of a guest astronaut's country. The Columbia Shuttle Mission STS-107 emblem was notable for its glaring breach of proper protocol, in that it displayed only the flag of the guest astronaut's country, without displaying the flag of the host country, which was the United States. What country was the guest astronaut from? He was from Israel. The presence of the flag of Israel on the Columbia Shuttle Mission STS-107 emblem, without also including the flag of the United States, was intended as a not-so-subtle symbol of Israeli hegemony over NASA and the United States Government.

The inclusion of the flag of Israel, and the exclusion of the U.S. flag, is a portent of things to come. Israel will ultimately stab the U.S. in the back. Before Israel does that, it will milk the U.S. for all it can. Indeed, Israeli Prime Minister Benjamin Netanyahu was overheard by a CIA agent saying to his supporters after visiting Jonathan Pollard's jail cell, that "[o]nce we squeeze all we can out of the United States, it can dry up and blow away." Pollard is a Jewish spy who was caught spying on the U.S. for Israel. Rafi Eitan, who is a Mossad spymaster, an advisor to Fidel

Castro, and an Israeli cabinet minister, told one of Israel's largest daily newspapers, *Yediot Aharonot*, in June 1997: "I failed in the Pollard affair, just as I failed in other intelligence operations beyond enemy lines." Eitan's statement indicates that Israel considers the United States an enemy. For more information on the duplicity of Israel, read this author's book, *9/11-Enemies Foreign and Domestic*.

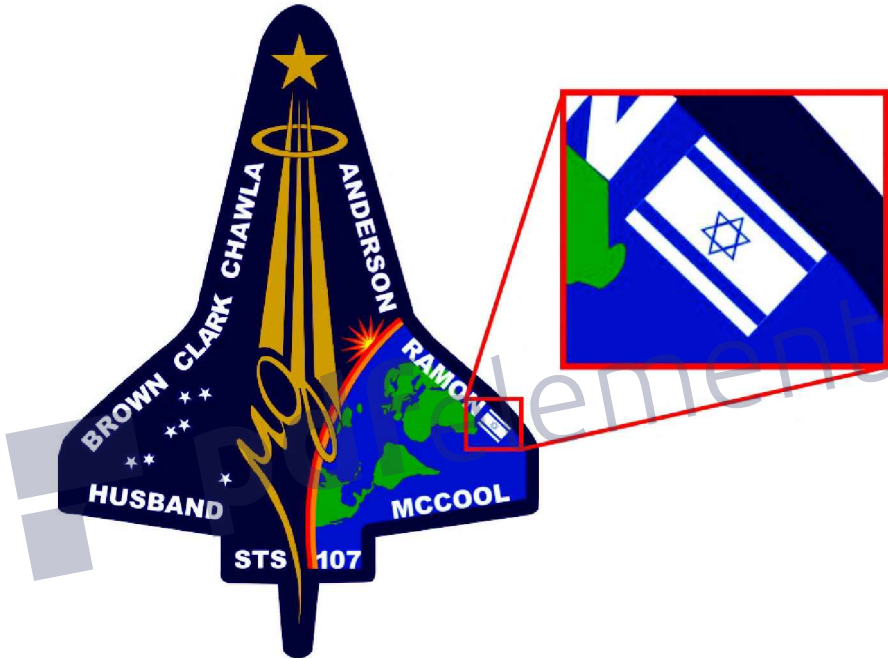

NASA and the Israel Space Agency (ISA), for a long time, have had a very close working relationship. For example, in 1986, NASA and ISA entered into a formal agreement to share technology.³⁵⁰ That agreement is the means by which massive amounts of highly sensitive technology, developed by NASA at taxpayer expense, is handed over to Israel.

Interestingly, the American-Israeli Cooperative Enterprise revealed that in "October 1999, Ben-Gurion University researchers joined an international project to map the earth sponsored by

NASA, the German space agency DARA and the Italian Space Agency ASI.”³⁵¹ Certainly, that earth mapping project is all part of the international effort to conceal the flat earth. The alleged NASA Curiosity Rover mission to Mars in November 2011, is claimed by Israel to have included an Israeli-manufactured refrigerator.³⁵²

Israel is interested in obtaining technology from NASA, and NASA is all too obliging. That explains, for example, Israel’s hosting of the 2015 International Astronautical Conference (IAC), which was held in Jerusalem. At that conference, Israel announced yet another partnership between the Israel Space Agency (ISA) and NASA, which involves “joint missions, personnel and scientific data exchanges, ground-based research facilities.”³⁵³

The technology sharing agreements with the U.S. are on their face bilateral, but in fact are one-sided. Make no mistake about it, Israel has advanced technology, but it has very little to share with the U.S. Virtually all of Israel’s technology has been given to it by or stolen from another country, usually the U.S. Israel, however, does share technology obtained from the U.S. with other like minded countries. There has been a long, albeit secret, history of mutual cooperation between communist China and Israel in the development of nuclear and other military weapons. In fact, Israel has been cited as one of the primary conduits for the flow of U.S. and other western technologies to communist China. No one who is a patriotic American would ever enter into the one-sided technology sharing agreements with Israel. The one-sided agreements were ratified by NASA officials, because Israel controls NASA. Masonic officials at NASA simply go along with whatever Israel wants.

ISA is not truly a space agency; it is an intelligence agency, whose purpose is to obtain as much U.S. technology as it can get. The technology sharing agreements between the NASA and ISA are in reality technology hand-over agreements, where U.S. advanced technology is delivered to Israel. For a more

complete explanation of Israel's hegemony over the U.S. Government, read this author's book, *Bloody Zion*.

 pdfelement

20

Media Gatekeepers

Those behind the NASA deception will do anything to keep a lid on the moon landing hoax. For example, the first edition of *We Never Went to the Moon* came out in the Spring of 1975. That year, the author, Bill Kaysing, did a number of radio interviews. On December 7, 1975, Kaysing was being interviewed by Victor Boc on radio station KOME in San Jose, California. In the middle of the radio show, an engineer came in and announced that they were off the air.³⁵⁴ It turned out that someone had dropped a napalm bomb from a helicopter on the KOME transmission towers in the Gilroy Hills, causing \$250,000 in damage and putting the radio station off the air for three days.³⁵⁵ It was clear to law enforcement that the reason for the bombing was to stop the interview of Kaysing about the moon landing hoax from being broadcast. They feared that Kaysing, himself, might be in danger; he was therefore offered police protection.³⁵⁶

The media gatekeepers are typically more sophisticated than using bombs. They have much more subtle ways of hindering mass awareness of the NASA moon landing hoax. The bombing, however, illustrates their resolve (or more aptly their desperation) in suppressing knowledge of the hoax. The reason that there is such an impetus to keep a lid on the Apollo moon hoax is that

exposure of it will lead to the question of why the U.S. would take a moon landing. Many people would then discover that the moon landings were hoaxed for the purpose of concealing the firmament and the flat earth. Satan and his minions cannot allow that to happen.

An example of the efforts to keep the masses ignorant of the flat earth is the recent shut down of the International Flat Earth Research Society (IFERS) forum. That forum, formerly found at <http://ifers.boards.net/>, was shut down on December 31, 2015. The message that appears across the screen when accessing the above URL is: “In accordance with Section 25(a) of the ProBoards Terms of Service, this forum has been taken offline.” Section 25(a), in pertinent part, states:

PROBOARDS RESERVES THE RIGHT TO, IN PROBOARDS’ SOLE DISCRETION AND WITHOUT NOTICE OR LIABILITY, DENY USE OF THE WEBSITE AND/OR SERVICES TO ANY PERSON FOR ANY REASON OR FOR NO REASON AT ALL.³⁵⁷ (emphasis with all caps in original)

Basically, ProBoards decided to shut down the IFERS forum, because their terms of service allows them to do so “for any reason or for no reason at all.” ProBoards is one of the largest forum hosting sites in the world. It hosts over 3,000,000 internet forums, with a combined 22,800,000 users worldwide and a total of over 600 million page views per month.

The administrator of the IFERS, Eric Dubay, revealed that ProBoards shut down the IFERS forum without any notice to Dubay or any of the IFERS administrators. The IFERS forum was becoming quite popular and an important source of information about the flat earth. At the time of its shutdown, IFERS had more than 3,000 members and more than 50,000 visitors each month.³⁵⁸

Dubay addressed the continuous effort of ProBoards to censor him and IFERS, before finally shutting IFERS down:

This was not the first act of censorship by Proboards as well. A few months ago they also threatened to delete our entire forum if we didn't remove within 48 hours the thread for my documentary Adolf Hitler vs. The Jew World Order claiming "racism and hate speech." We begrudgingly complied but all sent very polite and in-depth messages to Proboards explaining how nothing in the documentary was "hateful or racist," and were received with similar silence.³⁵⁹

Dubay further explained how Facebook also deleted his account three times. He is now on his fourth Facebook account.³⁶⁰ This author had visited the IFERS forum before its shutdown. The forum had many good resources. This author disagrees with some of the posts, particularly Dubai's attacks on Christianity. This author has, nonetheless, cited to Dubai's flat earth writings on several occasions in this book, which, of course, should not be interpreted to mean that I agree with Dubai's other political or religious beliefs, which he has every right to express. It is notable that ProBoards never threatened to shut down Dubai's forum because of his attacks on Christianity. It was only after he posted a video that exposed the Jewish elite's plans for world domination that he was threatened with a shutdown.



Dubay's undoing was his connection of heliocentrism and the flat earth coverup to the elite Jews. It is not surprising that he

came to that conclusion, as that is where any diligent study of the flat earth and the origins of heliocentrism leads. That was a bridge too far, however, for the Zionist elite to allow. They simply could not permit the Jewish connection to be revealed on a public forum. Consequently, the IFERS forum was shut down.

The Jewish elite are starting to flex their financial and political muscles. They are slowly beginning to undermine the freedom of internet media outlets. They have long ago strangled any free access to the major media outlets. Other than to ridicule, discussion of the Apollo moon hoax or a belief in a flat earth is simply not allowed in the major media. The major media outlets are under Jewish control. John Whitley reported in 2003 that “seven Jewish Americans run the vast majority of US television networks, the printed press, the Hollywood movie industry, the book publishing industry, and the recording industry.”³⁶¹ He explained that “[m]ost of these industries are bundled into huge media conglomerates.” He listed the Jewish men and stated that “[t]hose seven Jewish men collectively control ABC, NBC, CBS, the Turner Broadcasting System, CNN, MTV, Universal Studios, MCA Records, Geffen Records, DGC Records, GRP Records, Rising Tide Records, Curb/Universal Records, and Interscope Records.”³⁶² Whitley’s research revealed:

Most of the larger independent newspapers are owned by Jewish interests as well. An example is media mogul Samuel I. ‘Si’ Newhouse, who owns two dozen daily newspapers from Staten Island to Oregon, plus the Sunday supplement Parade; the Conde Nast collection of magazines, including Vogue, The New Yorker, Vanity Fair, Allure, GQ, and Self; the publishing firms of Random House, Knopf, Crown, and Ballantine, among other imprints; and cable franchises with over one million subscribers.³⁶³

Whitley's conclusions are as valid today as they were in 2003. Whitley explains why: "I could add that Michael Eisner could depart Disney tomorrow but the company will remain in the hands of Shamrock Holdings, whose principal office is now located in Israel."³⁶⁴ For a more complete discussion of this issue, read this author's book, *Bloody Zion*.

The major choke points for information on the internet are owned by Jews, including, but not limited to, Google, YouTube (a division of Google), Yahoo, Facebook, and Wikipedia. The Zionist influence over those companies is palpable. For example, Google's Sergey Brin, Facebook's Mark Zuckerberg and Yahoo's President Susan Decker attended a presidential panel on technology, presided over by Israel's President Shimon Peres, during Israel's 60th anniversary celebrations, May 13-15, 2008.³⁶⁵ Google has established a research and development center in Israel.³⁶⁶ Google actively censors articles and whole websites that are critical of Israel or reveal the criminal machinations of the Jews.³⁶⁷ Google follows dictates from ADL and other Zionist organizations to adjust its search robots to censor websites that are viewed as critical of Jews or Zionism.³⁶⁸

Another flat earth forum was quickly set up by a rival of Eric Dubay on ProBoards, after the demise of IFERS.³⁶⁹ The new forum is called The Flat Earth Skeptic's Society (FESS). The interesting thing about that forum is that they created a forum board topic category titled, "Jesuits, Not Jews, Rulers of All Evil."³⁷⁰ That is a first for any forum: set up a topic, which by its terms, prohibits discussion of a topic. As Queen Gertrude said in Hamlet: he "doth protest too much, methinks." It seems that the new forum is going to gate keep the site to steer clear of anyone connecting heliocentrism to the Jews. As of this writing there have been no posts to that topic.

Dubay is not the only one who has suffered from censorship on the flat earth issue. Sometimes the gatekeepers use

their power and influence to put pressure directly on the flat earth advocates themselves to shut down discussion of flat earth. For example, popular Christian radio host Rob Skiba, under pressure, shut down his website on August 16, 2015. His website addressed the issue of the flat earth.³⁷¹ Skiba later repented of his action in shutting down the website and put the website back online.³⁷² Skiba explained his actions:

[A]lmost since day one, this "quest for truth" has brought us nothing but pain and significant damage - emotionally, spiritually and especially financially. The attacks have been relentless. This tells me that there must be something to it, for the enemy to respond that way. I've covered many controversial subjects in my life, but none have even come close to bringing the kind of resistance as this one. So, the day I shut this site down, I was really feeling like I never should have even gone down this "rabbit trail" in the first place and I had truly had enough of it all. But I now realize that was selfish of me. I know many people have come to rely on this site for their own quest for truth, so I am sorry. My "haters" have been so vocal that I ended up forgetting how many supporters we have too.³⁷³

The pressure applied to Skiba gives you some idea of the behind-the-scenes pressure that may have been applied to the owners of ProBoards to shut down the IFERS forum. Skiba did not go into specifics, but suffice it to say that the flat earth controversy brings with it attacks from all sides by Satan and his minions. While Skiba has many videos and other information on his website proving that the earth is flat, he has also posted on his website a statement averring that he considers those alleging that he believes that the earth is flat are “exceptionally ignorant, slanderous, backstabbing posers and lovers of gossip.”³⁷⁴ Apparently Skiba

thinks it is slanderous backstabbing to be spoken of as believing that the earth is flat. That should give you some idea of how effective Satan has been in creating a spherical earth hive mentality. Anyone found in the hive who does not accept the orthodox view that the earth is a globe is attacked. Skiba has been cowed and fears being attacked by the hive. He stated on his website: “What if I am wrong about the globe view? Am I prepared to deal with the resulting aftermath of scorn and ridicule that is sure to follow?”³⁷⁵ Skiba’s official stated position as of this writing is that he still believes that the earth is a globe, and he is simply weighing the merits of both sides of the debate. We must take to heart the admonition from God:

Put on the whole armour of God, that ye may be able to stand against the wiles of the devil. For we wrestle not against flesh and blood, but against principalities, against powers, against the rulers of the darkness of this world, against spiritual wickedness in high places. Wherefore take unto you the whole armour of God, that ye may be able to withstand in the evil day, and having done all, to stand. Stand therefore, having your loins girt about with truth, and having on the breastplate of righteousness; And your feet shod with the preparation of the gospel of peace; Above all, taking the shield of faith, wherewith ye shall be able to quench all the fiery darts of the wicked. And take the helmet of salvation, and the sword of the Spirit, which is the word of God: Praying always with all prayer and supplication in the Spirit, and watching thereunto with all perseverance and supplication for all saints;” (Ephesians 6:11-18)

21

Map of the Flat Earth

Most have a difficult time understanding the flat earth, because since childhood, they have been conditioned by the ubiquitous depiction of the earth as a globe. The first scientific object displayed to them in the classroom was typically a globe of the earth. They have been instructed in their early lessons of world history about how Magellan circumnavigated the globe.

Once one sees just how the flat earth truly exists, it will be easy to understand how Magellan could be believed to have circumnavigated the globe, when in fact he simply circumnavigated a plane.

In the depiction below we see that the earth is flat with the north pole in the center of a circular plane. The south is at all points at the perimeter of the plane. Antarctica actually covers the entire circumference of the earth plane.

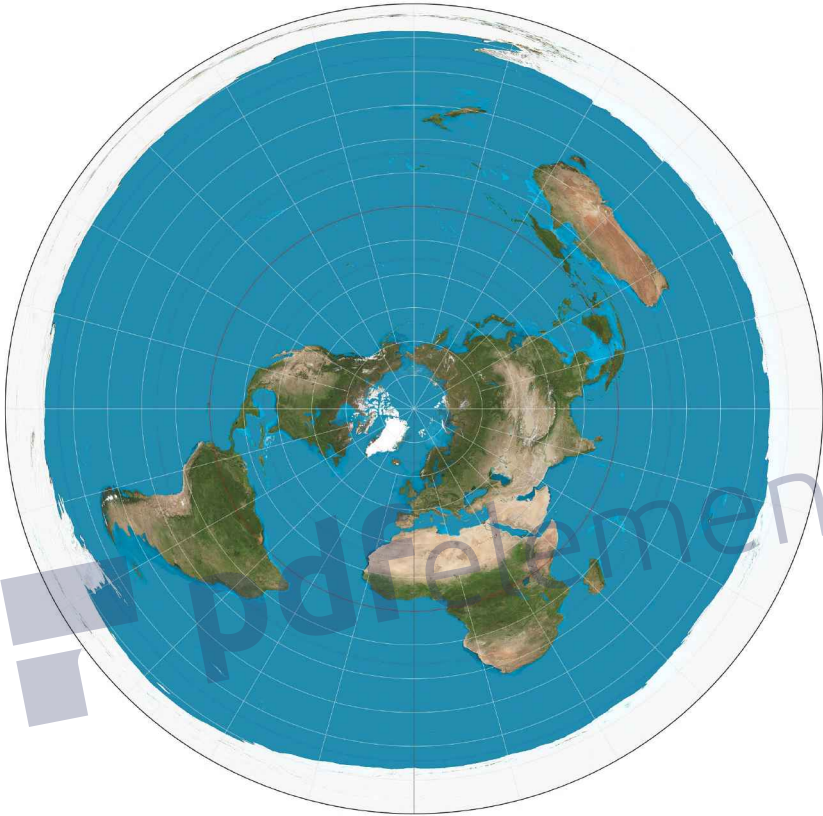

The above map is in fact called a polar azimuthal equidistant map. According to the United States Geological Survey (USGS), azimuthal maps are considered to be accurate in displaying continents and oceans.³⁷⁶ Because of their accuracy they are used for air and sea navigation. Indeed the USGS states that the azimuthal equidistant maps are “used by USGS in the National Atlas of the United States of America™ and for large-scale mapping of Micronesia. Useful for showing airline distances from center point of projection.”³⁷⁷

North is the center of the flat earth, and south is a direction emanating out from the North Pole to the outer rim of Antarctica. Thus, longitude lines are north/south lines that splay out from the North Pole to the outer rime of Antarctica, much like the spokes on a wheel, with the North Pole being the hub and Antarctica being the rim. East and west are directions circling the North Pole between equidistant points from the North Pole anywhere on the globe. Thus, latitude lines are east/west circles with points equidistant from the North Pole. If you travel east or west at the same latitude you will eventually circumnavigate the earth and wind up at your starting point. Circumnavigation does not necessitate that the earth be a globe. Magellan circumnavigated the flat earth.

Antarctica is the rim of the flat earth. Upon reaching Antarctica, explorers are first met with a massive ice wall that is between 1,000 and 2,000 feet thick, with 100 to 200 feet of that thickness rising above the water.³⁷⁸ One of the first explorers to see the Antarctic ice wall was Sir James Clark Ross, a British Naval Officer and polar explorer. Ross was confronted with a shear cliff of ice perfectly level on top that he estimated to be between 150 and 200 feet high extending east and west as far as the eye could see. Ross famously described the Antarctic ice wall:

It was an obstruction of such character as to leave no doubt in my mind as to our future proceedings, for we might as well sail through the cliffs of Dover as to penetrate such a mass.

It would be impossible to conceive a more solid-looking mass of ice; not the smallest appearance of any rent or fissure could we discover throughout its whole extent, and the intensely bright sky beyond it but too plainly indicated the great distance to which it reached southward.³⁷⁹



Figure 121: Antarctic Ice Wall

The USGS admits that the azimuthal equidistant map is accurate for all distances and directions from the center point on the map. The USGS, however, claims that the map is only accurate when the starting point is from the center of the map. In the above map of the flat earth, therefore, the USGS admits that all distances and directions from the North Pole to anywhere on the map traveling south are accurate, but claims it is not necessarily accurate when starting from any other point on the map other than the North Pole.

Notice the similarity between the UN flag logo below and the flat earth map. The only thing that the UN left off the flag is Antarctica. The skeletal world government set up to enslave the world knows that the earth is flat and they have hidden their flat earth secret in plain view.



Notice also the number of sections in the UN Flag logo. There are exactly 33 sections, which correlates nicely with the 33 degrees of the Scottish Rite of Freemasonry.

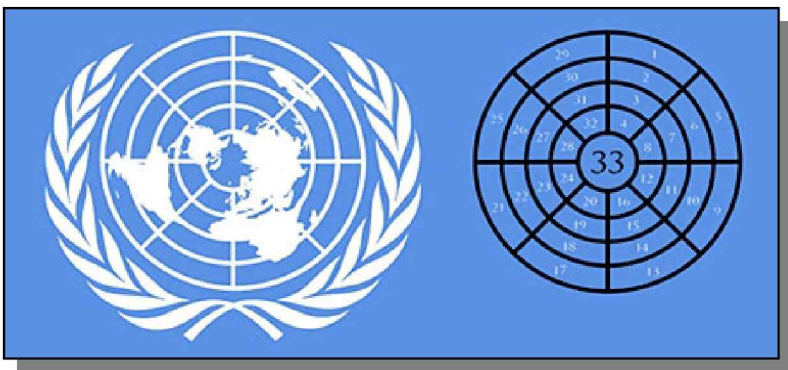

One might wonder, where is the equator? In the Polar azimuthal equidistant map below, the Equator, Tropic of Cancer, and Tropic of Capricorn are all clearly labeled.

World North Pole Azimuthal Equidistant Projection Map

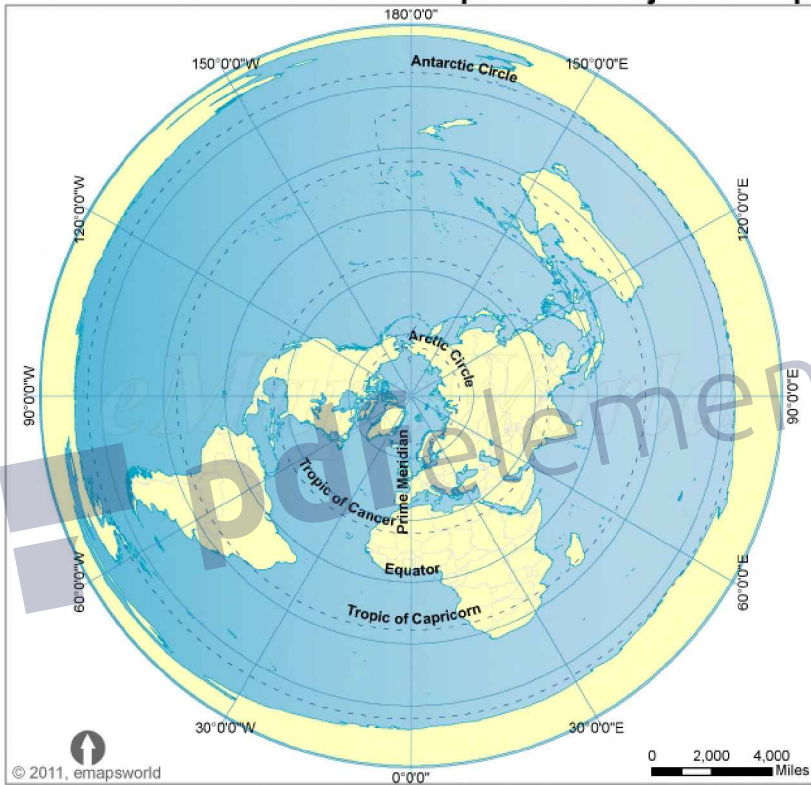

Below is a polar azimuthal equidistant standard map of the world from 1892.



Obviously, the globe model presents the traveler with a significantly different configuration than does the flat earth model, particularly in the so-called "southern hemisphere." The discrepancy between the reality of a flat earth and the myth of a

globe have found many a seafarer off course as they traversed the south seas. Samuel Rowbotham explains the dangers of the false charts based upon a globe model:

In the southern hemisphere, navigators to India have often fancied themselves east of the Cape when still west, and have been driven ashore on the African coast, which, according to their reckoning, lay behind them. This misfortune happened to a fine frigate, the Challenger, in 1845.³⁸⁰

How came Her Majesty's Ship Conqueror, to be lost? How have so many other noble vessels, perfectly sound, perfectly manned, perfectly navigated, been wrecked in calm weather, not only in a dark night, or in a fog, but in broad daylight and sunshine--in the former case upon the coasts, in the latter, upon sunken rocks--from being 'out of reckoning,' under circumstances which until now, have baffled every satisfactory explanation.³⁸¹

Rowbotham explains how the British ship Challenger completed the circuit of the southern region, indirectly, to be sure, circumnavigating Antarctica. The approximate circumference of Antarctica is supposed to be approximately 14,460 statute miles on the globular earth model. However, the Challenger spent three years and traversed nearly 69,000 miles. That is a distance that would have allowed the ship to circle Antarctica over 4 times if the earth were in fact a globe. The 69,000 mile long journey around the circumference of the earth that is Antarctica, however, is perfectly explained by a flat earth.³⁸²

Rowbotham quotes from voyagers, who found that their charts, which used a globular earth model, almost always put them

off course in the south seas. "We found ourselves every day from 12 to 16 miles by observation in advance of our reckoning."³⁸³ Another southern seafarer stated: "By our observations at noon we found ourselves 58 miles to the eastward of our reckoning in two days."³⁸⁴

The spherical earth charts did not account for the expanse of distance between the lines of longitude the further south one travels on a flat earth. Consequently, the mariners' true position on the earth, determined by using celestial navigation and a chronometer, was found to be off by several degrees from the position on the chart that was plotted using dead reckoning. One mariner detailed the distance that the erroneous charts, which assumed a globular earth, put them off course in the south seas.

February 11th, 1822, at noon, in latitude 65.53. S. our chronometers gave 44 miles more westing than the log in three days. On 22nd of April (1822), in latitude 54.16. S. our longitude by chronometers was 46.49, and by D.R. (dead reckoning) 47° 11': On 2nd May (1822), at noon, in latitude 53.46. S., our longitude by chronometers was 59° 27', and by D.R. 61° 6'. October 14th, in latitude 58.6, longitude by chronometers 62° 46', by account 65° 24'. In latitude 59.7. S., longitude by chronometers was 63° 28', by account 66° 42'. In latitude 61.49. S., longitude by chronometers was 61° 53', by account 66° 38'.³⁸⁵

The skippers of the ships in the south seas could only guess that the discrepancies between their dead reckoning plotted on their charts and their true positions, confirmed by precise chronometers and sextants, was due to the currents. Rowbotham explains, however, that currents could not possibly account for the navigation errors, because the errors in the navigation were

manifested regardless of whether the ships were travelling east or west.

The commander of the United States exploring expedition, Lieutenant Wilkes, in his narrative, says that in less than 18 hours he was 20 miles to the east of his reckoning in latitude $54^{\circ} 20' S$. He gives other instances of the same phenomenon, and, in common with almost all other navigators and writers on the subject, attributes the differences between actual observation and theory to currents, the velocity of which, at latitude $57^{\circ} 15' S$., amounted to 20 miles a day. The commanders of these various expeditions were, of course, with their education and belief in the earth's rotundity, unable to conceive of any other cause for the differences between log and chronometer results than the existence of currents. But one simple fact is entirely fatal to such an explanation, viz., that when the route taken is east or west the same results are experienced. The water of the southern region cannot be running in two opposite directions at the same time; and hence, although various local and variable currents have been noticed, they cannot be shown to be the cause of the discrepancies so generally observed in high southern latitudes between time and log results. The conclusion is one of necessity--is forced upon us by the sum of the evidence collected that the degrees of longitude in any given southern latitude are larger than the degrees in any latitude nearer to the northern centre; thus proving the already more than sufficiently demonstrated fact that the earth is a plane, having a northern centre, in relation to which degrees of latitude are

concentric, and from which degrees of longitude are diverging lines, continually increasing in their distance from each other as they are prolonged towards the great glacial southern circumference.³⁸⁶

Below is a map depicting the path of the sun and moon. They would progress in their path from the Tropic of Cancer for the summer months in the north (the winter months in the south) to the Tropic of Capricorn for the winter months in the north (the summer months in the south).

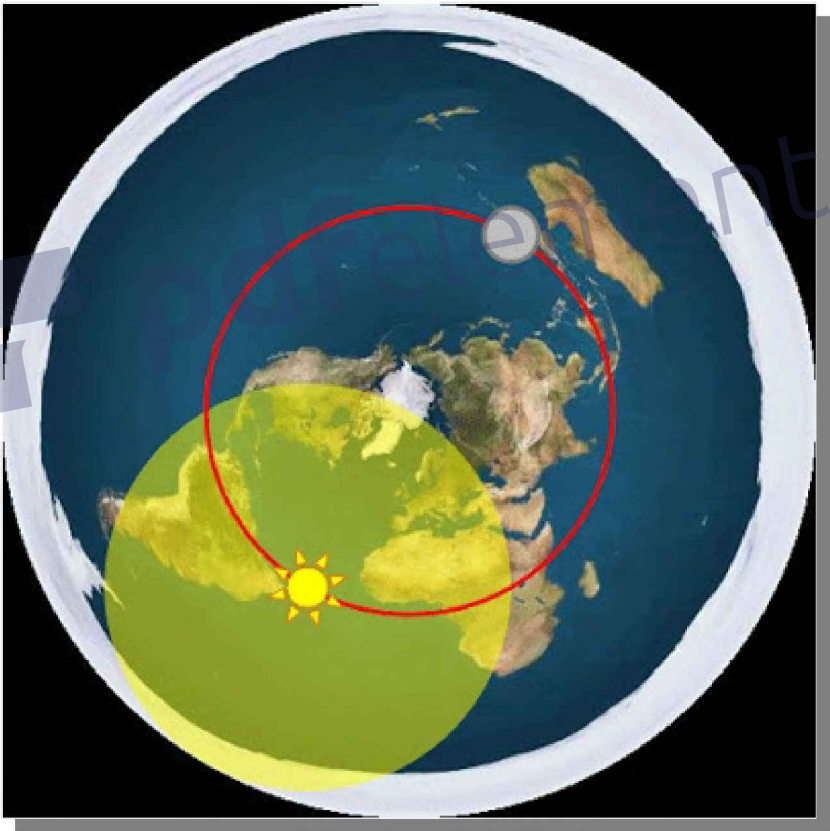

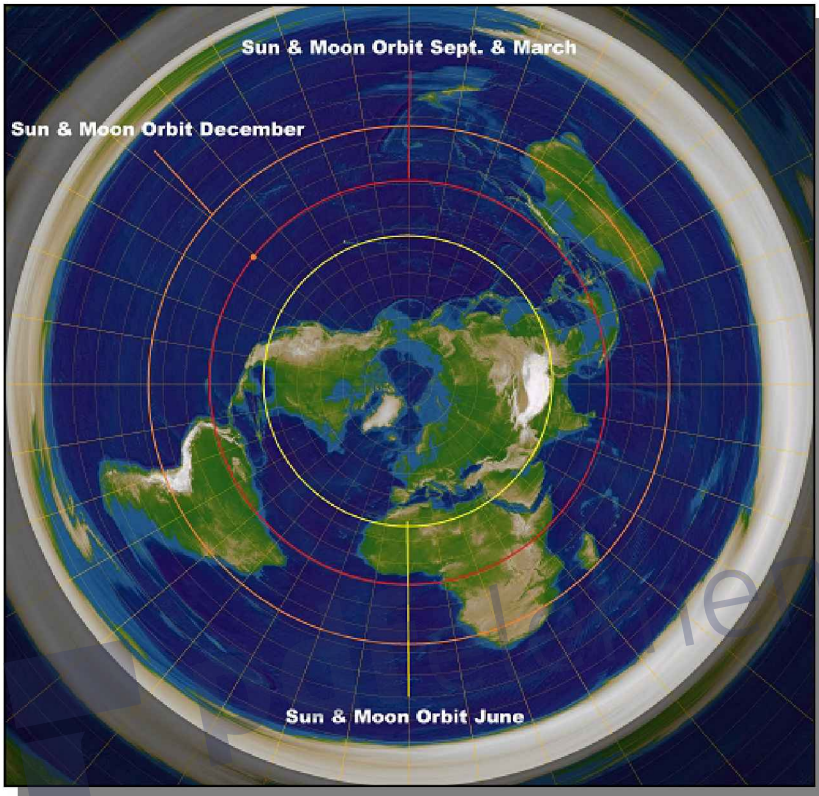

The governments of the world want the masses to believe that the world is round. However, when governments want to know how to address issues on the real configuration of the world, they reference a polar azimuthal equidistant flat earth map. Indeed, the U.S. Military employs hundreds of soldiers and civilians in producing accurate maps of areas of deployment. Those maps are almost never made public. Below is a frame from an official video tour of the White House Situation Room, published by the White House and posted on the internet, showing a polar projection of an azimuthal equidistant map in the White House Situation Room.³⁸⁷ When it really counts, the U.S. Government wants to know the

real configuration of the earth: a flat earth.

Remove Watermark Now



Polar Azimuthal Equidistant Map
in the White House Situation Room

pdfelement

22

What Does the Bible Say?

It has been the accepted dogma of so-called “science” that the earth is a globe spinning faster than the speed of sound as it orbits the sun at approximately 80 times faster than the speed of a rifle bullet. The sun, in turn, is supposed to be hurtling through the Milky Way galaxy at more than 500 times faster than the speed of a rifle bullet. The Milky Way galaxy is, itself, alleged to be racing through space at a speed that some scientists claim is over 1,000 times faster than the speed of a rifle bullet.

God’s word, however, states that the earth is fixed and does not move. “Fear before him, all the earth: the world also shall be stable, that it be not moved.” (1 Chronicles 16:30) Indeed, the earth cannot be moved. “The LORD reigneth, he is clothed with majesty; the LORD is clothed with strength, wherewith he hath girded himself: the world also is stablished, that it cannot be moved.” (Psalms 93:1).

Notice that the immovable earth is closely associated with the praise and glory of God Almighty. They are inseparable concepts. In Psalms 93:1 we read that the LORD is clothed with majesty and strength, just as the world is stable and cannot be moved. If the earth is movable, then it impeaches the majesty and

strength of God. Psalms 104.1-5 makes it clear that God laid the foundations of the earth and stretched forth the heavens just as he is clothed with honor and majesty. The concepts of God's majesty and a stable immovable earth are inseparable. If the earth moves and spins, then the God of the bible cannot exist. However, a stable immovable earth confirms the existence of God.

Bless the LORD, O my soul. O LORD my God, thou art very great; thou art clothed with honour and majesty. Who coverest thyself with light as with a garment: who stretchest out the heavens like a curtain: Who layeth the beams of his chambers in the waters: who maketh the clouds his chariot: who walketh upon the wings of the wind: Who maketh his angels spirits; his ministers a flaming fire: Who laid the foundations of the earth, that it should not be removed for ever. (Psalms 104:1-5)

The very worship of the Lord is closely associated with an immovable earth. In fact, Christians are called upon to tell the heathen that the LORD reigns and we are to also tell them that the world shall not be moved.

O worship the LORD in the beauty of holiness: fear before him, all the earth. Say among the heathen that the LORD reigneth: the world also shall be established that it shall not be moved: he shall judge the people righteously. (Psalms 96:9-10)

Why are Christians not telling the heathen that the earth shall not be moved today? Because of the pride of life. Christians today are afraid of being labeled a "flat earther," which the devil and his minions have propagandized people to associate with being ignorant. It is a time honored practice of the devil to use the

sinful flesh as a lever to quiet Christians.

There are many Christian “scientists” who try to ease their conscience by accommodating the lies of “science” with the truth of the gospel. They take the view that the bible is true about everything, except scientific “facts.” One example is Francis Collins, M.D., Ph.D., who is a prominent evangelical Christian geneticist, who is the director of the National Institute of Health and believer in the “science” of evolution. Dr. Collins stated that he reads and trusts the bible about theological truths. He, however, suggests that discoveries in science are just as authoritative as the bible and reconciles the conflicts between the bible and so-called “science” by claiming that the bible was not intended to be a textbook of science. He claims that the bible is only a book about the nature of God and man.³⁸⁸

God contradicts charlatans like Collins. God’s word is true regarding all things, both in theology and science. **“I esteem all thy precepts concerning all things to be right.”** (Psalms 119:128) Indeed, Jesus stated that if one does not believe him about the earthly things that he explained (i.e., true science), they could not believe him regarding theological truths. “If I have told you earthly things, and ye believe not, how shall ye believe, if I tell you of heavenly things?” (John 3:12)

Jesus maintained the truth of the Genesis account of creation, which was written by Moses. Jesus told the Jews that if they did not believe Moses, they would not believe him. “For had ye believed Moses, ye would have believed me: for he wrote of me. But if ye believe not his writings, how shall ye believe my words?” (John 5:46-47) The King James Holy Bible titles the first book of the bible as “The First Book of Moses, Called Genesis.” Where did Moses write about Jesus? In Genesis 3:15 and Genesis 22:18.

The Jews, however, rejected Moses and went after their

own traditions, which have been memorialized in the Talmud and Kabbalah. The Jews do not believe Moses, therefore they do not believe Jesus. One cannot believe the gospel of Jesus Christ without believing the creation account in Genesis. A Christian who says he believes Jesus Christ but rejects the creation account believes in a different Jesus. “For if he that cometh preacheth another Jesus, whom we have not preached, or if ye receive another spirit, which ye have not received, or another gospel, which ye have not accepted, ye might well bear with him.” (2 Corinthians 11:4) All of (not just some of) God’s words are pure truth. John 17:17.

We are admonished not to be seduced by the world and its lusts. The desire for the love of the world is what has silenced the entire Christian church on the issue of heliocentrism.

Love not the world, neither the things that are in the world. If any man love the world, the love of the Father is not in him. For all that is in the world, the lust of the flesh, and the lust of the eyes, and the pride of life, is not of the Father, but is of the world.” (1 John 2:15-16)

God “laid the foundations of the earth, that it should not be removed for ever.” Psalms 104:5. What kind of foundation is there in a spinning earth careening through space? Such a spinning, moving earth cannot be said to have any foundation. If there is no foundation, there is no God, since God stated he laid the foundations of the earth. In fact, the heavens prove the existence of God, as they demonstrate his skill as the creator. In Psalms 19:1 it states that the heavens declare the glory of God and the firmament shows his handiwork. Part of the glory of God and his handiwork is the fact that the earth is stationary and the sun travels in a circuit over the earth.

The heavens declare the glory of God; and the

firmament sheweth his handywork. Day unto day uttereth speech, and night unto night sheweth knowledge. There is no speech nor language, where their voice is not heard. Their line is gone out through all the earth, and their words to the end of the world. In them hath he set a tabernacle for the sun, Which is as a bridegroom coming out of his chamber, and rejoiceth as a strong man to run a race. His going forth is from the end of the heaven, and **his circuit unto the ends of it:** and there is nothing hid from the heat thereof. (Psalms 19:1-6)

It is the sun that travels in a circuit, not the earth. What is a circuit? It is a continuous circular route that starts and ends in the same place. Some might argue that the circuit of the sun is the sun's revolutions around the Milky Way galaxy. The problem with that interpretation is that Psalm 96:10 states "the world also shall be established that it shall not be moved." If the earth cannot be moved, yet the sun is careening through space, that means that the sun would be flying away from the earth.

It is God who created the heavens and the earth, and he had a purpose for doing so. It was to be inhabited by man, whom he created in his image.

For thus saith the LORD that created the heavens;
God himself that formed the earth and made it; he
hath established it, he created it not in vain, he
formed it to be inhabited: I am the LORD; and
there is none else. (Isaiah 45:18)

God's creation of heaven and earth is part and parcel of his creative powers each day when he forms each person in the womb. If people lose sight of God as creator of all things, then any sin, including abortion can be justified. It is important for people

to understand the nature of God's creation, because it reveals his character. In Isaiah 44:24 God states that he alone stretched forth the heavens and spread abroad the earth. A ball is not spread out. You spread out things that are flat, like a flat bed spread. God spread out the earth and he stretched forth the heavens above the earth.

Thus saith the LORD, thy redeemer, and he that formed thee from the womb, I am the LORD that maketh all things; that stretcheth forth the heavens alone; that spreadeth abroad the earth by myself. (Isaiah 44:24)

The account of creation in Genesis refutes the commonly held view of a spherical earth that is surrounded by an endless vacuum of "space." In Genesis 1:6 we read that "God said, Let there be a firmament in the midst of the waters, and let it divide the waters from the waters." A firmament is something that is hard. Indeed, in Job the firmament is likened to a strong, molten looking glass. "Hast thou with him spread out the sky, which is strong, and as a molten looking glass?" (Job 37:18) A looking glass is a highly polished reflective surface.

The firmament divides the waters, which means that there is water above the firmament in heaven. Indeed, all one needs to do is look skyward to see the blue water that is above the firmament. The blue sky is not the atmosphere as claimed by scientists; the blue sky is the water above the canopy of the firmament. God placed the sun, moon, and stars in the firmament.

And God said, Let there be lights in the firmament of the heaven to divide the day from the night; and let them be for signs, and for seasons, and for days, and years: And let them be for lights in the firmament of the heaven to give light upon the earth: and it was so. (Genesis

1:14-15)

When God flooded the earth he opened the windows of heaven to let out some of the water that was above the firmament.

In the six hundredth year of Noah's life, in the second month, the seventeenth day of the month, the same day were all the fountains of the great deep broken up, and the windows of heaven were opened. (Genesis 7:11)

God formed the foundation of the earth from the beginning. "Of old hast **thou laid the foundation of the earth:** and the heavens are the work of thy hands." (Psalms 102:25) God laid the foundation of earth immovable forever. "Who laid the foundations of the earth, that it should not be removed for ever." (Psalms 104:5) Please note that God laid the foundations of the earth, which does not at all suggest a globular earth. "**Mine hand also hath laid the foundation of the earth,** and my right hand hath spanned the heavens: when I call unto them, they stand up together." (Isaiah 48:13) The foundation is stated to be pillars. "He raiseth up the poor out of the dust, and lifteth up the beggar from the dunghill, to set them among princes, and to make them inherit the throne of glory: for **the pillars of the earth are the LORD'S, and he hath set the world upon them.**" (1 Samuel 2:8) What is the foundation of the earth? One could infer that it is the seas. "The earth is the LORD'S, and the fulness thereof; the world, and they that dwell therein. **For he hath founded it upon the seas, and established it upon the floods.**" (Psalms 24:1-2) Indeed, God states that he stretched out the heavens over the earth, which suggests a flat earth. "I have made the earth, and created man upon it: I, even my hands, **have stretched out the heavens,** and all their host have I commanded." (Isaiah 45:12) God has repeatedly referred to the earth as being founded upon water. "To him that **stretched out the earth above the waters:** for his mercy endureth for ever." (Psalms 136:6) Notice that the earth is "stretched out"

above the waters. A flat earth could be said to be stretched out, but such an expression would preclude a globular earth.

Nowhere in the bible does God state that the earth is a globe. In fact, God expressly states that the face of the earth is a circle. **“It is he that sitteth upon the circle of the earth, and the inhabitants thereof are as grasshoppers; that stretcheth out the heavens as a curtain, and spreadeth them out as a tent to dwell in:”** (Isaiah 40:22) A circle is two-dimensional and flat. That does not mean that the earth is two dimensional, as the earth certainly has depth. Rather, it means that the earth has a face that is a flat circle. Amos 9:6. It is “the circle of the earth.” A globe, on the other hand, is a three dimensional ball. Isaiah knew the difference between a ball and a circle. See Isaiah 22:18. If Isaiah meant ball in Isaiah 40:22, he would have said ball. He didn’t say ball, because the earth is not a ball. There can be no confusion here. God is stating that the face of the earth is a flat circle and the heavens are spread like a tent over that circle.

In the bible, it states in reference to wisdom: “I was there: when he set a compass upon the face of the depth.” (Proverbs 8:27) Notice God set a compass upon the face of the depth. What does compass mean in that context? Certainly, a compass is a directional instrument, but the word compass means more than that. Compass also means a circular boundary; the limit or boundary of a space, and the space included; encircle; to surround; to inclose on all sides; a circular course.³⁸⁹ A compass is a flat circular boundary. In Proverbs 8:27 we have God encircling the seas with a boundary. That can only happen on a flat earth. The boundary of the seas is the ice rim of Antarctica. The globular myth is that one can circumnavigate the globe by going around Antarctica, because it is believed to be a continent in the southern most part of a spherical earth. The globular earth myth does not have a circular boundary for the seas, as stated in Proverbs 8:27. “Let God be true, but every man a liar.” (Romans 3:4)

God has described the earth as his footstool. Thus saith the LORD, **The heaven is my throne, and the earth is my footstool:** where is the house that ye build unto me? and where is the place of my rest?" (Isaiah 66:1) Footstools are not spherical.

God states that he looks upon all the inhabitants of the earth from one location, his place of habitation in heaven. "From the place of his habitation he looketh upon all the inhabitants of the earth." (Psalms 33:14) It is not possible for God to look upon all of the inhabitants of the earth on a globe from one location; those on the backside of the earth would be hidden from view. People might argue that God is all powerful and therefore can do anything. Yes, but Satan is not all powerful. In Matthew 4:8 and Luke 4:5, the devil took Jesus up to a high mountain and showed him all the kingdoms of the world. The devil did not take Jesus around the world on a tour of the kingdoms. The devil showed him all of the kingdoms from one point on a high mountain. How could the devil have shown all the kingdoms of the world from a single spot on a high mountain on a globular earth? Such an event could only be done on a flat earth.³⁹⁰

Matthew 4:8: "Again, the devil taketh him up into an exceeding high mountain, and sheweth him all the kingdoms of the world"

Luke 4:5: "And the devil, taking him up into an high mountain, shewed unto him all the kingdoms of the world in a moment of time."

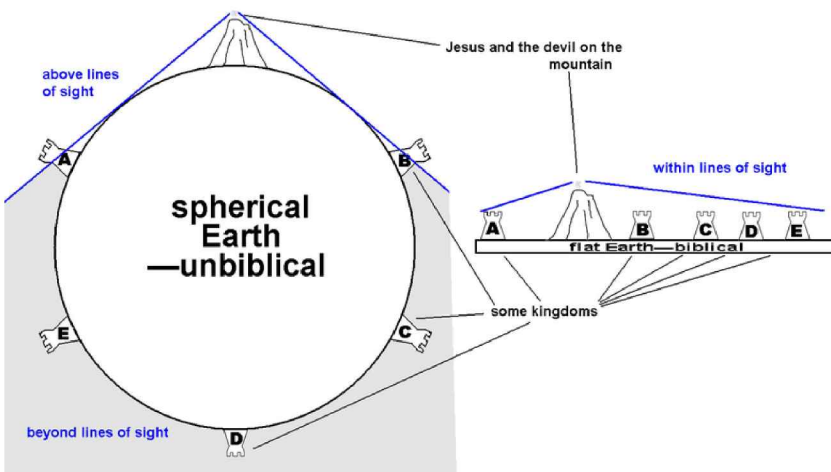

When Jesus returns to earth, everyone will see him in the sky. “Behold, he cometh with clouds; and **every eye shall see him**, and they also which pierced him: and all kindreds of the earth shall wail because of him. Even so, Amen.” (Revelation 1:7) Jesus will return physically “with clouds.” That is a fulfillment of the prophecy in Mark 13:26 that Jesus will physically return “in the clouds.” That would only be possible on a flat earth. If the earth were a globe those on the back side of the globe could not see him. Some may argue that the prophecy of Jesus’ return in Revelation 1:7 would be worked out by God in some miraculous way so that everyone on the supposed spherical earth will see his return. That view is impeached by Acts 1:9-11, where God makes clear that Jesus will return to earth from heaven just as he ascended from earth to heaven. The only way that every eye on earth could see Jesus’ descent from heaven in that manner is on a flat earth.

And when he had spoken these things, while they beheld, he was taken up; and a cloud received him out of their sight. And while they looked stedfastly toward heaven as he went up, behold, two men stood by them in white apparel; Which also said, Ye men of Galilee, why stand ye gazing up into heaven? this same Jesus, which is taken up from you into heaven, shall so come in like manner as ye have seen him go into heaven. (Acts 1:9-11)

God describes the face of the earth as a circle. He also describes the earth as having four corners. “And after these things I saw four angels standing on the **four corners of the earth**, holding the four winds of the earth, that the wind should not blow on the earth, nor on the sea, nor on any tree.” Revelation 7:1. See also Isaiah 11:12. While the word corner brings to mind a sharp angle, that is not its only meaning. A corner is not just where two

edges meet. Corner also means parts, or regions. Indeed, not all corners are sharp angles; we often refer to driving on a rounded curve in the road as going around a corner. A corner is also defined as “indefinitely any part; a part. ... The end, extremity or limit.”³⁹¹ The following phrases given in the American Dictionary of the English Language are examples of how corner means more than the place where two edges meet: “They searched every corner of the forest. They explored all corners of the country.”³⁹² It also has the meaning of “direction” or “quarter.”³⁹³ It could also be “a small area away from the center, especially one that is quiet, peaceful, or secret.”³⁹⁴ The Merriam Webster Dictionary defines corner as “a private, secret, or remote place,”³⁹⁵ and gives that example of “a quiet corner of New England” and “to every corner of the earth”³⁹⁶

The context of Revelation 7:1 suggests that corners mean remote regions of the earth. Indeed, God refers to the ends of the earth. There are no “ends” to a globular earth.

He hath made the earth by his power, he hath established the world by his wisdom, and hath stretched out the heaven by his understanding. When he uttereth his voice, there is a multitude of waters in the heavens; and he **causeth the vapours to ascend from the ends of the earth:** he maketh lightnings with rain, and bringeth forth the wind out of his treasures. Jeremiah 51:15-16.
See also Jeremiah 16:19.

Indeed, the context of corners suggests that God in fact means ends of the earth. Elsewhere in the bible, God describes the lightning going out to the ends of the earth. “He directeth it under the whole heaven, and his lightning unto **the ends of the earth.**” (Job 37:3) God looks out over the whole earth at once and sees to the ends of the earth; again, that suggests a flat earth. “For he looketh to **the ends of the earth,** and seeth under the whole

heaven.” (Job 28:24) Modern science has replaced God’s above of heaven with the myth of the empty vacuum of space, thus suggesting that there is no heaven and there is no God. If there is only an empty vacuum of space, that means that God cannot be above us walking in the circuit of heaven. “Thick clouds are a covering to him, that he seeth not; and he walketh in the circuit of heaven.” (Job 22:14)

In Daniel we read of his vision of a tree that was so high that it could be seen to the end of the earth. There is no end to the earth on a globe; such a tree could only be seen at the end of a flat earth. “The tree grew, and was strong, and the height thereof reached unto heaven, and the sight thereof to the end of all the earth:” (Daniel 4:11)

All builders know what it is to “snap a line” when building to ensure that objects are laid even and level. When snapping a line, one stretches a cord that is coated with chalk and it is snapped against the surface of whatever is being constructed. The line leaves a perfectly straight chalk line between the two points of the line. You cannot stretch a line on a ball. Notice that in Job 34 God stretched the line upon the earth, which suggests a flat earth. Notice also how God takes hold of the ends of the earth. A globe does not have ends that can be held.

Where wast thou when I laid the **foundations of the earth?** declare, if thou hast understanding. Who hath laid the measures thereof, if thou knowest? or who hath **stretched the line upon it?** Whereupon are the **foundations thereof fastened?** or who laid the corner stone thereof; When the morning stars sang together, and all the sons of God shouted for joy? Or who shut up the sea with doors, when it brake forth, as if it had issued out of the womb? When I made the cloud the garment thereof, and thick darkness a

swaddlingband for it, And brake up for it ^{my} decreed place, and set bars and doors, And said, Hitherto shalt thou come, but no further: and here shall thy proud waves be stayed? Hast thou commanded the morning since thy days; and caused the dayspring to know his place; **That it might take hold of the ends of the earth, that the wicked might be shaken out of it?**” (Job 38:4-13)

The bible prophesies that the stars will fall to the earth. “And the stars of heaven fell unto the earth, even as a fig tree casteth her untimely figs, when she is shaken of a mighty wind.” (Revelation 6:13) The prophecy of the stars falling to earth would be ridiculous if the stars were large suns millions of light years away. Of course, that is the point of modern cosmology, to refute the truth and authority of the bible. If the modern cosmology were correct, a single star would engulf the earth if it struck the earth. Modern so-called science serves to undermine the word of God.

God pours water upon the “face of the earth.” “It is he that buildeth his stories in the heaven, and hath founded his troop in the earth; he that calleth for the waters of the sea, and poureth them out upon **the face of the earth**: The LORD is his name.” (Amos 9:6) Everyone knows that when speaking of objects, “face” is the flat visible side of an object. For example, we commonly speak of the face of a clock. Never is a ball or globe referred to as having a face. We would never refer to a baseball as having a face. Indeed, it cannot have a face, it is round. Face implies the front of an object. Persons have faces, which is because a person’s face is considered the front of his head, which is not at all like the back of his head. A spherical earth cannot have a face, because there is no front to a globe. However, both God and man refer to the face of the earth, which denotes that the earth is flat. “Thou sendest forth thy spirit, they are created: and thou renewest **the face of the earth**. (Psalms 104:30)

Joshua 10:12-13 poses a real problem for the Christians who believe in a heliocentric model of a rotating earth orbiting around the sun. In Joshua 10:1-13, God caused the sun and the moon to stand still. In order for Christians to hold to heliocentricity, they must necessarily call God a liar, because God moved Joshua to give a command to both the sun and the moon to stand still in Joshua 10:12-13; whereby God stopped both the sun and moon in their motion across the sky.

Then spake Joshua to the LORD in the day when the LORD delivered up the Amorites before the children of Israel, and he said in the sight of Israel, Sun, stand thou still upon Gibeon; and thou, Moon, in the valley of Ajalon. And the sun stood still, and the moon stayed, until the people had avenged themselves upon their enemies. Is not this written in the book of Jasher? So the sun stood still in the midst of heaven, and hasted not to go down about a whole day. (Joshua 10:12-13)

God states clearly in the passage that the sun stood still. The passage does not say that the earth stopped spinning. “Scientists” claim that the earth is spinning at 1,000 miles per hour at the equator and that motion of the earth accounts for the path of the sun across the sky. If that were the case, the event in Joshua could never have happened. Any vehicle coming to a sudden stop at 1,000 miles per hour would kill all the passengers aboard. It would be a bloody mess. The same would happen on a supposedly spinning earth. A sudden stop of the supposed spin of the earth would have killed every living thing on earth. God would have killed the very army of Israel that he was helping. That makes no sense.

It was not the earth that stopped spinning. God did just what he said he did; he caused the sun to stop and stand still in the sky. God did not command the earth to stop spinning. The passage

states that God commanded the “Sun, stand thou still.” The sun obeyed God’s command and “the sun stood still.” Indeed, God states that it “hasted not to go down about a whole day.” That means that ordinarily the sun would be hastening to go down, but in this particular case it did not. The sun is ordinarily in motion, coming up and going down. On that day, God stopped the sun’s usual motion in the sky. To suggest otherwise is to call God a liar.

God’s intention in helping Israel was to stop the sun. Stopping the moon was not helpful to Israel. However, once God stopped the sun, he also stopped the moon, because God wanted to keep the motions of the sun and moon synchronized. The synchronization of the sun and moon is part of God’s creation. God made the sun and moon to be “lights in the firmament of the heaven to divide the day from the night; and let them be for signs, and for seasons, and for days, and years.” Genesis 1:14. He made the sun to rule the day and the moon to rule the night. Genesis 1:15-16. In order to keep that purpose intact, once God stopped the sun, it was necessary for God to also stop the moon.

Notice also that God ordered the sun to stand still upon Gibeon and the Moon, to stand still in the valley of Ajalon. The sun could not be said to be “upon Gibeon” if the sun were more than 100 times larger than a spherical earth and 93 million miles away in distant space, as it is portrayed under the heliocentric model. Furthermore, the heliocentric model puts the moon 240,000 miles away from a globular earth in distant space, which would preclude it from being “in the valley of Ajalon” as stated by God in Joshua 10:12-13. The sun and moon both must be much smaller than and closer to the flat earth in order to stand still over the areas in which they were located in Joshua, chapter 10.

“Scientists” acknowledge that it is the moon that moves over the earth. They wrongly opine that it is orbiting around earth. If God were stopping the sun by stopping the spin of the earth, the “scientific” view of the independently moving moon would

require that the moon keep moving in its supposed orbit around the spherical earth. But that is not what happened. God stopped the moon in that same way he stopped the sun; he stopped it in its usual circuit over a stationary, flat earth.

Satan has tried to muddy the waters so that Christians will not discover the truth of the flat unmovable earth at the center of God's creation. He must do this by having his minions publish corrupt versions of the bible. For example, corrupt bible versions like the New International Version (NIV) have been trotted out with corrupt passages that obfuscate the clarity of God's word. Despite the fact that God's word states clearly the earth is immovable, the new bible versions wish to change God's word to comport with what they believe is the "scientific fact" that the earth is rotating on its axis and at the same time orbiting around the sun. In 2 Kings God reveals a miracle he performed by making the shadow cast by the sun on Ahaz's sundial to reverse and go back ten degrees.

And Isaiah said, This sign shalt thou have of the LORD, that the LORD will do the thing that he hath spoken: shall the shadow go forward ten degrees, or go back ten degrees? And Hezekiah answered, It is a light thing for the shadow to go down ten degrees: nay, but let the shadow return backward ten degrees. And Isaiah the prophet cried unto the LORD: and he brought the shadow ten degrees backward, by which it had gone down in the dial of Ahaz. (2 Kings 20:9-11 AV)

Now, if you accept what God says in his word as true that the earth cannot be moved, it must have been the sun that went back ten degrees. In fact, in Isaiah 38:8, God reveals that is exactly what happened; the sun moved back ten degrees by which degrees it had already gone down. In order for the sun to return the ten degrees that it had already gone down, the sun must have been

moving across the sky in its ordinary path before its reversal. Hence, the earth is stationary and the sun revolves around the earth.

Because the New International Version (NIV) bible translators do not believe God's word, they have changed the passage in Isaiah 38:8 to state that "sunlight" went back ten steps on the "stairway," rather than what actually happened, that the sun itself returned ten degrees. Simply stated, they have changed the verse to comport with a heliocentric view of the universe.

AV

Behold, I will bring again the shadow of the degrees, which is gone down in the sun dial of Ahaz, ten degrees backward. **So the sun returned ten degrees, by which degrees it was gone down.** (Isaiah 38:8 AV)

NIV

I will make **the shadow cast by the sun go back the ten steps** it has gone down on the stairway of Ahaz. So the **sunlight went back the ten steps** it had gone down. (Isaiah 38:8 NIV)

By changing the passage to say that the sunlight went back instead of the sun, the NIV translators have removed the fact that the sun is moving and have allowed for an explanation that the earth reversed its rotation, thus causing the sunlight to move back. Furthermore, they have removed the miracle of the event entirely by stating that the shadow went back ten steps on a stairway, rather than ten degrees on a sundial. A shadow cast by a pillar can go up and then back down steps due to the ordinary travel of the sun across the sky, however, the shadow cast upon a sundial cannot move backwards unless the sun moves backwards.

The corrupt new bible versions have concealed from the reader the admonition to avoid the opposition of "science falsely so called." God clearly had in mind to warn his flock about heliocentricity and evolution. Instead, the reader of the new bible

versions is told to turn away from “what is falsely called **knowledge.**” There is no field of study called “knowledge,” but there is a whole discipline of study called “science.” The admonition to avoid so-called knowledge, therefore, has no real meaning. That is the point of the new bible versions: to strip the bible of any real guidance.

“O Timothy, keep that which is committed to thy trust, avoiding profane and vain babblings, and oppositions of **science** falsely so called.” 1 Timothy 6:20 AV (KJV) (emphasis added).

Timothy, guard what has been entrusted to your care. Turn away from godless chatter and the opposing ideas of what is falsely called **knowledge.** 1 Timothy 6:20 (NIV) (emphasis added).

The corrupt bible versions leave the reader without any warning against so-called science. Bible corruption is a centuries old pan by Satan. One of the early bible corruptions was the Roman Catholic Douay-Rheims Bible, which was an English translation of the Latin Vulgate. It was published in 1610, just in time to hop on the heliocentric bandwagon. That bible is given over entirely to following after “science falsely so called” in direct opposition to God’s admonition. In the passage at Isaiah 40:22, the Douay-Rheims bible changes the word “circle” to “globe,” to comport with the godless heliocentric model that has since become all the rage in “science falsely so called.”

“It is he that sitteth upon the **circle** of the earth, and the inhabitants thereof are as grasshoppers; that stretcheth out the heavens as a curtain, and spreadeth them out as a tent to dwell in.” Isaiah 40:22 AV (KJV) (emphasis added).

“It is he that sitteth upon the **globe** of the earth, and the inhabitants thereof are as locusts: he that stretcheth out the heavens as nothing, and spreadeth them out as a tent to dwell in. Isaiah 40:22 (Douay-Rheims Version) (emphasis added).

The Authorized (King James) Version (indicated by AV or KJV) of the bible is God’s word in the English language. The King James bible is a faithful English translation of God’s word that is largely based upon the authoritative Greek text known as the *Textus Receptus* (Received Text).

Every other English bible version, including the NIV, is corrupted by the servants of Satan. The NIV is based upon corrupted texts that were provided by the Roman Catholic Church. The two primary manuscripts that form the basis for the NIV, and indeed all modern English bibles, except for the Authorized (King James) Version, are the *Sinaiticus* and the *Vaticanus*. The manuscript *Sinaiticus*, which is often referred to by the first letter of the Hebrew alphabet, *Aleph*, is written in book form (codex) on velum.³⁹⁷ It contains many spurious books such as the Shepherd of Hermes, the Didache, and the Epistle of Barnabas.³⁹⁸ *Sinaiticus* was allegedly discovered by Constantine Tischendorf (1815-1874) in a waste basket in St. Catherine’s monastery on Mount Sinai in February of 1859.³⁹⁹ The monks of St. Catherine’s denied Tischendorf’s waste basket story. The waste basket story seems to have been a tale spun by Tischendorf to explain his mutilation of the codex and destruction of some leaves to conceal acrostics that would identify the author of the codex. *Sinaiticus* is covered with alterations that are systematically spread over every page and were made by at least ten different revisors.⁴⁰⁰ The alterations are

obvious to anyone who examines the manuscript.

Tischendorf was a nominal Protestant who had very close ties with the Roman Catholic hierarchy. He was welcomed at the Vatican by the pope in a private audience. Tischendorf also had meetings in the Vatican with the Vatican Librarian, Cardinal Angelo Mai (1782-1854), who, incidently, wrote an 1838 edition of the *Codex Vaticanus*.⁴⁰² *Sinaiticus* is not an ancient fourth century codex, as alleged by Tischendorf. Indeed, the author of *Sinaiticus* came forward and stated publically that it was in the early nineteenth century that he authored what became known as *Sinaiticus*.⁴⁰³ When Constantine Simonides (1820-1867), a renowned Greek scholar and paleographer, found out that the Greek manuscript of the bible that he wrote when he was at the Monastery of Saint Catherine was being promoted by Constantine Tischendorf as a fourth century manuscript, he refuted that claim. Simonides invited Tischendorf to a debate on the issue and challenged Tischendorf to bring *Sinaiticus* with him so that Simonides could demonstrate, with the public watching, where he had made unique markings that only the author of the document would know. Tischendorf agreed to the debate, but never showed up for the planned debate and never explained his absence. Tischendorf instead chose to use the media organs controlled by the Roman Catholic church to attack Simonides' character. To this day, Simonides is libelously accused of forgery, always with qualifiers like "allegedly" and "claimed to be," etc. What is almost never mentioned is that the allegations of forgery were actually litigated and Simonides was exonerated in a court of law.

It is a matter of public record, however, that a Greek Archimandrite (superior abbot) named Kallinikos, who was a resident of the St. Catherine's Monastery, came forward and verified that he was at St. Catherine's and witnessed, with his own eyes, Simonides writing *Sinaiticus*.⁴⁰⁴ Furthermore, Kallikos stated that he was at St. Catherine's Monastery and saw Tischendorf in possession of the manuscript that he recognized as

being the work of Simonides.⁴⁰⁵ Kallinikos accused Tischendorf of guile. Kallinikos stated that *Sinaiticus* was not an ancient text but was washed with lemon juice and herbs to lighten the text and make it appear to be an ancient text. He further accused Tischendorf of mutilating the codex written by Simonides.

The manuscript *Vaticanus*, often referred to by the letter “B,” originated in the Vatican library, hence the name.⁴⁰⁶ *Vaticanus* was first revealed in 1841; where the manuscript had been prior to that date is unclear.⁴⁰⁷ One thing is clear, the manuscript omits many portions of scripture which explain vital Christian doctrines. *Vaticanus* omits Genesis 1:1 through Genesis 46:28; Psalms 106 through 138; Matthew 16:2,3; Romans 16:24; the Pauline Epistles; Revelation; and everything in Hebrews after 9:14.⁴⁰⁸

It should not be surprising that the Vatican would produce a manuscript that omits the portion of the book of Hebrews which exposes the Mass as completely ineffectual and deletes Revelation chapter 17, which reveals Rome as the seat of “MYSTERY, BABYLON THE GREAT, THE MOTHER OF HARLOTS AND ABOMINATIONS OF THE EARTH.” It is notable that the two primary manuscripts used by the new bible versions were found in the care and custody of the Roman Catholic Church.

The *Vaticanus* and *Sinaiticus* manuscripts, which make up less than one percent of the existing ancient manuscripts, differ significantly from the Received Text that is the basis for the Authorized (King James) Version. *Vaticanus* omits at least 2,877 words; it adds 536 words; it substitutes 935 words; it transposes 2,098 words; and it modifies 1,132 words; making a total of 7,578 verbal divergences from the Received Text. *Sinaiticus* is an even worse corruption, having almost 9,000 divergences from the Received Text.⁴⁰⁹

Those corrupted texts (*Vaticanus* and *Sinaiticus*) became

the core of the modern Greek text that is the basis for all new bible versions, including the popular NIV. The personalities behind the new texts have an occult new age agenda. The compilers of the corrupted Greek text used in virtually all of the new bible versions were Brooke Foss Westcott and Fenton John Anthony Hort.⁴¹⁰

Westcott and Hort were nominal Protestants, but they were defacto Roman Catholics. Hort denied the infallibility of the Holy Scriptures, he did not believe in the existence of Satan, he did not believe in eternal punishment in Hell, nor did he believe in Christ's atonement.⁴¹¹ Hort, however, did believe in Darwin's theory of evolution, he believed in purgatory, and he also believed in baptismal regeneration.⁴¹² Hort hated the United States and wished for its destruction during the civil war, because he was a communist who hated all things democratic.⁴¹³

Westcott was equally Romish in his beliefs.⁴¹⁴ He, like Hort, rejected the infallibility of the Holy Scriptures.⁴¹⁵ He viewed the Genesis account of creation as merely an allegory.⁴¹⁶ He did not believe the biblical account of the miracles of Jesus.⁴¹⁷ He did, however, believe in praying for the dead and worshipping Mary.⁴¹⁸ Politically, Westcott was a devout Socialist.⁴¹⁹

Westcott and Hort were both necromancers who were members of an occult club called the "Ghostly Guild."⁴²⁰ Westcott also founded another club and named it "Hermes."⁴²¹ According to Luciferian H.P. Blavatsky, Hermes and Satan are one and the same.⁴²² Hort viewed evangelical Christians as dangerous, perverted, unsound, and confused.⁴²³

Assisting Westcott and Hort in creating the corrupt Greek revision was Dr. G. Vance, a Unitarian, who denied the deity of Christ, the inspiration of the Holy Scriptures, and the Godhead (Jesus Christ, God the Father, and the Holy Ghost).⁴²⁴ Jesuit Roman Catholic Cardinal Carlo Maria Martini, the prelate of Milan, was the editor of the corrupted Greek text.⁴²⁵ Martini

believed the occult new age philosophy that man can become divine.⁴²⁶ Remember, that is the very lie that Satan used to deceive Eve into eating the forbidden fruit: “ye shall be as gods.” Genesis 3:5.

The combined effect of having a corrupted text and then having that text interpreted using a free-form translation method known as dynamic equivalence has been that the NIV has 64,098 fewer words than the King James Bible.⁴²⁷ That is a 10% loss in the bible. That means that an NIV bible would have 170 fewer pages than a typical 1,700 page King James Bible.⁴²⁸ Let’s read what God thinks about such deletions of his holy words. “And if any man shall take away from the words of the book of this prophecy, God shall take away his part out of the book of life, and out of the holy city, and from the things which are written in this book.” Revelation 22:19. God takes the misuse of his name very seriously (Exodus 20:7), but it is even more serious to tamper with God’s word. [T]hou hast magnified thy word above all thy name. (Psalms 138:2)

The New International Version (NIV) is the most popular of the new bible versions. Reportedly, the NIV represents 45 % of all bibles sold.⁴²⁹ Dr. Virginia Mollenkott, the textual style editor for the NIV, is an admitted lesbian.⁴³⁰ The Chairman of the NIV Old Testament Committee, Dr. Woudstra, was considered to be sympathetic to the interests and practices of sodomites. The NIV chief editor vaunted the fact that the NIV showed that it is a great error to believe that in order to be born again one has to have faith in Jesus as Savior.⁴³¹

Rupert Murdoch owns the exclusive rights to the NIV.⁴³² The NIV is published by Zondervan, which is owned by Murdoch’s News Corporation.⁴³³ Murdoch’s News Corporation also owns Harper Collins, the publisher of Anton LaVey’s Satanic Bible. LaVey is the founder of The Church Of Satan. He is reputed to have been a Jew, whose real name was Howard Levey.

Both the Satanic Bible and the NIV Bible are featured on the Harper Collins sales website.⁴³⁴ “Can two walk together, except they be agreed?” (Amos 3:3 AV) LaVey’s book is an exoteric Satanic Bible, whereas the NIV is an esoteric Satanic Bible.

Time magazine called Murdoch one of the four most powerful people in the world, and for good reason; he has a media empire that includes Twentieth Century Fox, Fox Television, cable television providers, satellites, and newspapers and television stations throughout America, Europe, and Asia.⁴³⁵ The pope bestowed upon Murdoch the title of “Knight Commander of St. Gregory” for promoting the interests of the Roman Catholic Church.⁴³⁶

Defenders of the new bibles claim that the essential doctrines of the Christian Faith are expressed in the new bibles, even though they have been deleted or changed in many passages. James H. Son, author of *The New Athenians*, likened the logic of that argument to removing a stop sign from a busy street intersection and then justifying the removal because the other traffic signals in the city were left intact. Even though the sign only contained one word, that word is of critical importance to those who arrive at the intersection, just as each word in the Holy Bible is of critical importance to those who are reading it. The above example of the change in the passage in Isaiah 38:8, is just one of many examples of subtle changes in wording in the new bible versions used to change the true meaning of a passage.

God has made the point in the Holy Bible that **every word** of God is important. “And Jesus answered him, saying, It is written, That man shall not live by bread alone, **but by every word of God.**” (Luke 4:4 AV) Incidentally, the doctrine of Luke 4:4 is missing in the new bible versions. The NASB, which is another corrupt bible version based upon the *Vaticanus* and *Sinaiticus* manuscripts, leaves out the last clause and simply states: “And Jesus answered him, ‘it is written, MAN SHALL NOT LIVE

ON BREAD ALONE.” (Luke 4:4 NASB) The new versions leave the reader in ignorance as to what it is other than bread by which man lives: **“by every word of God.”** (Luke 4:4 AV)

And he humbled thee, and suffered thee to hunger, and fed thee with manna, which thou knewest not, neither did thy fathers know; that he might make thee know that man doth not live by bread only, but **by every word that proceedeth out of the mouth of the LORD doth man live.** (Deuteronomy 8:3 AV)

Every word of God is pure: he is a shield unto them that put their trust in him. (Proverbs 30:5 AV)

 pdfelement

23

Crushing Gravity

Under the heliocentric theory, the earth is spinning at approximately 1,000 miles per hour at the equator. The heliocentric scientists had a problem with their theory. How could they explain how people, animals, and things do not feel the centrifugal force of the spinning earth? Isaac Newton saved the day with his theory of Gravity. Newton's theory of gravity supposedly acts as a centripetal force working against the centrifugal force of the hypothesized spinning earth. Gravity is necessary on a spinning earth. But the earth is not spinning. On a stationary flat earth there is no centrifugal force. Since there is no centrifugal force, there can be no centripetal force. Hence, there is no gravity, because there is no need for the centripetal force of gravity on a flat, motionless earth.

Newton's theory of gravity is founded upon the premise that all objects are attracted to all other objects based upon their mass. Eric Dubay explains that this "law" of science has never been proven and cannot be observed.

[T]his magnetic-like attraction of massive objects gravity is purported to have can be found nowhere in the natural world. There is no

example in nature of a massive sphere or any other shaped-object which by virtue of its mass alone causes smaller objects to stick to or orbit around it! There is nothing on Earth massive enough that it can be shown to cause even a dust-bunny to stick to or orbit around it! Try spinning a wet tennis ball or any other spherical object with smaller things placed on its surface and you will find that everything falls or flies off, and nothing sticks to or orbits it. To claim the existence of a physical “law” without a single practical evidential example is hearsay, not science.⁴³⁷

Dubay is correct that gravity is not based upon science; gravity is like a heathen religious superstition. People believe it to be true, simply because the modern day witch-doctors, whom we call “scientists,” say so. Dubay further questions the magical qualities of gravity, where it is both a force of suspension, causing orbit, and at the same time a force of attraction, causing adhesion.

Now, even if gravity did exist, why would it cause both planets to orbit the Sun and people to stick to the Earth? Gravity should either cause people to float in suspended circular orbits around the Earth, or it should cause the Earth to be pulled and crash into the Sun! What sort of magic is “gravity” that it can glue people’s feet to the ball-Earth, while causing Earth itself to revolve ellipses round the Sun? The two effects are very different yet the same cause is attributed to both.⁴³⁸

According to the heliocentric model, the force of gravity at the equator is perfectly balanced against the centrifugal force of the spinning earth. All persons and objects are supposedly

perfectly balanced through gravity by their mass against the centrifugal force of the spinning earth to remain attached to the earth.

The problem with the gravitational theory is that according to that theory, the gravitational attraction to the earth by all persons and objects remains the same at all places on the earth. That means that the gravitational force at the North Pole is the same as the gravitational force at the equator. That poses a very real problem if the earth is spinning as alleged. That is because the centrifugal force decreases every mile toward the north pole, where the centrifugal force is ultimately reduced to zero, because the North Pole is the axis of the supposedly spinning earth. On a globe, as you travel north or south of the equator the circumference parallel to the equator becomes less. Consequently, the speed of the earth's spin at those more northern and southern latitudes from the equator would be slower than its speed of spin at the equator. For example, at the 45 degree north latitude, the earth's spin should be approximately 700 miles per hour. As the speed of the spin is reduced, so also is the correlative centrifugal force. The spinning earth and the mystical force of gravity are thus proven to be fictions.

Some will point out that objects do in fact have different weights at the equator and the North Pole. However, the difference is the reverse of what would be expected by the interaction between centrifugal force and the theory of gravity. Objects weigh a fraction of a percentage less at the North Pole than at the equator. The reason has to do with the fact that there is more atmospheric pressure the further one travels towards the equator, which causes the objects at the equator to weigh slightly more.

There is no such thing as gravity; gravity is not necessary on a flat earth. It is density that keeps objects from floating off the surface of the earth. People and objects are heavier than the air and therefore do not float off the ground. There are some gasses, of

course, that are lighter than air, and they float off the ground. Everyone has seen helium balloons float up in the air. Everyone understands that helium balloons are not some sort of anti-gravity devices; they float up in the air, because helium is lighter than air. Why do people not understand that apples fall from trees to the ground, not because of gravity, but because apples are denser than air? They believe in the mystical force of gravity, not because it has been proven true, but because they have been brainwashed into believing in it. Gravity does not exist. David Wardlow Scott explains:

Any object which is heavier than air and which is unsupported, has a natural tendency to fall by its own weight. Newton's famous apple at Woolsthorpe, or any other apple when ripe, loses hold of its stalk, and, being heavier than the air, drops as a matter of necessity, to the ground, totally irrespective of any attraction of the Earth. For, if such attraction existed, why does not the Earth attract the rising smoke which is not nearly so heavy as the apple? The answer is simple—because the smoke is lighter than the air, and, therefore, does not fall but ascends. Gravitation is only a subterfuge, employed by Newton in his attempt to prove that the Earth revolves round the Sun, and the quicker it is relegated to the tomb of all the Capulets, the better will it be for all classes of society. He draped his idol with the tawdry tinsel of false science, knowing well how to beguile the thoughtless multitude, for, with a little alteration of Byron's famous lines, it is still true that “[m]ortals, like moths, are often caught by glare. And folly wins success where Seraphs might despair.” Gravitation is a clever illustration of the art of hocus-pocus —heads I win, tails you lose;

Newton won his fame, and the people lost their senses.⁴³⁹

Gravity is more akin to a heathen religious belief, than it is a scientific theory. The “scientists” promoting gravity are like priests in a religious cult who have immortalized the man who first postulated gravity and follow the gravitational theory like some religious dogma.

The popular cult-like belief in gravity started with Sir Isaac Newton, who was a scientist who published his historic three-volume *Philosophiæ Naturalis Principia Mathematica* (The Mathematical Principles of Natural Philosophy) in 1687. In that book, Newton propounded his laws of motion and universal gravity. Newton is viewed by most in the scientific community as the seminal theoretician for the postulation of gravity.

Gravity is not supported by any scientific proof. What then was the source of the theory? S. Pancoast reveals that “the law of attraction and repulsion” in the Kabbalah was popularized under the name “gravity” by Isaac Newton.⁴⁴⁰ S. Pancoast states:

He [Pythagoras] was never permitted to declare publicly what he knew and believed, but taught his immediate pupils all the wonders of his philosophy, under the most binding obligation of secrecy. Pythagoras was forbidden to divulge this knowledge because it would reveal the law of attraction and repulsion, which constituted one of the great secrets of the sanctuary. Over a millennium later, Newton was led to the discovery of these forces by his studies of the Kabbalah.⁴⁴¹

What most do not know is that Isaac Newton was a religious mystic, who was very well studied in Judaism, and

Jewish texts. Aron Heller at the *Times of Israel* revealed that Newton “learned how to read Hebrew, scrolled through the Bible and delved into the study of Jewish philosophy, the mysticism of Kabbalah and the Talmud.”⁴⁴² Indeed, one writer has revealed that “7,500 pages of his [Newton’s] theological speculations, written in his own hand, are digitized at Israel’s national library at Hebrew University.”⁴⁴³

Who do we find in possession as the caretaker of Isaac Newton’s religious writings before they ended up in the National Library of Israel at Hebrew University in Jerusalem? It was a Zionist Jew, Abraham Yahuda, who obtained and maintained Newton’s theological writings. Yahuda scoured the earth to collect Isaac Newton’s writings on religion. Why was Yahuda so interested in the writings of Isaac Newton? Sarah Dry states that Yahuda “set about trying to purchase the Newton papers and wrote to [his wife] Ethel on July 28, ‘I am thrilled with the thought of acquiring them. He wrote a lot about the Bible and the Jews, about Cabbala and all sorts of Jewish questions.’”⁴⁴⁴

Yahuda was a contemporary of Albert Einstein and conferred with Einstein about Newton’s mystical religious writings.⁴⁴⁵ Einstein was also a Zionist Jew. Religiously, Einstein had much in common with Newton, as both Einstein and Newton believed in the reality of mysticism.⁴⁴⁶ Sarah Dry reveals this interesting fact about Einstein’s view of the publication of Isaac Newton’s theological writings:

In an interview with the historian of science I. B. Cohen that took place just two weeks before he died in 1955, Einstein spoke about, among other things, Newton’s theological writings. He said that it was significant that Newton had “sealed them all up in a box,” an indication, Einstein thought, of Newton’s awareness of how imperfect they were. Newton had “obviously” not

wanted to publish these speculations during his own lifetime. Einstein said, “with some passion,” that he hoped they would not now be published.⁴⁴⁷

Why was Einstein so passionately hopeful that Newton’s theological writings not be published? Because those writings would give up the game. Isaac Newton’s writings on theology would expose for the world the theological source for his theory of gravity, the Jewish Kabbalah. That is why Zionist Abraham Yahuda scoured the globe to collect Newton’s theological writings and why they are now safely stored in Jerusalem, at the National Library of Israel at Hebrew University. Dry further reveals:

Much as Stokes and Adams had before him, Einstein considered Newton’s private papers with an eye toward gleaning as much as possible of his method of discovery, what he refers to here as “the formative development” of his work in physics. Einstein implicitly links the process by which Newton developed his physics and his theology; by studying the one, we might gain an insight into the other.⁴⁴⁸

Einstein viewed Newton’s theological writings as “the formative development of his work in physics.” In a letter to Yahuda, Einstein stated the following about Isaac Newton’s theology:

Newton’s writings on biblical subjects seem to me especially interesting because they provide deep insight into the characteristic intellectual features and working methods of this important man. The divine origin of the Bible is for Newton absolutely certain, a conviction that stands in curious contrast to the critical skepticism that

characterizes his attitude toward the churches. From this confidence stems the firm conviction that the seemingly obscure parts of the Bible must contain important revelations, to illuminate which one need only decipher its symbolic language. Newton seeks this decipherment, or interpretation, by means of his sharp systematic thinking grounded on the careful use of all the sources at his disposal. While the formative development of Newton's lasting physics works must remain shrouded in darkness, because Newton apparently destroyed his preparatory works, we do have in this domain of his works on the Bible drafts and their repeated modification; these mostly unpublished writings therefore allow a highly interesting insight into the mental workshop of this unique thinker.⁴⁴⁹

Sir Isaac Newton's study of the Kabbalah is the real source for his theory of gravity. Marshall Hall explains that "[a]lthough Kabbalism is nearly always associated with Judaism, there are so-called 'Christian Kabbalists' such as Newton, Dee, Kepler, Shakespeare, Cardinal Nicolas of Cusa and a long list of Theosophists, Rosecrucians, Masons, Crowleyites, etc. All of these and more have been or now are promoters of Kabbalist mysticism."⁴⁵⁰ Hall states that "Newton, in short, insured the acceptance of the Copernican Model for two centuries with his arcane 'mathematical' concepts; concepts upon which others—Einstein through Sagan, et al—could erect today's Pharisee Cosmology."⁴⁵¹

Gershom Scholem is considered the founder of the modern, academic study of Kabbalah, and was the first Professor of Jewish Mysticism at the Hebrew University of Jerusalem. Scholem has stated that gravity is a force that has been known to the Jewish mystics from antiquity. This is certainly something that

Newton would have come across in his study of the Jewish Kabbalah. Gershom Scholem associated gravity “with the the final *Heh*, the *Shekhinah*, The Presence, the alchemical Earth, the Daughter in the divine family. Note the interesting connection between alchemical Earth and gravity, which rules our Earth!”⁴⁵²

Migene Gonzalez-Wippler, in her book, *The Kabbalah & Magic of Angels*, explains the foundational connection between the mysticism of the Jewish Kabbalah and the theory of gravity.

It [gravity] is the result of the union of cause and effect and the law of momentum. It keeps the universe in motion, and it also works with dark matter to maintain stars, planets and galaxies in harmonious balance. For that reason it is equated with *Tiphareth* [a/k/a *Tifereth*], the sixth sphere of the Tree of Life, which is the center of the Tree beneath *Kether*, the first sphere. *Tiphareth* is identified with the sun, which is at the center of the solar system and keeps its planets in steady orbits through gravitation.⁴⁵³

The Tree of Life, to which Gonzalez-Wippler refers, is a graphic depiction of the Jewish god, *Ein Sof*. It is not a coincidence that the *sefirot* are depicted in the

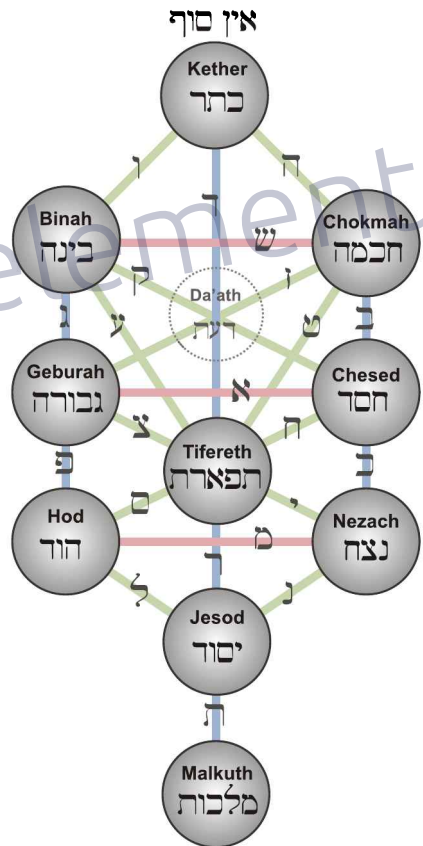

Figure 130: The Tree Of Life (*Ein Sof*) From the Jewish Kabbalah

Tree of Life as spheres. The Tree of Life (*Ein Sof*) is the foundational source for the “scientific” theory of gravity. For the myth of the spherical earth to be believed, there must be a force to explain why people and things do not fly off into space.

It is not necessary that gravity be proven or even make sense, as long as it is propped up by a facade of experts called “scientists.” Make no mistake about it, though, there is nothing scientific about gravity. It is pure heathenism, from the Jewish Kabbalah. The priest-scientists of the heliocentric religion tolerate no dissension from their religious dogma of gravity. According to Migene Gonzalez-Wippler, gravity “is equated with *Tiphareth* [a/k/a *Tifereth*], the sixth sphere of the Tree of Life.” As explained below, that means that gravity is not only an attribute of the Jewish god, *Ein Sof*, it is actually one of the god’s of the Kabbalah, in its own right.

The god of the Kabbalah, who is called *Ein Sof*, is made up of ten attributes (*sefirot*). Each *sefirah* (singular of *sefirot*) is not only designated as a particular trait of *Ein Sof* but is also an anthropomorphic part of that one god. In addition, each *sefirah* is either a god or a goddess in its own right. The first nine *sefirot* (plural of *sefirah*) are in turn divided evenly into three triads, containing three *sefirot* each and representing three major sections of the anthropomorphic parts of the mystical body of *Ein Sof*. The tenth *sefirah* is the *Shekinah* (a/k/a *Malkuth*), which is not part of the three triads.⁴⁵⁴

The Kabbalah describes the lower third triad of its heathen god (*Ein Sof*) as made up of three *sefirot*: 1) *Netzach* (Endurance/Victory), 2) *Hod* (Majesty/Glory), and 3) *Yesod* (Foundation).⁴⁵⁵ *Netzach* and *Hod* are the right and left legs of *Ein Sof*, and *Yesod* is *Ein Sof*’s phallus. According to the Kabbalah, the light and power of the *sefirot* are channeled through the phallic god *Yesod* to the last *Sefirah*, which is the *Shekinah* (a/k/a *Malkuth*).⁴⁵⁶ This phallic god is part of the blatantly erotic

interpretation of the Jewish god found in the *Kabbalah*. Rabbi Geoffrey W. Dennis in *The Encyclopedia of Jewish Myth, Magic, and Mysticism* explains: “The *Zohar* includes multiple interpretations built around the concept of God’s genitals.”⁴⁵⁸

Judaism is a phallic religion that was adopted by the Jews during their captivity in Babylon. Dan Cohn-Sherbok and Lavinia Cohn-Sherbok explain the development of the esoteric sexual meanings concealed within the orthodox Jewish liturgy:

Likewise, Phallic symbolism was employed in speculations about the ninth *Sefirah*, *Yesod*, from which all the higher *Sefirot* flowed into the *Shekinah* as the life force of the cosmos. In later centuries erotic terminology was used in the Hasidic works to describe movement in prayer which was depicted as copulation with the *Shekhinah*.⁴⁵⁹

The movement in prayer mentioned by Dan and Lavinia Cohn-Sherbok is called *shuckling* (a/k/a *shokeling* or *shoklen*). It is also called *davening*, which is simply a Yiddish word for prayer. The *shuckling* by Jews simulates the movement of copulation in sexual union with *Shekhinah*. *Shuckling* is symptomatic of the fact that Judaism is a phallic religion, which has liturgical practices and prayers with occult sexual meanings. Baal Shem Tov is considered the founder of Hasidic Judaism and a highly respected authority on Jewish theology. Baal Shem Tov stated that “Prayer is mating with the Shechinah.”⁴⁶⁰ The mating during prayer is manifested in swaying back and forth. Rabbi Eli Malon explains: “By ‘prayer,’ he [Baal Shem Tov] meant the literal swaying back and forth, suggestive of intercourse, that is customary of traditional Jewish prayer.”⁴⁶¹ The swaying is understood by Jews to signify copulation with the goddess *Shekinah*.⁴⁶² Former Jew, Nathaniel Kapner (a/k/a Brother Nathaniel), confirms the hidden meaning of the swaying by the Jews:

Watch closely how the rabbis thrust their pelvises and penises back and forth in a prescribed prayer movement called “davening” in which the Jew copulates with the ‘Shekinah’ in order to give birth to an erotic union with the ‘Ein Soph,’ the Kabbalistic masculine emanation of their false god.⁴⁶³

The occult sexual meaning behind *shuckling* is generally known among Jews, but is kept hidden from Gentiles. In 2013, Rabbi Michael Leo Samuel openly discussed in an article addressed to a Jewish audience in the *San Diego Jewish Herald*, the *shuckling* of Hasidic Jews in front of a Victoria’s Secret lingerie store. He wondered if the Hasidic Jews needed a visual aid for their *davening*. Samuel paraphrased the writings of Baal Shem Tov regarding the meaning of the swaying during Jewish prayer:

Prayer is zivug (coupling) with the Shechinah. Just as there is motion at the beginning of coupling, so, too, one must move (sway) at the beginning of prayer. Thereafter one can stand still, without motion, attached to the Shechinah with great deveikut (cleaving to God) As a result of your swaying, you can attain great bestirment. For you think to yourself: “Why do I move myself? Presumably it is because the Shechinah surely stands before me.” This will effect in you a state of great hitlahavut (enthusiasm; rapture).⁴⁶⁴ (parentheticals in original)

It seemed that Rabbi Samuel was upset that the Jews were *shuckling* in front of a Victoria’s Secret lingerie store, because it revealed too much about the occult meaning of the Jewish religion to the world. Rabbi Samuel stated: “With respect to the Hassidic Jews praying in front of the Victoria’s Secret lingerie store, they really believe that the world is not observing. They behave like a

young child who covers his ears and screams, thinking that nobody around him can hear him.”⁴⁶⁵

The powerful undercurrent of phallic worship infused into orthodox Judaism by the Kabbalah, includes the practice of sex magic.⁴⁶⁶ The sex magic is an offshoot of the secret doctrine in Judaism. It is a common doctrine found in secret societies, that the mystic can find redemption through an “heroic” willingness to do evil.⁴⁶⁷ The secret rabbinic doctrine is that evil can be redeemed by embracing it; there is a spiritual good in doing evil.⁴⁶⁸ That explains why Jesus said to the Jews: “Ye are of *your* father the devil, and the lusts of your father ye will do.” John 8:44. As is the case with the clerics of all phallic religions, there is rampant pederasty among Jewish clerics. Rabbinic pederasty is documented in this author’s book, *Solving the Mystery of BABYLON THE GREAT*.

Moshe Idel, in *Hasidism Between Ecstasy and Magic*, explains that “the concept of the descent of the *Zaddiq* [Jewish mystic or saint], which is better known by the Hebrew phrase, *Yeridah zorekh Aliyah*, namely the descent for the sake of the ascent, the transgression for the sake of repentance. . . . Much attention has been paid to this model because of its essential affinities with Zoharic and Lurianic Kabbalah . . . this model was a very important one in Hasidic thought.”⁴⁶⁹ That concept is the core belief in the system of “black magic.” The source of this secret doctrine of “black magic” is Babylon.⁴⁷⁰ The oldest texts for this Babylonian black magic in Judaism are the texts *Sifrei h-Iyyun*, *Sefer ha-Bahair*, and the *Hikoth Yesirah*, which is also known as the *Sefer Yetzirah*.⁴⁷¹

The *Yesod* (*Jesod*) unites the *Shekinah* and the *Tif’eret*. *Tif’eret* is the offspring of *Hokhmah* and *Binah*.⁴⁷² The *Hokhmah* and *Binah* are two of the three *sefirot* of the divine head of the mystical body of the *Ein Sof* (*Kether* is the third *sefirah*). *Tif’eret* is not only a god himself, but he also represents the heart and torso

of the body of the Kabbalah god, *Ein Sof*.

The “tree of life” diagram⁴⁷³ depicts the 10 *sefirot* as they are presented in the *Sefer Yetzirah* (Book of Formation) and gives a visual representation of the relationship between the different *sefirot* within the Ein Sof. Note that *Malkuth* and *Shekinah* are the same *sefirah*. In the diagram, only *Malkuth* is depicted. Note also that the spelling varies somewhat from source to source. For example, *Chokmah* in the diagram is the same as *Hokmah* and *Jesod* is the same as *Yesod*. Jewish scholars readily acknowledge that there are many parallels between the Cabalistic concept of god and that found in Buddhism, Hinduism, and so-called Gnosticism.⁴⁷⁴ That is not surprising, since they all flow from the same mystical waters of Babylon. In the Kabbalah, gravity is equated with *Tiphareth* [a/k/a *Tifereth*], the sixth sphere of the Kabbalistic Tree of Life. Sir Isaac Newton simply took that heathen religious belief, cloaked it in mathematical equations, and presented it to the world as “science.”

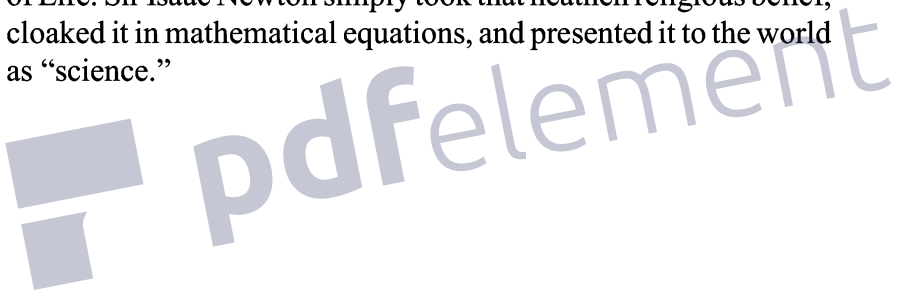

24

Scientific Proof the Earth Does Not Move

Many attempts were made to prove that heliocentricity was true and geocentricity was false. Every such attempt has been a failure. The most famous, because of its precision and irrefutability, was the experiment done by physicist Albert A. Michelson (1852 – 1931) and chemist E. W. Morley (1838 – 1923). The Michelson/Morley experiment, using an interferometer, which measured light rays, established that the earth is stationary.⁴⁷⁵ Michelson was involved in other experiments that confirmed, to his dismay, that the earth is stationary.

The Michelson/Morley experiment (1887) does not stand alone. It is joined in its confirmation of a stationary earth by the James Bradley experiment (1729) (proving that the ether is not carried along by the earth), the Sagnac experiment (1913) (proving that there was in fact an ether), the Michelson/Gale experiment (1925) (proving that the ether passed over the earth once every 24 hours), and Airy's failure (1871) (proving that the stars moved, carried by the ether, while the earth remained stationary).

There are many other experiments that have each time given results that were not only consistent with a stationary earth but indicative of a stationary earth, from the light polarization

experiments of E. Muscart in 1872 to the mutual inductance experiments of Theodore de Coudres in 1889 to the 1903 *Touton-Noble* experiments.⁴⁷⁶ Indeed, there is not a single experiment that proves that the earth moves. The moving earth is based entirely on a theory and is contradicted by all of the experimental evidence.

The Sagnac experiment, proving the existence of ether, destroys the theory of relativity, which necessarily assumes that there is no ether. The Michelson/Gale experiment proved that the ether passed over the earth once every 24 hours, but it did not prove whether it was the ether moving or the earth spinning. Airy's failure determined with scientific certainty that in fact it was the ether carrying the stars that was moving over the earth and that the earth was stationary. Dr. Neville Thomas Jones, Ph.D. explains that "George Airy proved that the world was stationary and the stars are moving."⁴⁷⁷ Because his experiment proved that the earth does not move, which was the opposite of the expected outcome, Airy's experiment is commonly known as "Airy's failure."

There has been a virtual blackout, however, within science education of these experiments. Dr. Malcom Bowden reveals that he "asked 3 Christian physicists if they had ever heard of them; not one had!"⁴⁷⁸ Indeed, in March 2005, another physicist wrote to Dr. Bowden that "after 35 years as a professional physicist, with a thesis in relativity, I only learned of Sagnac's experiment last year."⁴⁷⁹ The degree of the cover-up of true science is simply astounding!

The Michelson/Morley experiment was simple in concept. A light beam was split. One of the split beams was sent at a right angle to earth's supposed direction of travel and the other was sent along the path of the earth's supposed direction of travel. The light traveling in the direction of the earth's travel should have taken longer than the light traveling at right angles to the earth's direction of travel. To the amazement of the scientific world, the

results were null, meaning that there was no difference in the speed of the light beams. That meant that the earth was motionless.

The Michelson/Morley experiment shook the scientific world. The results of the experiment could not be attacked, as the experiment was meticulously conducted, using precise instruments, and it was performed by Albert A. Michelson, whom *The New York Times* described as America's greatest physicist.⁴⁸⁰ The implications were devastating for the Copernican model of a globular spinning earth orbiting around the sun. If the heliocentric model fell, then evolution would not be far behind. The priests of science knew that something had to be done if they were going to maintain their godless religion.

In desperation, the priests of science tried to explain away the null result of the Michelson/Morley experiment. Hendrik A. Lorentz and George Fitzgerald swallowed their pride and put their formerly good names to a ridiculous theory that the null result in the Michelson/Morley experiment was because the solid steel arm that was pointed in the direction of the supposed motion of the earth became shorter due to the earth's movement through the ether. That shortening of the steel caused the light to arrive at the same time, not because the earth was stationary, but because the earth was moving. Seriously, I am not making this up! This supposed contraction became known as the Lorentz/Fitzgerald contraction.

There was absolutely no evidence to support the theory of the Lorentz/Fitzgerald contraction, but it was all they had to try to keep the spinning, and orbiting earth model of heliocentricity alive. They only came up with the theory of the Lorentz/Fitzgerald contraction, because they had nothing else to explain the null result and they were not going to abandon the Copernican model.

Some scientists aver that it is a misnomer to call the

Lorentz/Fitzgerald theory a “contraction,” since as first theorized, it was supposedly the transverse arm of the Michelson/Morley interferometer that was lengthened and so it should actually be called the Lorentz/Fitzgerald expansion.⁴⁸¹ Regardless, if it was called an expansion or contraction, it was an inane theory that was unsupported by any proof. Arthur Miller described the Lorentz/Fitzgerald contraction as “physics of desperation.”⁴⁸² Indeed, it was more akin to a fairy tale for adults, than it was science. It was not long before Einstein was pressed into service, with his theory of relativity.

Notice that the scientific community rejected acceptance of a stationary earth, not because there was any scientific evidence that contradicted it, but because it had become the central “faith” of the godless scientific community. The Copernican theory was simply not to be abandoned, no matter what the scientific evidence showed.

 pdfelement

25

Einstein to the Rescue

Something had to be done about the results of the Michelson/Morley experiment. The high priests of science simply could not allow the world to discover that the earth does not move. Enter Albert Einstein and his theory of relativity. Einstein announced his special theory of relativity in 1905 and his general theory of relativity in 1915.

Einstein's theory of relativity was able to explain away the null results of the Michelson/Morley experiment. According to Einstein the speed of light is constant and consequently an object moving through space would not show movement, if light was used to measure the speed of the motion. According to Einstein, the speed of light is constant for every observer no matter what speed the observer is traveling. Armed with the theory of relativity, scientists argued that the earth was moving, despite the null result of the Michelson/Morley experiment. They alleged that it was incorrectly shown not to be moving in the Michelson/Morley experiment, because the light used in the experiment, which was expected to show the speed of the earth through the ether, could neither increase nor decrease in speed.

The Michelson/Morley experiment was designed to measure the expected speed of the supposedly moving earth

through the ether. Einstein could not have a constant speed of light as he theorized, if there was an ether. Einstein solved that issue by simply announcing that there was no ether. Einstein, by theorizing that there is a constant speed of light and there is no ether, solved the Michelson/Morley null movement result and saved the heliocentric model of an orbiting, rotating earth.

Light travels in waves, which is a fact that Einstein accepted. A wave needs a medium through which to travel. Imagine a wave in water without the water. It is an impossibility. The medium through which light travels is called ether. This simple law of physics that a wave needs a medium through which to travel is something that is easy to understand. The corollary of an ether for light to travel through, however, will seem foreign to the reader, because it is not taught in schools. The educational system has been given over completely to the mystical theory of relativity, where the ether is simply not allowed to exist.

Einstein removed the ether from existence by edict. The problem is that a wave of light cannot exist without a medium for that light. Professor Herbert Dingle explains the absurdity of light waves without an ether through which to travel.

Light consisted of vibrations in that ether, that had physical properties, which also were, in principle, determinable. What Einstein was proposing, therefore, was to retain the finite velocity of light without the existence of any standard with respect to which that velocity had a meaning. Light consisted of waves, with a definite length, frequency and velocity, in nothing; it was the grin without the Cheshire cat. ... The physical part of the theory was expendable; only the equations needed to be saved. Einstein saw a way of saving the equations, and did not consider it worth while to

'explain' light. ... Einstein was satisfied to 'explain' it in terms of things that we understood nothing of — in other words, not to explain it at all. If his assumptions were granted he did save the equations, and when his theory ultimately made its general impact on the world, mathematics had so dominated physics that the non-existence of the Cheshire cat was regarded as a triviality; the grin remained, and all was well.⁴⁸³

Einstein's construct of "no ether" is an impossibility, just as a wave in water without the water is an impossibility. In any event, Einstein was proven wrong, and the ether was proven to exist in the 1913 Sagnac experiment. That experiment proved scientifically, beyond any doubt, that there is in fact an ether, through which light travels.

Indeed, airlines today use cockpit ring laser gyroscopic compasses that are based upon the discovery by George Sagnac of fringe changes in light traveling through the ether. The changes in the fringes of light is then computed into a reading, which tells the pilot about changes in bearing of the airplane. Without ether, those sophisticated optical compasses would not work at all. The very existence of the laser gyroscopic compasses used by airplanes today proves that there is an ether and impeaches Einstein's claim that there is no ether. The existence of ether destroys the theory of relativity and establishes the Michelson/Morley experiment as proving that the earth is stationary.

Einstein removed the ether, which upended the traditional laws of physics. Einstein did not present any proof that there was no ether; he just made it up. Removing the ether was a way of explaining why Michelson/Morley's interferometer showed no motion of the earth. Removing the ether removed the resistance of ether to light waves, which allowed Einstein to conjure the myth that light will not change speed on a moving surface. That

explained away the Michelson/Morley results showing that the earth did not move. If, however, there is an ether, that necessarily means that the earth is stationary, as proven in the Michelson/Morley experiment.

The theory of relativity is a complete lie. It is based entirely on convoluted and deceptive mathematical models. Nikola Tesla's statement about the modern methods of scientists like Einstein is revealing. "Today's scientists have substituted mathematics for experiments, and they wander off through equation after equation, and eventually build a structure which has no relation to reality."⁴⁸⁴

Nikola Tesla was the most brilliant scientist and inventor of his time. So advanced were his discoveries that upon his death in 1943 his research papers were seized by the FBI and classified "Top Secret" at the request of the U.S. War Department. One of Tesla's most notable discoveries was alternating electrical current (a/k/a AC) that is today used to power most homes and businesses. Tesla understood true science and knew a scientific scam when he saw one. In 1935, Tesla called Einstein's theory of relativity "[a] magnificent mathematical garb which fascinates, dazzles and makes people blind to the underlying errors. The theory is like a beggar clothed in purple whom ignorant people take for a king..., its exponents are brilliant men but they are metaphysicists rather than scientists."⁴⁸⁵

Professor Herbert Dingle was once an eminent proponent of the theory of relativity. He later realized that it was simply a myth, supported not by scientific experiments, but rather by false math formulae. He discovered that the theory of relativity is held to be true, not because it is true, but because mathematical formulae were devised and held up as evidence of its truth. "Not only are hypotheses held to contain the 'real truth'; it is now claimed that any (mathematical) hypothesis is necessarily true." (parenthetical in original)⁴⁸⁶

The problem with basing proof for a scientific theory solely on mathematics is that a mathematical equation may not correspond to reality. A mathematical formula may only prove something that is imaginary and not real. Professor Dingle explains:

[T]he symbols that compose a mathematical expression may, with equal mathematical correctness, correspond both to that which is observable and that which is purely imaginary or even unimaginable. If, therefore, we start with a mathematical expression, and infer that there must be something in nature corresponding to it, we do in principle just what the pre-scientific philosophers did when they assumed that nature must obey their axioms, but its immensely greater power for both good and evil makes the consequences of its misapplication immensely more serious.⁴⁸⁷

The experiments supporting the theory of relativity were “thought experiments” performed completely through complicated math formulae designed to bedazzle ignorant laymen. Professor Dingle stated:

[M]athematics has been transformed from the servant of experience into its master, and instead of enabling the full implications and potentialities of the facts of experience to be realised and amplified, it has been held necessarily to symbolise truths which are in fact sheer impossibilities but are presented to the layman as discoveries.⁴⁸⁸

Dr. Dingle reveals the key point that is the cornerstone of the theory of relativity. Many highfalutin scientists do not seem to

know this one simple fact. **“[I]n the language of mathematics we can tell lies as well as truths, and within the scope of mathematics itself there is no possible way of telling one from the other.”**⁴⁸⁹ That is the dirty secret behind the theory of relativity. Einstein used mathematics to tell lies. The only way to determine if a mathematical formula has any validity is to test it in the real world. Dr. Dingle explains that “[w]e can distinguish them only by experience or by reasoning outside the mathematics, applied to the possible relation between the mathematical solution and its supposed physical correlate.”⁴⁹⁰ Physical experiments are not something that have been done with much success in proving the theory of relativity. Consequently, scientists resort to thought experiments, using mathematical formulae, which have no correlation to reality.

How can math be used to tell lies, as alleged by Professor Dingle? A simple example will illustrate how math can be used to support a falsehood. If one were to say that a glass that is half-empty is the same as a glass that is half-full, that would be true. One can use mathematics, however, to make that simple truth be the foundation for a falsehood. Let's put the half-full glass equaling a half-empty glass into an equation, where “E” represents an empty glass and “F” represents a full glass: $\frac{1}{2}E = \frac{1}{2}F$. That equation ($\frac{1}{2}E = \frac{1}{2}F$) is accurate as it is presented; a half empty glass is equal to an half full glass. Now, in basic algebra, if one multiplies both sides by the same number, it does not affect the accuracy of the equation. Thus, to multiply both sides of the equation by two, one would get the result of $E = F$. Under the rules of algebra, that is supposed to be a true statement. We know, however, that in reality an empty glass does not equal a full glass (thus, in reality $E \neq F$). However, mathematics can be used to present a falsehood as truth ($E = F$). That is the type of unreal reasoning that permeates the theory of relativity, where the scientific testing is done in thought experiments, using mathematics. This creates a fantasy world of relativity. The theory of relativity is not science, it is mysticism, supported only by

mathematical models.

Physicists gave up trying to understand the absurd results of the formulae used to explain the theory of relativity, and simply capitulated without much of a fight. They accepted the mathematical formulae of Einstein, even though they often gave inaccurate and incongruous solutions. Dingle explains that “with the apparent success in 1919 of Einstein's general theory with its then quite new and terrifying mathematical machinery of tensor calculus, came the fatal climax. ... [Physicists] gave up trying to understand the whole business, surrendered the use of their intelligence, and accepted passively whatever apparent absurdities the mathematicians put before them.”⁴⁹¹

Einstein's biographer, Ronald Clark, reports that Einstein's friend, Janos Plesch, suggested to Einstein that there seemed to be some connection between mathematics and fiction, Einstein replied: “There may be something in what you say. When I examine myself and my methods of thought I come to the conclusion that the gift of fantasy has meant more to me than my talent for absorbing positive knowledge.”⁴⁹² The theory of Relativity is not science; it is fantasy, conjured by mathematical formulae in the minds of Einstein and his followers.

The blind faith of the scientific community in the supposed truth of the theory of relativity, and its intolerance for any evidence of its invalidity, is akin to adherents in a religious cult. When one realizes that relativity is more a religion than it is science, it explains why the ascension of relativity is in direct proportion to the descent of Christianity in society. It seems that there is more tolerance in religion than there is in the scientific community toward heterodoxy, especially when it comes to the theory of relativity. Indeed, Professor Dingle said as much:

It is ironical that, in the very field in which
Science has claimed superiority to Theology, for

example — in the abandoning of dogma and the granting of absolute freedom to criticism — the positions are now reversed. Science will not tolerate criticism of special relativity, while Theology talks freely about the death of God, religionless Christianity, and so on (on which I make no comment whatever). Unless scientists can be awakened to the situation into which they have lapsed, the future of science and civilisation is black indeed.⁴⁹³ (parenthetical comment in original)

Charles Lane Poor, Professor of Celestial Mechanics at Columbia University, and the author of a number of standard textbooks on astronomy, stated that “the Relativity Theory strikes directly at our fundamental concepts as to the structure of the universe; its conclusions are startling and completely upsetting to our common-sense way of looking at physical and astronomical phenomena.”⁴⁹⁴ Dr. Louis Essen, a distinguished mathematician, and Fellow of the Royal Society, stated that the theory of relativity was not truly a physical theory but rather simply a number of sometimes contradictory assumptions. Lord Ernest Rutherford is considered the father of nuclear physics; so eminent was he that chemical element 104 was named rutherfordium after him. Lord Rutherford has called the theory of relativity, simply “nonsense.”

In 1922, Professor Herbert Dingle wrote *Relativity for All*, one of the first standard textbooks on the theory of relativity. His second book on the subject, written approximately 20 years later, *The Special Theory of Relativity*, remained for a long time the standard work in English and American universities on the theory of relativity. Indeed, Professor Dingle was one of the foremost experts on the theory of relativity in the world. During a span of fifty years, he studied the theory intensively and conferred about it with all the physicists who were experts in it (e.g., Einstein, Eddington, Tolman, Whittaker, Schroedinger, Born and

Bridgman). So renowned was Dingle's expertise on the theory of relativity, that when Einstein died in 1955, the BBC chose Professor Dingle to broadcast a tribute to Einstein.

In 1959, after years of believing and promoting the theory of relativity, Dingle realized that something was wrong. He found a paradox in the theory of relativity. He spent 13 years canvassing his large network of scientists to try to find an answer to the paradox. Nobody could answer the paradox. He tried to publish the paradox, but was refused all access to scientific journals. Finally, in 1972, Dingle decided to publish his conclusion in a book titled: *Science at the Crossroads*. He explained in his book that he only published it because he was denied access to scientific journals to present his evidence. In that book, Professor Dingle presents unimpeachable proof that the theory of relativity is invalid.

In order to understand the paradox with which Professor Dingle was faced, some explanation should be given. The *coup de grace* to the Michelson/Morley experiment results showing that the earth does not move is the central maxim of relativity theory that there is no way to tell which of two bodies is in motion. The theory of relativity provides that motion is relative to the observer. Thus from earth it would appear that the sun is moving. However, from the perspective of the sun, the earth is moving. According to the theory of relativity there is no way to establish which is the case, because the movement of the two bodies is only movement relative to the other body. This maxim of relativity effectively kills the null result of the Michelson/Morley experiment, since according to the theory of relativity, the null result was only a matter of relative perspective. Under the theory of relativity, if you were to fall on your face, it cannot be said that you fell to the ground, as it is equally likely that the earth rose up to meet your face. That is the kind of silly conclusion brought about by the theory of relativity.

In addition to the above relativity of motion, Einstein theorized that time slows down, the faster one travels. For example, if a twin (Paul) takes a trip on a spaceship at near the speed of light and he returns to earth ten years later, his twin brother (Peter), left back on earth, will have aged ten years, but the twin on the spaceship would only have aged very little. The problem with that postulation from Einstein is that under the theory of relativity, the movement of each brother is relative. Each twin sees the other as moving, and therefore each brother should have aged more slowly than the other brother. The conclusion under the theory of relativity is that Peter has aged more slowly than Paul and at the same time Paul has aged more slowly than Peter. Of course, it is impossible for each twin to age more slowly than the other twin.

The twin paradox is chosen by this author, because it very simply illustrates the issue. Professor Dingle, however, never actually used the twin paradox, because there is an alleged quirk in that example that gives the supporters of the theory of relativity an out (or so they allege); they assert that there is no symmetry, since the twin on the spaceship is traveling outbound and inbound, which involves two inertial frames. Of course, that is pure sophistry, and addressing such nonsense is beyond the scope of this book. Professor Dingle was too well versed in the theory of relativity to allow the promoters of relativity such an easy out, so he steered clear of using the aging twins example. He, instead, used an example of two clocks moving in the same trajectory at different speeds.

Professor Dingle asked scientists all over the world to assist him in finding an answer to the paradox using speeding clocks, with one clock traveling faster than the other, in the same direction. Every scientific journal in the world refused to even address the paradox that Dingle raised. No one could resolve the paradox, and the scientific community seemed to think it was impolite to even discuss it. "I can present the matter most briefly

by saying that a proof that Einstein's special theory of relativity is false has been advanced; and ignored, evaded, suppressed and, indeed, treated in every possible way except that of answering it, by the whole scientific world."⁴⁹⁵ In science, a paradox is a self-contradictory conclusion that is logically impossible. A theory that causes a logically impossible result is necessarily wrong. A paradox in the theory of relativity simply had to be suppressed by the high priests of science.

Professor Dingle laid out the paradox, which has never been resolved to this day, as follows:

According to the theory, if you have two exactly similar clocks, A and B, and one is moving with respect to the other, they must work at different rates ..., i.e. one works more slowly than the other. But the theory also requires that you cannot distinguish which clock is the 'moving' one; it is equally true to say that A rests while B moves and that B rests while A moves. The question therefore arises: how does one determine, consistently with the theory, which clock works the more slowly? Unless this question is answerable, the theory unavoidably requires that A works more slowly than B and B more slowly than A --which it requires no super-intelligence to see is impossible. Now, clearly, a theory that requires an impossibility cannot be true, and scientific integrity requires, therefore, either that the question just posed shall be answered, or else that the theory shall be acknowledged to be false. But, as I have said, more than 13 years of continuous effort have failed to produce either response.⁴⁹⁶

Professor Dingle concludes that “[t]he magical influence

of this word [relativity] has transformed science in this field into a superstition as powerful as any to be found in primitive tribes."⁴⁹⁷ We have it on the authority of Professor Dingle, one of the foremost experts on the theory of relativity that the theory of relativity is false.

The theory of relativity is more than just false; it is nonsense. It is based upon the premise that motion is not absolute, but rather it is relative to the frame of reference of the observer. Einstein's motive in constructing such a theory was to explain away the Michelson/Morley null result for the motion of the earth.

According to the theory of relativity, there is no way to tell the difference between an object that is at rest and an object that is moving at a constant velocity in an inertial reference frame. According to Einstein, all motion is relative to the frame of reference of the observer. For instance, according to the theory of relativity, it is equally valid to say that the railroad track is moving under a train as it is to say that same train is traveling at a constant speed over a stationary track. A person standing next to the track would perceive the train moving as it passed by him. But a passenger on the same train moving at a constant speed, who is inculcated in the school of relativity, would perceive the person standing next to the track and the landscape speeding by the train and conclude that it is equally possible that the train is standing still and the earth is moving beneath him as it is that the train is moving on the track. We know, however, that is nonsense. The train is in fact moving. The motion of the train can be detected and measured. The theory of relativity is not based upon true science and measurable observation; it is based upon religious superstition that is propped up by deceptive mathematical models that contradict reality.

The World Heritage Encyclopedia describes the importance of Einstein's theory of relativity in explaining away the null result of the Michelson/Morley experiment.

This [Einstein's 1905 theory of special relativity] allows a more elegant and intuitive explanation of the Michelson-Morley null result. In a comoving frame the null result is self-evident, since the apparatus can be considered as at rest in accordance with the relativity principle, thus the beam travel times are the same. ... Special relativity is generally considered the solution to all negative aether drift (or isotropy of the speed of light) measurements, including the Michelson–Morley null result.⁴⁹⁸

Very simply, the theory of relativity explains that the null result of the Michelson/Morley experiment was because the instrument doing the measuring was, relatively speaking, at rest, as that was its frame of reference, and not because it was actually at rest. Einstein asks us to ignore the reality as actually measured and accept in its place the mathematical postulates of relativity. The theory of relativity postulates that no motion of the earth was detected in the Michelson/Morley experiment not because the earth is in fact motionless but rather because the measurement was performed from the earth. According to Einstein's theory, if the Michelson/Morley experiment would have been done from say the moon, then the moon would have been detected to be motionless and the earth would have appeared to be in motion. Under the superstitious religion of relativity, motion is all relative to the frame of reference of the observer.

Lest you think I am overstating the fact, please make your own judgement after reading the explanation of the theory of relativity by Albert Einstein himself during an address he gave at Princeton University:

What we mean by relative motion in a general sense is perfectly plain to everyone. If we think of a wagon moving along a street we know that it is

possible to speak of the wagon at rest, and the street in motion, just as well as it is to speak of the wagon in motion and the street at rest. That, however, is a very special part of the ideas involved in the principle of Relativity.⁴⁹⁹

The sad thing is that scientists believed him! And they still believe him today! They do not perceive that relativity is not true science, it is a religious deception clothed in scientific lingo. It is based on belief in mystical principles, which contradict common observation. Gerrard Hickson accurately describes Einstein's theory of relativity as the very negation of reason. Referring to the above quote from Einstein, Hickson states:

That would be amusing if we read it in a comic paper, or if Mutt and Jeff had said it; but when Professor Einstein says it in a lecture at the Princeton University, we are expected not to laugh; that is the only difference. It is silly, but I may not dismiss the matter with that remark, and so I will answer quite seriously that it is only possible for me to speak of the street moving while the wagon remains still— and to believe it— when I cast away all the experience of a lifetime and am no longer able to understand the evidence of my senses; which is insanity. Such self-deception as this is not reasoning; it is the negation of reason; which is the faculty of forming correct conclusions from things observed, judged by the light of experience. It is unworthy of our intelligence and a waste of our greatest gift; but that introduction serves very well to illustrate the kind of illusion that lies at the root of Relativity.⁵⁰⁰

Nevile Martin Gwynne describes the irrationality that is

woven through the warp and woof of the theory of relativity.

The concept of relativity attached to his [Einstein's] name and propagated by him represents an attack on human reason so insidious and diabolical, and so successful, that no opportunity of demonstrating its falsity, and not only its falsity but, to anyone prepared to believe his own powers of reason, its blatantly obvious falsity, should be allowed to pass.⁵⁰¹

Gwynne proves that most of the elements of the theory of relativity were not the discoveries (Gwynne properly describes them as inventions) of Einstein. Indeed, if one examines the historical record, the only reasonable conclusion is that Einstein plagiarized the entire theory of relativity. Gwynne states that "Einstein's works can be searched from beginning to end without revealing a single original thought of real importance."⁵⁰² Gwynne documents the little known historical facts that Einstein stole ideas from other scientists and passed them off as his own. He plagiarized their work. He gave no attribution to the other scientists.

Curved space, for instance, was thought of by Riemann; adding a fourth dimension, that of time, to geometry to create the new concept of space-time, by Minkowski; the doctrine that objects contract in proportion to the speed at which they moved, by Fitzgerald; and the idea that the velocity of light in a vacuum was constant irrespective of the notion of any object connected with the light ray, by Lorentz. ... Did he [Einstein] first assert the impossibility of detecting the velocity of the earth through the ether? No, this was done by J.H. Poincaré and H.A. Lorentz. ... Did Einstein coin the name

Relativity? No, Poincaré did. ... It was Poincaré too, who first asserted that no velocity can exceed that of light. Einstein was not the first to assert that a clock in motion runs slow. This was done by Sir Joseph Larmor. Einstein was not the first to assert that matter is crinkles in curved space. Professor W.K. Clifford advanced this quaint notion in 1870, nine years before Einstein's birth. ... Did Einstein even invent the famous equation, $E=mc^2$, which has become almost synonymous with his name the equation from which nuclear energy and nuclear destruction capability are supposedly derived? Not even that. In 1881 J.J. Thompson had produced a formula, $E=\frac{3}{4}mc^2$, in respect of a charged spherical conductor moving in a straight line. In 1900 Poincaré suggested that electromagnetic energy might possess mass density in relation to energy density, such that $E=mc^2$, where E is energy and m is mass.⁵⁰³

Plagiarization is intellectual theft. The unimpeachable record proves that Einstein was not a genius, but was simply a very clever con man, with powerful backers. Gwynne concludes that “[t]he truth about Einstein is that he was no more than a puppet.”⁵⁰⁴ Gwynne presents compelling evidence that Einstein was selected to play the specific role of refuting the Michelson/Morley experiment and reestablishing the rotating globular earth.

[I]f Einstein had not existed another would have been selected to fill his place, for he possessed no qualities which are not available in profusion in almost any place in any age. ... The obstinate truth about Einstein is that in mathematics he was no more than competent and that among the so-called discoveries presented to the world

under his name one can search in vain for one that was original. Had Einstein not been selected, for reasons which had nothing to do with intellectual ability, to act out a role which was deemed necessary for the furtherance of the war against God and civilisation, his claim to immortal fame would have been that of a talented and not-undistinguished physicist, a life-long Zionist, an occasionally enthusiastic admirer of Stalin's Russia.⁵⁰⁵

Einstein was a front-man for very powerful interests behind the theory of relativity. That theory was simply an amalgamation of theories propounded by many scientists over many years. As Gwynne points out the global elite needed to have a single front-man for their theory to be popularly accepted.

[I]t is much easier to impose false beliefs on the world if they are personalised. If a theory is put forward without reference to the person who originated it, there will be a tendency for it to be judged on its merits and then, if it clearly has no merits, for it to be rejected. This is far from being the case if a theory, however ludicrously opposed to common sense, is put forward by a man of universally acknowledged genius. When that happens, the tendency will be for the theory to be examined with respect; if it cannot be understood, this will be ascribed to the incapacity of the person examining the theory; if it appears manifestly illogical, it will be assumed that the originator has grasped a logic which is beyond the reach of lesser mortals. In short, it will gradually become accepted on no better grounds than the authority of the person who has advanced it.⁵⁰⁶

Why was Einstein, of all people, chosen to be the front man? There are very powerful inter-generational interests behind promoting Einstein. These interests have an occult religious agenda to enslave the world. Martin Gwynne identifies the core of the conspiracy as Jewish. That Einstein was a Zionist Jew was probably the qualifying factor that put him at the top of the list to be the mouthpiece for the Satanic conspiracy to send the scientific world into darkness through the theory of relativity.

From the middle of the nineteenth century onwards, those presented to the world as the modern geniuses marking the turning points in civilisation have been Jews. I do not wish to exaggerate this, and it is certainly true that non-Jews too, such as Darwin at the beginning of the period and Lord Keynes in more recent times, have had their nonsense presented as majestic contributions to human knowledge. Nevertheless, if asked to name the three men whose writings had the greatest influence in shaping the modern world, few would go beyond Karl Marx, Sigmund Freud and Albert Einstein. Explanations for the phenomenon, adequate or otherwise, are suggested elsewhere in other papers that I have written. Here I record only the fact and the inference that can be derived from it. The Jews are entering into what they believe to be their inheritance.

If it be accepted that it was desirable to build up the reputation of a single man for the difficult task of imposing Relativity on the world and that that man should be a Jew, why was Einstein, out of all the other Jewish scientists available, chosen to play the role assigned to him? One can only speculate. Clearly his being a Zionist and a

Communist would have recommended him highly to those who selected him; it seems to be agreed by all who came into contact with him that he had much charm, probably indispensable in the task allotted to him; and eyewitness accounts of his lectures provide evidence of considerable abilities as an actor and a showman, which, for the successful accomplishment of the purpose for which he was used, are talents even more necessary than charm. There must, however, have been many other people with similar or better credentials even in a population restricted to people interested in physics. Failing some revelation by those who chose him, all that can be said is that we need have little doubt that he earned his duties and his privilege somehow. I have given some indication of what Isaac Newton did to earn the rewards that he received and is still receiving in this world. Those who recall this and take seriously verses eight and nine of the fourth chapter of St. Matthew have little alternative to the belief that such fame and adulation as Einstein received in his lifetime and has received since, and which on the face of it were wholly undeserved, must have been earned at the expense of an extremely exacting bargain in respect of his immortal soul.⁵⁰⁷

After the general acceptance of Einstein's theory of relativity, science entered into a strange new world where experiments were not done using instruments in the physical world, but instead using mathematics in the mind of the scientists. Einstein was famous for announcing new "mind experiments."

Einstein claimed that he did not know of the Michelson/Morley experiment prior to coming up with his special

theory of relativity in 1905. Robert Shankland published an article in 1963, in which he stated that Einstein told him in 1950 that he only became aware of the Michelson/Morley experiment after he published his paper on special relativity in 1905. Shankland pointed out that indeed Einstein did not mention the Michelson/Morley experiment in his 1905 paper, suggesting by that fact that Einstein did not know about the Michelson/Morley experiment.

Einstein's claimed ignorance of the Michelson/Morley experiment is contradicted by other statements that he made indicating that in fact he did know about the experiment. Einstein is on record admitting that he did in fact know about the Michelson/Morley experiment and it played a role in his theory of relativity.⁵⁰⁸ Einstein's biographer, Ronald Clark, stated that one of the principle issues for science with the Michelson/Morley experiment was that the experimental results proved that the earth is stationary. Clark explained the implications of the Michelson/Morley experiment meant that the whole Copernican theory had to be scuttled, which was "unthinkable" for the scientific community.⁵⁰⁹

Einstein never mentioned the Michelson/Morley experiment in his 1905 paper announcing his theory of special relativity.⁵¹⁰ In 1942 Einstein claimed to Michelson's biographer that he had already become "pretty much convinced of the validity of the [relativity] principle before I did know this [Michelson/Morley] experiment and its results."⁵¹¹ It seems that Einstein was trying to avoid having anyone connect his theory of relativity with the Michelson/Morley experiment. However, the historical evidence suggests that Einstein was lying. Think about it; how could anyone believe that Einstein would be ignorant of the Michelson/Morley experiment, when in fact it was the talk of the entire scientific community? His claim of ignorance simply does not pass the smell test. Regardless, we have proof that Einstein lied when he claimed ignorance of the Michelson/Morley

experiment.

Forty-two letters were uncovered between Einstein and his fiancée Mileva Mari. Those letters reveal that in fact Einstein knew about the Michelson/Morley experiment as early as 1899.⁵¹² In addition, in a recently uncovered 14 December 1922 speech that Einstein delivered at Kyoto University in Japan, Einstein admitted that he was aware of the Michelson/Morley experiment and the “strange result” of that experiment affected directly his theory of special relativity.

While I was thinking of this problem in my student years, I came to know the strange result of Michelson's experiment. Soon I came to the conclusion that our idea about the motion of the earth with respect to the ether is incorrect, if we admit Michelson's null result as a fact. This was the first path which led me to the special theory of relativity. Since then I have come to believe that the motion of the Earth cannot be detected by any optical experiment, though the Earth is revolving around the Sun.⁵¹³

Notice Einstein reinforces the scientific myth that the earth revolves around the sun, but he claims that fantastic movement “cannot be detected by any optical experiment.” Why can the movement of the earth not be detected by any optical instrument? Because there are no optical instruments that can detect movement that is not there. Indeed, Einstein knows that, which is why he is so certain that no instrument could ever detect the motion of the earth.

The translation of Einstein's has been criticized by two Japanese academicians. It seems that it is important to many in the scientific field to cast some doubt on whether Einstein knew about the Michelson/Morley experiment. The Japanese academicians are

trying to undermine the startling fact that Einstein was motivated to come up with his theory of relativity by the Michelson/Morley experiment. The circumstances and the personage behind the translation of Einstein's Kyoto speech testify to its accuracy.

In August 1982 *Physics Today* published the above quoted English translation by Yoshimasa A. Ono of Einstein's speech, which was derived from the original notes taken by the J. Ishiwara. The speech by Einstein was given in German and translated for the Japanese audience simultaneously by J. Ishiwara. The translator, Ishiwara, was a professor of physics at Tohoku University, and was quite familiar with both Einstein and the theory of relativity, because he had studied under Arnold Sommerfeld and Einstein from 1912 to 1914. Chinese intellectual Zheng Zhenwen vouches for Ishiwara's scientific credentials. Zhenwen stated at the time that Ishiwara was "the only expert of relativity studies in Japan," and that Ishiwara "had a unique understanding of the theory of relativity."⁵¹⁴

The *Physics Today* article reveals that "Ishiwara kept careful notes of the lecture, and published his detailed notes (in Japanese) in the monthly Japanese periodical *Kaizo* in 1923; Ishiwara's notes are the only existing notes of Einstein's talk."⁵¹⁵ Of all the people in the world, Ishiwara was most qualified to accurately translate Einstein's original German into Japanese. His only motive was to accurately translate and memorialize what was said by the world renowned physicist, Albert Einstein.

There is confirmation that the Japanese translation of Einstein's Kyoto speech is accurate. That confirmation comes in the form of a speech Einstein gave a year before his Kyoto speech, during which Einstein similarly admitted that he knew about the Michelson/Morley experiment before he came up with his theory of special relativity. In May of 1921, during a visit to the University of Chicago, where Michelson was on the faculty, Einstein gave a short speech at the Francis W. Parker School. In

that speech he stated, in pertinent part:

I thought about whether it would be possible to perceive through some experiment that the earth moves in the ether. But when I was a student, I saw that experiments of this kind had already been made, in particular by your compatriot, Michelson. He proved that one does not notice anything on earth that it moves, but that everything takes place on earth as if the earth is in a state of rest.⁵¹⁶

The above 1921 statement by Einstein impeaches his later claims that he did not know about the Michelson/Morley experiment. Jeroen van Dongen draws the ineluctable conclusion from Einstein's 1921 statement that Einstein knew about the Michelson/Morley experiment long before he came up with his special theory of relativity and that the Michelson/Morley experiments influenced his theory of special relativity.

What does the Parker school lecture imply for our understanding of Einstein's relation to the Michelson-Morley experiment, and its influence on the creation of the special theory? Taking the text at face value, there can be no doubt that Einstein knew of the Michelson-Morley experiment prior to 1905. He attributed a significant role to ether drift experiments in general, and singled out the Michelson-Morley experiment for specific mention. It further suggests that Einstein had learned of the experiment before becoming convinced of the principle of relativity—contrary to his later recollections.⁵¹⁷

Why was Einstein so insistent in later years in claiming he

was ignorant of the Michelson/Morley experiment? Because, he could not allow there to be any connection made between his theory of relativity and the results of the Michelson/Morley experiment. To do so would give up the game. His theory of relativity was trotted out, publicized, and crammed down the throats of academia for the sole purpose of explaining away the Michelson/Morley result that proved the earth does not move. Einstein could not allow the world to know that. Hence, he falsely claimed that he did not even know about the Michelson/Morley experiment when he devised his theory of relativity.

Most people do not know that Einstein was a con artist chosen to play a role. In order for his theory of relativity to maintain its status, however, the powerful elite must also maintain Einstein's esteem as a paragon of intellect. If Einstein is found out to have been a fraud, then his theory of relativity will be scrutinized and found out to be an elaborate scientific deception. Consequently, Einstein has been elevated to the stature of a scientific demigod, and the world's propaganda machine intends to keep him there. For example, Frederic Golden in *Time Magazine* described Einstein as follows: "He was the embodiment of pure intellect, ... he was unfathomably profound — the genius among geniuses who discovered, merely by thinking about it, that the universe was not as it seemed. ... his ideas, like Darwin's, reverberated beyond science, influencing modern culture."⁵¹⁸

What was the occasion for such praise from *Time*? Golden was describing Einstein in the December 31, 1999, *Time Magazine* cover story about him. Einstein had been named *Time Magazine*'s "Person of the Century." Think about that for a moment; Albert Einstein was selected as the most influential person from among all the persons who lived during that 20th century. That should give some idea of the importance to which the powerful elite running the world think it is to keep people ignorant of the fact that the earth does not move. That brings to mind the warning of Jesus: "Woe unto you, when all men shall

...speak well of you! for so did their fathers to the false prophets.
(Luke 6:26)

Apparently, some very powerful interests are very happy about the hoax of Einstein's theory of relativity. These powerful

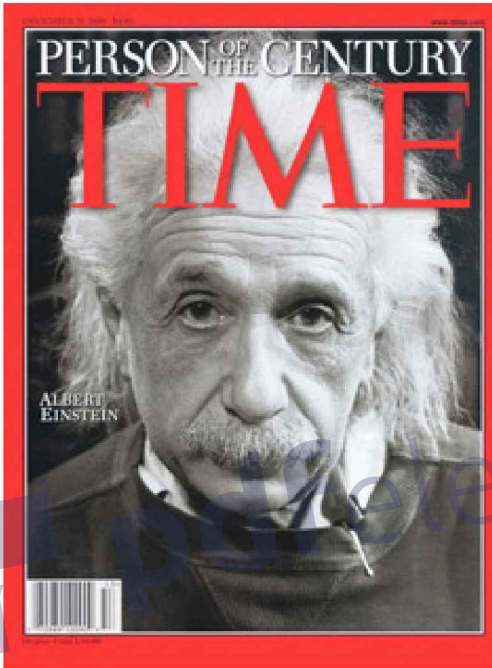

interests are dark and evil. Jewish controlled Time Magazine is owned by one of the largest media conglomerates in the world, Time Warner. The founders of Time Magazine were Briton Hadden and Henry Luce, who were both members of the Satanic secret society, the Brotherhood of Death, commonly known as the Skull and Bones Society.

President George W. Bush, in his autobiography, *A Charge to Keep* stated: **"During my senior year I joined Skull and Bones, a secret society, so secret I can't say anything more."** What is so secret that he cannot speak any further about it? The secret is that in return for power, wealth, and fame, he must blindly obey his satanic masters in their antichrist conspiracy to enslave and rule the world. The initiation ceremony for Skull and Bones involves, but is not limited to, the inductees lying naked in a coffin and telling their deepest sexual secrets. Anton LaVey, the founder of the Church of Satan, in his *Satanic Rituals: Companion to the Satanic Bible*, states that such a coffin ritual is

a satanic ritual common in many pagan orders. During the ritual, a powerful spiritual force charges through the participants transforming their lives dramatically. This powerful spiritual force is a devil. The participants in these ceremonies end up possessed by a devil.

Evidence indicates that the Order of Skull & Bones founded at Yale in 1832 is a chapter of the Illuminati, which was originally founded in 1776 at the University of Ingolstadt in Germany.⁵¹⁹ From this we know that Skull & Bones is not American at all, but is a branch of a foreign secret society.⁵²⁰

As with the Jesuits and the Illuminati, Skull & Bones has many ostensible Gentiles who are members. From this fact most people have mischaracterized the Skull & Bones as a purely Gentile organization. That is not true. Just as with the Illuminati and the Jesuits, the Skull & Bones is controlled by and serves the interests of Zionist Jews. George W. Bush is a prime example of an ostensible Gentile member of Skull & Bones who acted in the interests of Israel to the detriment of the United States. He was completely controlled by Zionist Jews.

The Jewish control of Skull & Bones comes from its roots as a chapter in the crypto-Jewish Illuminati. Some of the practices and terms of the Skull & Bones reveal the Jewish nature of the Order. For example, those outside Skull & Bones are referred to by Skull & Bones members as vandals and **“Gentiles.”**⁵²¹ Furthermore, in an attempt to conceal the meanings of their writings from any Gentile outsider who may obtain a copy, members of the Skull & Bones often obscure key words by deleting the vowels. For example, patriarchs would be written as p-tr-rchs, bones would be written as b-n-s.⁵²² The Hebrew alphabet does not have vowels, they use accent marks, and so Jews are accustomed to writing without using vowels. It is not surprising that they would follow that same practice when trying to conceal the meaning in their writings from the uninitiated

Gentile world.

The Skull & Bones use the Hegelian dialectic to change society into a totalitarian state. Under Hegel's dialectic there must be a conflict, either real or perceived, between a thesis and an antithesis which is resolved by a synthesis of the two. The secret societies create these conflicts in order to move society regressively away from Christ and Christian principles and toward Satan and satanic principles. David Bay explains the origin and power behind the Cabalistic Skull and Bones:

The Brotherhood of Death Society in the United States is the Skull and Bones Society in Yale University in New Haven, Connecticut. Its belief structure is identical to that of the Thule Society. Therefore, we can conclude that Bones Men affirm this belief about Jesus Christ, thus condemning them to committing the Unpardonable Sin. The list of some of the Families comprising Skull and Bones is frightening, for it immediately shows the extent to which America has been influenced by this Satanic organization. Remember, the men of these families have likely committed the Unpardonable Sin. (Quoting from Antony Sutton, "America's Secret Establishment", p. 22).

Rockefeller Family (Standard Oil), Weyerhaeuser Family (Lumber), Sloane Family (Retailing), Pillsbury Family (Flour Milling), J.P. Morgan Family (Banking), Taft Family (Politics), Bush Family, including former President George Bush. Wait a minute, you say, George Bush likely committed the Unpardonable Sin because of his membership in Skull and Bones? Yes. Now, you can see how easy it was for Bush to lead the

charge into the Satanic New World Order. Now you can see that Bush was far different in his innermost heart than he was on his media-created surface.⁵²³

David Bay mentions Skull and Bones member George H.W. Bush spearheading the Satanic New World Order. Indeed, President Bush stated in his state of the union address before a joint session of the U.S. Congress regarding the U.S. led invasion of Iraq that “[w]hat is at stake is more than one small country; it is a big idea: a **new world order**.”⁵²⁴

President Bush was not leading anything, he was simply an effeminate sycophant, who was obedient to his Zionist overlords. A little known fact is that one of the first public mentions of a “new world order” was in reference to the worldwide interests of the Jews. The October 6, 1940 issue of The New York Times reported that “Arthur Greenwood, member without portfolio in the British War Cabinet, assured the Jews of the United States that when victory was achieved an effort would be made to found a **new world order**.”⁵²⁵ The message from Greenwood was delivered by Rabbi Maurice L. Perlzweig, chairman of the British section of the executive committee of the World Jewish Congress, to Dr. Stephen S. Wise, chairman of the executive committee of the World Jewish Congress.⁵²⁶ Greenwood’s message was to the Jews and for the Jews.

NEW WORLD ORDER PLEGGED TO JEWS

Arthur Greenwood of British
War Cabinet Sends Message
of Assurance Here

RIGHTING OF WRONGS SEEN

English Rabbi Delivers to Dr.
S. S. Wise New Statement
on Question After War

In the first public declaration on the Jewish question since the outbreak of the war, Arthur Greenwood, member without portfolio in the British War Cabinet, assured the Jews of the United States that when victory was achieved an effort would be made to found a new world order based on the ideals of "justice and peace."

Mr. Greenwood, who is Deputy Leader of the British Labor party, declared that in the new world the "conscience of civilized humanity would demand that the wrongs suffered by the Jewish people in so many countries should be righted." He added that after the war an opportunity would be given to Jews everywhere to make a "distinctive and constructive contribution" in the rebuilding of the world.

The message was delivered last week to Dr. Stephen S. Wise, chairman of the executive committee of the World Jewish Congress, by Rabbi Maurice L. Perlzweig, chairman of the British section of the congress. Rabbi Perlzweig arrived from England Monday evening.

Intention to Right Wrongs

Comparing the statement with the Balfour Declaration of 1917, Dr. Wise declared that in a sense it had "wider and farther reaching implications," as it dealt with the status of Jews throughout the world. He said that Mr. Greenwood's message could be interpreted as a statement of England's firm

intention to help right the wrongs which Jews have suffered and continue to suffer today because of Hitler's "disorder and lawlessness." Mr. Greenwood, sending the Jews of America a message of "encouragement and warm good wishes," wrote:

"The tragic fate of the Jewish victims of Nazi tyranny has, as you know, filled us with a deep emotion. The speeches of responsible statesmen in Parliament and at the League of Nations during the last seven years have reflected the horror with which the people of this country have viewed the Nazi relapse into barbarism.

"The British Government sought again to secure some amelioration of the lot of persecuted Jewry both in Germany itself and in the countries which were infected by the Nazi doctrine of racial hatred. Today the same sinister power which has trampled on its own defenseless minorities, and by fraud and force has temporarily robbed many small peoples of their independence, has challenged the last stronghold of liberty in Europe.

New World Order Forecast

"When we have achieved victory, as we assuredly shall, the nations will have the opportunity of establishing a new world order based on the ideals of justice and peace. In such a world it is our confident hope that the conscience of civilized humanity would demand that the wrongs suffered by the Jewish people in so many countries should be righted.

"In the rebuilding of civilized society after the war, there should and will be a real opportunity for Jews everywhere to make a distinctive and constructive contribution; and all men of good-will must assuredly hope that in new Europe the Jewish people, in whatever country they may live, will have freedom and full equality before the law with every other citizen."

In an interview at the Hotel Astor, Rabbi Perlzweig declared he was certain Mr. Greenwood "speaks for England." There is a clear realization, he added, that freedom and emancipation for the Jewish people are tied up with emancipation and freedom for people everywhere. The message, Rabbi Perlzweig remarked, was the subject of earnest consideration by the British Government.

"This is a declaration in behalf of the whole world," he observed. "Here the British Government expresses clearly what it hopes will take place after the war is won."

Figure 132: The New York Times, October 6, 1940, page 10.

Greenwood's statement was designed to enlist the powerful Jewish interests in the war with Germany. By making

that promise, England had promised the Jews English assistance in gaining Jewish hegemony over a new world order, if the Jews would use their enormous resources and influence to deliver the United States into the war against Germany. Indeed, that is exactly what happened. The “New World Order” is world domination by the Jews. It is the goal of the Zionist conspiracy.

The Skull and Bones Society is just one of many occult organizations doing the work of the devil. “For we wrestle not against flesh and blood, but against principalities, against powers, against the rulers of the darkness of this world, against spiritual wickedness in high places.” (Ephesians 6:12) That spiritual truth seems to have been missed by Dr. Dingle. He simply could not understand how and why the clearly fallacious theory of relativity could gain such universal acceptance in the scientific community. Dr. Dingle, in frustration, asked:

How is it possible that such an obvious absurdity [as the theory of relativity] should not only have ever been believed but should have been maintained and made the basis of almost the whole of modern physics for more than half a century; and that, even when pointed out, its recognition should have been universally and strenuously resisted, in defiance of all reason and all the traditions and principles of science?⁵²⁷

On November 17, 1952, the Prime Minister of Israel, David Ben Gurion, asked Albert Einstein to accept an invitation to become the President of Israel, upon the authorization of the Knesset of Israel.⁵²⁸ Einstein turned down the offer, but the offer is testimony to the importance and esteem with which Einstein was held among Jews. It also demonstrates the political importance of the theory of relativity to the Jews. The descent in the minds of men of God, who created a flat, immovable earth, gives rise to the ascent of Jews in power and influence in the

world. Having the earth become one of many millions of planets in the universe (and a rather insignificant one at that) drives from the minds of men any thought that God created a unique earth, at the center of his creation, and that man is made in his image. Once God is removed from the thoughts of men, it is then possible to introduce ideas of “everything is relative,” where there is nothing inherently good or bad, because it is all relative to a person’s own ethical opinion. There is no longer reference to absolutes contained in the bible, morals become malleable, with each man a law-maker in his own right. So we see that the theory of relativity is a theory that bleeds into all aspects of society. Indeed, read in Psalms 19:1-8 how there is a direct correlation between knowledge of God’s creation and his commandments. Concealing the glory of God as declared by his handiwork, makes it very easy to introduce concepts of relative morality. All manner of sin can then be justified (e.g., abortion and sodomy).

The heavens declare the glory of God; and the firmament sheweth his handywork. Day unto day uttereth speech, and night unto night sheweth knowledge. There is no speech nor language, where their voice is not heard. Their line is gone out through all the earth, and their words to the end of the world. In them hath he set a tabernacle for the sun, Which is as a bridegroom coming out of his chamber, and rejoiceth as a strong man to run a race. His going forth is from the end of the heaven, and his circuit unto the ends of it: and there is nothing hid from the heat thereof. The law of the LORD is perfect, converting the soul: the testimony of the LORD is sure, making wise the simple. The statutes of the LORD are right, rejoicing the heart: the commandment of the LORD is pure, enlightening the eyes.” (Psalms 19:1-8)

26

Conspiracy

Conspiracy is a concept that has been propagandized into disfavor, much to the delight of Satan and his minions, who are only too happy to push the idea that if one believes there is a world conspiracy against Jesus Christ and his followers he must be a radical on the fringe of society or worse. Most people are afraid of being marginalized and thus avoid speaking of conspiracies. People instead try to construe events as coincidental, when in fact they can only be adequately explained as the product of prior agreements of conspirators who have combined in coordinated actions. God has revealed that there is a religious conspiracy.

There is a conspiracy of her prophets in the midst thereof, like a roaring lion ravening the prey; they have devoured souls; they have taken the treasure and precious things; they have made her many widows in the midst thereof. Her priests have violated my law, and have profaned mine holy things: they have put no difference between the holy and profane, neither have they shewed difference between the unclean and the clean, and have hid their eyes from my sabbaths, and I am profaned among them. Her princes in

the midst thereof are like wolves ravelling the prey, to shed blood, and to destroy souls, to get dishonest gain. And her prophets have daubed them with untempered mortar, seeing vanity, and divining lies unto them, saying, Thus saith the Lord GOD, when the LORD hath not spoken. (Ezekiel 22:25-28)

Notice that it was the Jewish prophets and priests whom God identified as being involved in the conspiracy. They were turning people from God, which caused their damnation in hell. Thus they were “devouring souls” like spiritual ravening lions. The metaphor of a ravening lion, which God has used elsewhere in the bible to describe the devil himself, suggests that the Jewish prophets and priests were acting as the direct agents of Satan: “Be sober, be vigilant; because your adversary the devil, as a roaring lion, walketh about, seeking whom he may devour.” (1 Peter 5:8) The result of the longstanding conspiracy against God is that the conspirators had turned to iniquity and they served other gods.

And the LORD said unto me, A conspiracy is found among the men of Judah, and among the inhabitants of Jerusalem. They are turned back to the iniquities of their forefathers, which refused to hear my words; and they went after other gods to serve them: the house of Israel and the house of Judah have broken my covenant which I made with their fathers. (Jeremiah 11:9-10)

The conspiracy against God has continued through history up to and beyond the first coming of Jesus Christ. We read in the following passage, how the Jews conspired to kill Jesus.

Then assembled together the chief priests, and the scribes, and the elders of the people, unto the

palace of the high priest, who was called Caiaphas, And consulted that they might take Jesus by subtilty, and kill him. (Matthew 26:3-4)

The Jews stirred up the people, who then persuaded the Roman governor, Pontius Pilate, to crucify Jesus. “[T]he chief priests and elders persuaded the multitude that they should ask Barabbas, and destroy Jesus.” (Matthew 27:20) The methods used by the Jews have not changed. Today the Jews control the mass media, which they use to propagandize the people into pushing the politicians into doing their bidding against God and his anointed.

The conspiracy against the LORD and his anointed has been festering since the fall of man in the garden of Eden. It continues to this day and involves the rulers of the earth.

Why do the heathen rage, and the people imagine a vain thing? **The kings of the earth set themselves, and the rulers take counsel together, against the LORD, and against his anointed, saying, Let us break their bands asunder, and cast away their cords from us.**

He that sitteth in the heavens shall laugh: the Lord shall have them in derision. (Psalms 2:1-4)

This monstrous conspiracy, while it involves men, is not headed by a man. “For we wrestle not against flesh and blood, but against principalities, against powers, against the rulers of the darkness of this world, against spiritual wickedness in high places.” (Ephesians 6:12) The kingpin of this diabolical conspiracy is that terrible dragon, Satan. He is the adversary of Almighty God. He is also an adversary to all of God’s creation. Satan tried to tempt Jesus into worshiping him, but Jesus quoted from God’s word and told Satan that one should only worship God.

Again, the devil taketh him up into an exceeding high mountain, and sheweth him all the kingdoms of the world, and the glory of them; And saith unto him, All these things will I give thee, if thou wilt fall down and worship me. Then saith Jesus unto him, Get thee hence, Satan: for it is written, Thou shalt worship the Lord thy God, and him only shalt thou serve. (Matthew 4:8-10)

If you are a disciple of God's perfect and holy Son Jesus Christ, then Satan hates you. "Be sober, be vigilant; because your adversary the devil, as a roaring lion, walketh about, seeking whom he may devour." (1 Peter 5:8) God, however, has a means by which one can avoid becoming the prey of Satan: "Submit yourselves therefore to God. Resist the devil, and he will flee from you." (James 4:7) In order to resist the devil one must first know his plans and methods.

27

Identifying the Conspirators

Zionist Jews have created all manner of antichrist philosophies designed to propagandize and enslave the masses. One of the principal satanic movements propagated by Zionist Jews is communism. Paragraph three of Protocol 2 of the Protocols of the Learned Elders of Zion states: “think carefully of the successes we arranged for Darwinism (Evolution), Marxism (Communism), Nietzsche-ism (Socialism). To us Jews, at any rate, it should be plain to see what a disintegrating importance these directives have had upon the minds of the goyim.”⁵²⁹

Rabbi S. Wise stated in the May 5, 1935, American Bulletin: “Some call it Marxism; I call it Judaism.”⁵³⁰ On April 4, 1918, The Jewish Chronicle stated that “the ideals of Bolshevism are consonant with the finest ideals of Judaism.”⁵³¹

The fact that communism is actually a religious philosophy born of the Talmud and put into practice has been concealed from the ignorant Gentiles. In a 1971 White House recording released by the National Archives in 1999, President Richard Nixon revealed: “The only two non-Jews in the communist conspiracy were Chambers and Hiss. . . . Every other one was a Jew and it raised hell with us.”⁵³² The Talmudic Jews have been successful in preventing any revelations about their

involvement in establishing a new communist world order by labeling anyone who exposes their efforts an antisemite.

Many think that Zionism is the struggle by the Jews for a homeland. Zionism is much more than the Jews establishing a homeland. That is merely a cover for a much grander plan to rule the world. Zionism is the child of the Talmud, and Talmudism is communism. The communist revolution in Russia was planned and executed by Jews according to the doctrines of their Talmud.

Make no mistake about it, the communists stated at the outset that their aim is world domination. The 1919 World Congress of the Communist International stated that it intended to wage a “fight by all available means, including armed force, for the overthrow of the international bourgeoisie and for the creation of an international Soviet republic.”⁵³³ That statement was in essence a declaration of war against all countries in the world. Once one understands that communism is a cloak for Zionism, it becomes clear that the Zionists have declared war on the world and plan on ruling the world with an iron fist after their victory.

Communism is essentially Talmudic Judaism. The exoteric communism portrays itself as an atheistic political movement. The persecution of the Christian churches wherever communists have been brought to power seems to prove that point. However, the real nature of communism as a Judaic religious movement is manifest by the fact that Jewish synagogues do not suffer the same fate as Christian churches in communist countries. Communism reveals Judaism as a satanic conspiracy against God and man.

Jewish scholar Henry Makow, Ph.D., was asked why when the Bolsheviks took over Russia and tried to eliminate religion, Christian churches were destroyed, and the Christian clergy were killed or imprisoned, yet the Jewish synagogues and rabbis remained untouched. If communism was a political

movement that was antagonistic to all religion, why was Judaism given a pass? Makow researched that issue:

Last week I stumbled across the answer in a book by American historian Edwin Schoonmaker:

“Fifteen years after the Bolshevik Revolution was launched to carry out the Marxist program, the editor of the ‘American Hebrew’ could write: ‘According to such information that the writer could secure while in Russia a few weeks ago, not one Jewish synagogue has been torn down, as have hundreds-perhaps thousands of the Greek Catholic Churches. . . . In Moscow and other large cities one can see Christian churches in the process of destruction . . . [whenever] the Government needs the location for a large building.’ (American Hebrew, Nov. 18, 1932, p. 12) Apostate Jews, leading a revolution that was to destroy religion as the ‘opiate of the people’ had somehow spared the synagogues of Russia.” (“Democracy and World Dominion,” 1939, p.211)

If the Communists hated God and religion so much, why didn't they destroy synagogues too? Do Christianity and Judaism worship the same God? Or can a religion that claims an exclusive ownership of God be a religion? Could it be that Judaism is really a secret society like Freemasonry where the members don't know the hidden agenda, which is in fact expressed by Communism? Although many religious Jews were indeed anti-Communist, Schoonmaker's information suggests there may be an affinity between Talmudic Judaism and pagan Satanic Communism.⁵³⁴

V.I. Lenin's maternal grandfather, Isaac Blank, was Jewish. Researcher Wayne McGuire of Harvard University wrote: "Lenin was a Jew by the standards of Israel's Law of Return: he possessed a Jewish grandparent."⁵³⁵ Lenin, in apparent reference to himself, said: "The clever Russian is almost always a Jew or has Jewish blood in him."⁵³⁶ Leon Bronstein (Trotsky), supreme commander of the Soviet Red Army, was also Jewish.⁵³⁷

The Bolshevik revolution was Jewish from top to bottom. Of 556 leading conspirators in the Bolshevik state in 1918-19 there were 17 Russians, two Ukrainians, eleven Armenians, 35 Latvians, 15 Germans, one Hungarian, ten Georgians, three Poles, three Finns, one Czech, one Karaim, and 457 Jews.⁵³⁸ As pointed out by Robert Wilton in his book *The Last Days of the Romanovs*, the communist revolution was not an insurrection by Russians, but rather a secret invasion by Jews. As of 1983, the Premier of the Soviet Union was a Jew (Andropov) and 23 out of 25 members of the Politburo (the Soviet ruling clique) were Jews. In addition, every top member of the Soviet military and police was a Jew.⁵³⁹ Robert Wilton explains:

The Germans knew what they were doing when they sent Lenin's pack of Jews into Russia. They chose them as agents of destruction. Why? Because the Jews were not Russians and to them the destruction of Russia was all in the way of business, revolutionary or financial. The whole record of Bolshevism in Russia is indelibly impressed with the stamp of alien invasion. The murder of the Tsar, deliberately planned by the Jew Sverdlov (who came to Russia as a paid agent of Germany) and carried out by the Jews Goloschekin, Syromolotov, Safarov, Voikov and Yukovsky, is the act not of the Russian people, but of this hostile invader.⁵⁴⁰

Colonel Jack Mohr states: "One of the greatest crimes of the Talmudic Pharisees has been that of bringing communism into power while trying to conceal its Talmudic origin."⁵⁴¹ However, the direct and circumstantial evidence that the communist revolution in Russia was a conspiracy perpetrated by Talmudic Jews is overwhelming. Circumstantial evidence that points to Jewish control of the communist revolution is that once the communists in Russia seized power, the first law they passed made antisemitism a crime punishable by death.⁵⁴² While Christian church buildings were turned into animal stables, slaughter houses, and dance halls, the Jewish synagogues were untouched.⁵⁴³ Christian pastors were removed from their pastoral duties and made to work on roads and in slave labor camps, yet the Jewish rabbis were permitted to continue their clerical duties.⁵⁴⁴ "Some 200,000 (Christian) clergy, many crucified, scalped and otherwise tortured, were killed during the approximately 60 years of communist rule in the former Soviet Union, a Russian commission reported Monday (Nov. 27, 1995) . . . 40,000 churches (were) destroyed in the period from 1922 to 1980."⁵⁴⁵

Historian Michael Hoffman II exposed the hidden meaning behind some of the bloodthirsty communist propaganda:

Lenin declared, "We are exterminating the bourgeoisie as a class." His partner in crime, Apfelbaum (Zinoviev) stated: "The interests of the revolution require the physical annihilation of the bourgeoisie class." Who were these bourgeoisie? Certainly not Jews. Trotsky gave a clue to their identity in a 1937 interview in the New York Jewish newspaper, *Daily Forward*: "The longer the rotten bourgeoisie society lives, the more and more barbaric will anti-Semitism become everywhere."

Bourgeoisie was a Bolshevik code-word for

Gentile. The first law passed after the Communists seized power in Russia made anti-semitism a crime punishable by death. (*Izvestia*, July 27, 1918).

* * *

The Jewish Bolsheviks regarded politics as a branch of Gentile pest control. Hatred of Christians, especially the peasant "bourgeoisie" was their prime motivation. The systematic destruction of the Christian peasantry of Russia as so many vermin, beginning with Lenin's attack on them in the summer of 1918 and his forced starvation in 1921, has been almost completely ignored in Western history.⁵⁴⁶

Henry Makow explains that the brutality of the Bolshevik Revolution in Russia was inspired and led by Talmudic Jews. Makow estimates that the Cheka (later renamed OGPU, then NKVD and finally KGB) was responsible for at least 20 million deaths.⁵⁴⁷ The primary foci of the slaughter were Gentiles in general and Christians in particular. According to Slava Katamidze: "The Church became the target of Bolshevik hostility from the very beginning."⁵⁴⁸

Makow quotes Jewish writer Sever Plocker, who stated that the brutal Cheka was led and staffed mainly by Jews.⁵⁴⁹ The Cheka was empowered by Lenin and Trotsky, who were Illuminati Jews and financed by Illuminati Jewish bankers. "Many Jews sold their soul to the devil of the Communist revolution and have blood on their hands for eternity," Plocker writes. "We mustn't forget that some of the greatest murderers of modern times were Jews."⁵⁵⁰

Plocker gives the example of Genrikh Yagoda, who was

a bloodthirsty Jew who oversaw the slaughter of millions of Russians:

An Israeli student finishes high school without ever hearing the name "Genrikh Yagoda," the greatest Jewish murderer of the 20th Century, the GPU's deputy commander and the founder and commander of the NKVD. Yagoda diligently implemented Stalin's collectivization orders and is responsible for the deaths of at least 10 million people. His Jewish deputies established and managed the Gulag system.⁵⁵¹

Moses Mordecai Marx Levi, alias Karl Marx, was a Jew, a Satanist, and a member of the "League of the Just," which was a branch of the Illuminati.⁵⁵² In 1847, Marx was commissioned by the Illuminati to write the *Communist Manifesto*, which is an outline of their plans for world domination.⁵⁵³

Paragraph seven of Protocol 3 states that the Gentile communists and socialists are dupes that are helping the Zionist Jews bring about the destruction of the Gentiles.

We appear on the scene as alleged saviours of the worker from this oppression when we propose to him to enter the ranks of our fighting forces - Socialists, Anarchists, Communists - to whom we always give support in accordance with an alleged brotherly rule (of the solidarity of all humanity) of our social masonry. The aristocracy, which enjoyed by law the labor of the workers, was interested in seeing that the workers were well fed, healthy, and strong. We are interested in just the opposite - in the diminution, the killing out of the goyim.⁵⁵⁴

The Talmudic Jews have been successful in preventing any revelations about their involvement in establishing a new communist world order by labeling anyone who exposes their efforts an antisemite. What most do not understand is that many who claim to be objects of antisemitism are not Semites at all. Semites are those who are descended from Shem, the oldest son of Noah. Most Jews living in Israel and throughout the world today are eastern European converts to a religion that they call Judaism, but in fact is Babylonian Talmudism. The Europeans who later converted to this Babylonian form of Judaism are known as Ashkenazi or Khazar Jews.

Dr. Benjamin H. Freedman, a former Jew, states that the Khazars were a pagan nation whose religious worship was a mixture of phallic worship and other forms of idolatry. In the 7th century their King Bulkan chose Talmudism, which most now call Judaism, as the state religion.⁵⁵⁵ Today Khazar Jews are called “Yiddish.”

These Ashkenazi Jews are people without any allegiance to any nation. Their primary objective is to own the entire world. To get an idea of the nefarious objective of these Talmudists, let us read an 1879 letter from Baruch Levy to Karl Marx:

The Jewish people as a whole will be its own messiah. It will attain world dominion by the dissolution of other races, by the abolition of frontiers, the annihilation of monarchy, and by the establishment of a world republic in which the Jews will everywhere exercise the privilege of citizenship. In this new world order the children of Israel will furnish all the leaders without encountering opposition. The governments of the different peoples forming the world republic will fall without difficulty into the hands of the Jews. It will then be possible for the Jewish rulers to

abolish private property, and everywhere to make use of the resources of the state. Thus will the promise of the Talmud be fulfilled, in which it is said that when the messianic time is come, the Jews will have all the property of the whole world in their hands.⁵⁵⁶

Many think that communism could not be the work of Talmudic Jews because Russia is allied with the Arab countries. Things, however, are not what they appear. Jack Bernstein, an American Ashkenazi Jew who moved to Israel shortly after its founding in 1948, returned in disgust to the United States after witnessing the duplicity of Israel. He revealed that the aboriginal Jews of Palestine, who are called Sephardic Jews, are discriminated against in modern Israel. They are second class citizens at the bottom strata of society in Israel, along with Christians and Muslims. In his book, *The Life of an American Jew in Racist Marxist Israel*, explains the Machiavellian strategy of Israel.⁵⁵⁷

Bernstein found out that communist Russia's support for the Arab countries is a Jewish subterfuge.⁵⁵⁸ He stated that part of the Machiavellian plan is for communist Russia to appear to support the Arabs by furnishing them with military aid. However, the communists will never provide enough aid to allow the Arabs to destroy Israel. Since 1949, there has been a free-flow of intelligence sharing between Israel and communist Russia.⁵⁵⁹ Bernstein obtained this information directly from the horse's mouth: the Secretary-Treasurer of the Communist Party in Northern Tel Aviv.⁵⁶⁰

Bernstein pointed out that Israel presents itself as a democracy, but in fact Israel is a communist country to its core. He stated that Zionism and communism are one and the same. The purest form of communism is found in Jewish kibbutzim in Israel.

Michael Collins Piper reveals in his book, *Final Judgment*, that Israel's communist ties are not limited to the former Soviet Union. There has been a long, albeit secret, history of mutual cooperation between communist China and Israel in the development of nuclear and other military weapons. In fact, Israel has been cited as one of the primary conduits for the flow of U.S. and other western technologies to communist China.

Jesus was victorious over Satan on the cross. Satan regrouped and attacked the manifestation of Christ on earth, the Christian church. The bible identifies the people Satan used to persecute the church: the Jews. The Jews are the enemies of the gospel of Jesus Christ. For example, in Acts chapters 6 and 7 it explains how Stephen preached the gospel before the Jews. What did the Jews do? They stoned Stephen to death. Jesus identified the Jews thusly: "Ye are of your father the devil, and the lusts of your father ye will do." John 8:44. Jesus was not using hyperbole. The religion of the Jews in fact is the mystical worship of Satan. The Jews must keep that fact secret until they have full control of all of the organs of their planned world government.

According to John Torell, in the Jewish Cabala (a/k/a Kabbalah), the "holy serpent" is trying to set herself free from the bottomless pit. Once she does this she can enter the earth as "the messiah." Cabalists teach that "the messiah" will only appear on earth in one of two ways. One way is for the Cabalistic Jews to destroy all evil on the earth and make it totally good. The other alternative is for the Cabalistic Jews to destroy all good on earth and make it totally evil.⁵⁶¹

The Cabalistic Jews have decided that is harder to make things good and so they have chosen the alternative of destroying all goodness and making the world evil. This Cabalistic religion is grounded in the commission of sins in order to bring about the ascension of their messiah, the "holy serpent," out of the bottomless pit to make "her" appearance on earth. These Jews

believe that only by breaking the laws of God can they serve their god.

Do not think that Jews are ignorant of the fact that Satan is the god of their religion. Harold Wallace Rosenthal, Administrative Assistant to United States Senator from New York, Jacob K. Javits, in a 1976 interview with Walter White Jr. stated: "Most Jews do not like to admit it, but our god is Lucifer."⁵⁶² That explains the revelation by Albert Pike, the theological pontiff of Freemasonry, who said that "[t]he doctrine of Satanism is heresy; and the true and pure philosophic religion is the belief in Lucifer, the equal of Adonay; but Lucifer, God of Light and God of Good, is struggling for humanity against Adonay, the God of Darkness and Evil."⁵⁶³ The evidence is that Freemasonry flows from Cabalistic Judaism. Albert Pike revealed in his doctrinal bible of Masonry, *Morals and Dogma*, that "Masonry is a search for Light. That leads us directly back, as you see, to the Kabalah."⁵⁶⁴ It is necessarily the case that the god of Freemasonry (Lucifer) would be the same as the god in the religious book upon which it is based (the Jewish Kabala).

The modern day Pharisees go to great lengths not only to sin themselves, but also to lead as many others into sin as they serve their evil god, Satan. Jesus revealed their nature when he said to the Pharisees: "Woe unto you, scribes and Pharisees, hypocrites! for ye compass sea and land to make one proselyte, and when he is made, ye make him twofold more the child of hell than yourselves." (Matthew 23:15)

The fact that Judaism is a religion of sin and rebellion that embraces evil is confirmed by Jewish "rabbi" David Cooper, who spent eight years studying the Cabala in Jerusalem's Old City.

The lesson is that even the heart of Satan has a divine spark; even the heart of evil yearns to be redeemed. This is important, because we learn

that our job is not to set up the battleground to eradicate evil, but search out its spark of holiness. Our task is not to destroy but to build.⁵⁶⁵

* * *

The mystical teaching of the Baal Shem Tov, however, presents us with a new paradigm. It says that evil has a divine nature within it. As the Zohar describes, 'there is no sphere of the Other Side (evil) that entirely lacks some streak of light from the side of holiness.' [Zohar II:69a-b] Rather than destroy it, our task is to uplift it.⁵⁶⁶

The purposeful promotion of evil by Jews is the reason that we find vice, death, and destruction, at every turn of the Zionist screw. Near the top of the Zionist power pyramid we find the Rothschild banking family. Henry Makow reveals that the Rothschilds were Sabbatean-Frankists, which is a sect of Judaism. Sabbateans are followers of Rabbi Sabbatai Zevi (1626-1676), who claimed to be the Jewish Messiah. Frankists are followers of Jacob Frank (1726-1791). Frank was a popular Jewish Cabalist, who claimed to be the reincarnation of Sabbatai Zevi. Sabbatean-Frankists are "characterized by their 'liberated' sexual practices, incest, pedophilia, etc. They believed the Messiah would return only when the world descended into sin and chaos. They would advance this process."⁵⁶⁷ Sabbatean-Frankists adhered to the code of "what had been prohibited would be allowed: adultery, incest, pedophilia. (This is the occult origin of our 'sexual liberation.'). Inspired by the Cabala, they practiced 'holiness through sin.' Good would come through the annihilation of Western civilization and the triumph of Evil."⁵⁶⁸

Surely Satan has an end in mind for constructing such a sinister religious doctrine. He does, and it is nothing short of the subjugation of all men under the dictatorial rule of his antichrist!

He uses the escalating sin and crime in society as a justification to bring about more government regulation and control of the masses. As explained by Edmond Burke: “Men are qualified for civil liberty in exact proportion to their disposition to put moral chains on their own appetites. Society cannot exist unless a controlling power upon will and appetite be placed somewhere, and the less of it there is within, the more there is without. It is ordained in the eternal constitution of things that men of intemperate minds cannot be free. Their passions forge their fetters.”

This evil doctrine can also be seen in the Talmud, where incest, fornication, adultery, etc. are promoted as virtues and something to be desired. It is difficult for the Gentile world to fully comprehend what is happening in this Jewish netherworld of conspiracy unless they understand the nature of Cabalistic Judaism. It is a religion that is based on the promotion, propagation, and commission of sin as a means to world domination.⁵⁶⁹

The Cabala, like the Talmud, graphically blasphemes Jesus. For example, in Zohar III, 282a, the Cabala refers to Jesus as a dog who resides among filth and vermin.⁵⁷⁰

Individual Jews can be saved only by the grace of God through faith in Jesus Christ. Such a saved Jew will reject Judaism, just as a saved Satanist will reject Satanism. Judaism is irreformable. The Jews who follow Judaism to their death will die in their sins. Such Jews are described by Stephen as stiff-necked people, who are in perpetual rebellion against God.

Ye stiffnecked and uncircumcised in heart and ears, ye do always resist the Holy Ghost: as your fathers did, so do ye. Acts 7:51.

Henry Makow, in his book *Illuminati, The Cult that*

Hijacked the World, explains the occult nature of Judaism.

The "secret society" appears to be the organizational model for Judaism as well as Freemasonry, Zionism and Communism (which are Masonic orders.). Essentially, the leadership deceives and manipulates the membership with idealistic-sounding goals. Only those corruptible (and blackmail-able) are let in on the true agenda and allowed to rise.

This model now applies to the whole world. "Successful" people have often accepted the Devil's Bargain- "Serve me and I will give you the world."

This view of Judaism is confirmed by the author of the "Protocols of Zion" who says:

"No one will ever bring under discussion our faith from its true point of view since this will be fully learned by none save ours, who will never dare to betray its secrets." (Protocol 14)

* * *

Edith Starr Miller, an expert on religion and the occult, called Judaism "a secret society posing as a religion," and "a sect with Judaism as a rite."

The real purpose of Judaism and all secret societies, Miller says, is to con people into advancing the agenda of the super rich. "Regardless of their exoteric objects, the esoteric aims of most societies are all directed toward the same end, namely: the concentration of political,

economic and intellectual power into the hands of a small group of individuals, each of whom controls a branch of the International life, material and spiritual, of the world today." ("Occult Theocracy," 1933, p.661)

Flavien Brenier compares the goals of Judaism with Freemasonry: securing political power and gradually modifying "the conceptions of the people in the direction of their secret doctrine." ("Occult Theocracy," 80)

The secret aim of Judaism is the same as Freemasonry.⁵⁷¹

Part and parcel of Zionism is the Judaic religious philosophy based upon the occult worship of a type of god known as an egregore. An egregore is an autonomous god of the collective group mind. The egregore influences the thoughts of a group of people. In the case of Judaism, it is the Jewish people. Henry Makow opines that this Judaic egregore is Lucifer:

Perhaps the Jewish elite has a different God. A reader, "George," knew the heiress of a rich Jewish banking family "not the Rothschilds, although her family dwelled in a palace neighbouring the Rothschilds."

"Leah was one of my classmates in the Geneva University (Switzerland) where I was studying psychology . . . She was an attractive blue-eyed blonde lady. . . . As she was wearing a Star of David, I asked if she was a believer. She answered "yes and no" and added that she believed in a god of the Jews who was serving the Jews rather than served by them. I

immediately asked whether she was speaking of an egregore . . . Her only response was "yes" and she broke that conversation. Never again did we mention the subject."⁵⁷²

* * *

George speculates that elite Jews created the Jewish God as their "egregore," i.e., an instrument of their collective will, i.e., their desire to vanquish the heathens and rule supreme:

"Could it be possible that the ancient Levite priests found a way to create a supernatural entity from the collective mind of the tribe of Judah? An entity born from a collective mind the Levites were shaping into self-isolationism and segregationist a.k.a., extreme ethno-centrism? . . . An entity designed to help the "chosen people" destroy the 'alien' nations and provide it with material rewards? An entity resulting from the black magic of the Levite priests who, as the first indoctrinated atheists, were denying the universal God of Moses because they didn't want to submit to a 'Lord and Master' but rather become themselves 'Lords and Masters' through their slavish 'egregorious' god?"

This "egregore" is Lucifer. Elite Jews have made him the master meme of the New World Order. The elite Jews are the "Communist Capitalist International," the intermarried German Jewish banking families who, according to Christian Rakovsky include the Rothschilds, Warburgs, Schiffs and many others.

They have also intermarried with the corrupt gentile elites of Europe and America, many of whom think they are Jews.⁵⁷³

All egregious gods are evil and under the command of Satan. The Jewish egregore is viewed within Jewry as a serpent that is gaining control of nation after nation as it slithers across the globe in its journey toward world domination. Texe Marrs reveals: “In the religion of Judaism, the Sacred Serpent is said to rise from the abyss. Through his power and guidance, a divine World Jewry will triumph over the Gentiles, and the Jews’ Messiah will reign supreme.”⁵⁷⁴ Makow’s opinion that the egregore of Judaism is Lucifer is perceptive, since Lucifer controls all egregores. That fact is implicitly supported by the writings of eminent Jewish Rabbis. Texe Marrs explains:

Take, for example, the celebrated rabbi known throughout the Jewish religious world as the “Gaon of Vilna.” It was he who taught of the Kabbalah’s doctrine that inside Judaism’s vaunted Tree of Life there resides a great and Sacred Serpent whose masculine name is Leviathan and whose feminine name is Malkut. It is this Sacred Serpent, the Kabbalah teaches, that in the coming Messianic age shall rise from the abyss to conquer the Gentiles and exalt God’s Chosen, the Jews. This Leviathan, the holy and piercing serpent, is the expected Messiah prophesied to appear, the one who will supernaturally possess the bodies of the world’s Jews and lead them to global domination and glory.

This strange doctrine, accepted by the vast majority of today’s Orthodox Rabbis, also makes the bold claim that the Jews are a Holy Race of

wise and virtuous serpent beings. Collectively, World Jewry is claimed to be the very incarnation on earth of the Holy Serpent.

Could this be what the true Messiah and Lord of the Universe, Jesus Christ, meant when he confronted the wicked pharisaic Jews—equivalent to today's Orthodox Jewry—by flatly declaring:

“Ye serpents, ye generation of vipers, how can ye escape the damnation of hell?” (Matthew 23:33)

* * *

The Jews themselves, in their devilish religion of Judaism, admit their god is the Serpent. Their leaders well know that this is the Devil, or Satan. In some type of creepy and eerie doctrinal confession, the rabbis are even discovered to be boasting of their Sacred Serpent and they say that all Jews live inside its belly! Is this not unbelievable and revelatory?⁵⁷⁵

Who do we see described in the bible as the serpent? It is none other than Satan himself. “And the great dragon was cast out, that old serpent, called the Devil, and Satan, which deceiveth the whole world: he was cast out into the earth, and his angels were cast out with him.” Revelation 12:9.

The earthly god of Judaism, who is androgynous, is known as Leviathan or Malkut.⁵⁷⁶ Leviathan is an evil god, adopted by the rabbis as the god of the Jews during their captivity in ancient Babylon.⁵⁷⁷

The occult Judaism, which is hidden from the uninitiated,

is that the Jews view themselves as the very manifestation of their egregore god, whom they call Leviathan. This collective god, Leviathan, also known as the “holy serpent,” will subjugate the world under the rule of the Jews.

The egregore of the Jews is confirmed in paragraph one of Protocol 3 in the Protocols of the Learned Elders of Zion, which refers to the “Symbolic Snake” and depicts it as an egregious symbol of the Jewish people:

Today I may tell you that our goal is now only a few steps off. There remains a small space to cross and the whole long path we have trodden is ready now to close its cycle of the Symbolic Snake, by which we symbolize our people. When this ring closes, all the States of Europe will be locked in its coil as in a powerful vice.

Professor Nilus in the epilogue to the 1905 edition of his book, *The Great Within the Small*, explains the symbolism of the snake with the head of the snake being those initiated in the Zionist plan to conquer the world and the body of the snake being the mostly unwitting body of Jewry. The snake symbolized the slyness of the Jews to penetrate into the hearts of nations in order to undermine and subdue them under Jewish power. Nilus’ describes the egregious “Symbolic Snake” as follows:

[T]he Symbolic Snake, whose head was to represent those who have been initiated into the plans of the Jewish administration, and the body of the Snake to represent the Jewish people—the administration was always kept secret, even from the Jewish nation itself. As this Snake penetrated into the hearts of the nations which it encountered, it undermined and devoured all the non-Jewish power of these States.⁵⁷⁸

After the Bolshevik Revolution in Russia, Professor Nilus was arrested by the Cheka, imprisoned, and tortured. Bolshevism is Communism. Communism is simply government by the principles of the Jewish Talmud. The Jewish president of the court told Professor Nilus that the brutal treatment he received was as retribution for having done the communists incalculable harm in publishing the *Protocols of the Learned Elders of Zion*. The Protocols exposed the details of the plot by elite Jews to subjugate Gentiles and rule the world. Professor Nilus was released for a few months, but was soon rearrested by the Cheka. He was confined in prison until February 1926. He died in exile in the district of Vladimir on January 13, 1929. The treatment of Professor Nilus by the Jewish Bolsheviks speaks clearly to the authenticity of the *Protocols of the Learned Elders of Zion*.

John Torell has revealed that in the Jewish Cabala, the “holy serpent” is mystically trying to set itself free from the bottomless pit in order to enter the earth as “the messiah.”⁵⁷⁹ The “holy serpent” of the Jews is an egregious god, which means the Jews believe they are their own messiah. In 1879 Baruch Levy wrote to Karl Marx and stated that the Jews will, in the end, have all of the world’s property in their hands. Levy stated that the promise of the Talmud would then be fulfilled, which is that “the Jewish people as a whole will be its own messiah.”⁵⁸⁰

The Messianic promise of the Talmud to which Levy referred can be found in the Babylonian Talmud at Folio 111a of Tractate Kethuboth, where it states in pertinent part: “We have a tradition that Babel will not witness the sufferings that will precede the coming of the Messiah.” A footnote to that passage explains: “These are the throes of mother Zion which is in labor to bring forth the Messiah - without metaphor, the Jewish people.” The Jewish hierarchy plan to establish a Messianic reign over a new world order tyranny from their earthly Zion in Israel.

What does the bible say about Leviathan? In Job 41:34

we read that “He beholdeth all high things: he is a king over all the children of pride.” God has stated that “[p]ride goeth before destruction, and an haughty spirit before a fall.” Proverbs 16:18. Whereas, Jesus Christ calls on his followers not to be prideful, but rather to be humble. “Whosoever therefore shall humble himself as this little child, the same is greatest in the kingdom of heaven.” Matthew 18:4.

So, we know that the Leviathan, who is king over the children of pride, must be the very opposite of God. Leviathan must be “the great dragon was cast out, that old serpent, called the Devil, and Satan” mentioned in Revelation 12:9.

Please note that it was the serpent in the garden of Eden who beguiled Eve. The serpent was the most subtle of the beasts. He told Eve that she and Adam could become as gods if they ate the fruit from the tree. Genesis 3:4-5. That is exactly what the Jews are claiming for themselves. They have believed the lie of the serpent that they are gods. Each Jew believes that he is a god who is part of the collective Jewish eggregorious god. The Jewish view of themselves as gods is found in the Jewish religious doctrine. For example, the Talmud at Tractate Sanhedrin, Folio 58b refers to Jews as a “Divine Presence.”⁵⁸¹ Rabbi Shimon ben Yohai declared his godhood by stating: “I am beyond the jurisdiction of any angel or judge in heaven.”⁵⁸²

Satan is the adversary of God. He tries to be like God and his earthly kingdom is a devilish imitation of God’s heavenly kingdom. God’s kingdom is a spiritual kingdom that is not of this earth. John 18:36. God has a heavenly Jerusalem (containing a heavenly Zion). Revelation 21:10. Satan’s kingdom is a kingdom of the flesh that is headquartered in the earthly Jerusalem (containing an earthly Zion). The gospel of Jesus Christ explains that Jesus is in believers and believers are in Jesus. John 14:20; 17:20-23. There is one spiritual body of Christ, with Jesus the head. Colossians 1:18. As with the earthly imitation Zion, Satan

also has a fleshly imitation body of satanic believers. That body is not a spiritual body. It is the fleshly body of the Jews. It is the egregore of the "holy serpent" of the Jewish people. As the church is the body of Christ, so also in a perverse way is the egregore of the Jews the body of Lucifer.

The Jewish egregore, or group god, is a communist beast that is kept together through antisemitism. Antisemitism is the means by which the head of the snake keeps the body of Jews following in lockstep its leadership. Without antisemitism, the body of Jews would disperse and be assimilated into the Gentile nations. That simply cannot be allowed by the Jewish hierarchy. The Jews must be kept as an insular body separated from the Gentiles. The power of the Jewish hierarchy is centered in its control of the egregorious body of Jews. Henry Makow explains:

[Nicholas] Lysson discusses how the Jewish leadership actively provoke anti-Semitism because it is indispensable for Jewish cohesion and survival. Jews acknowledge this. Are they saying that, without its "egregore" i.e. its predatory agenda, Jews would have no corporate raison d'etre? Of course this secret is kept from the rank-and-file, as in Freemasonry which Rakovsky said is designed to bring about "the triumph of Communism."⁵⁸³

The language of witchcraft always carries two meanings. There is the exoteric meaning for the uninitiated public, and there is the esoteric meaning that is only understood by the inner circle of initiates. For example, Jewish communists claim that they are atheists. That is the exoteric meaning of communist doctrine. However, the occult meaning of communism is hidden. The esoteric meaning of communism is that the collective body of Jews make up the egregore, who is the collective god of communism. So when communists talk about atheism, they only

mean that there is no God outside of themselves. The egregore, however, only includes the Jewish communists; the Gentile communists are simply the skin of the serpent that will ultimately be shed after they have served their purpose.

As of the year 2000 there were 268 kibbutzim in Israel.⁵⁸⁴ A Kibbutz is a collective Jewish society. According to the Jewish Virtual Library, Kibbutz is “the fulfillment of the idea ‘from each according to his ability, to each according to his needs.’”⁵⁸⁵ That is a direct quote from Karl Marx.⁵⁸⁶ The Kibbutz collective is the purest form of communism. The Kibbutz is one manifestation of the Jewish egregore. When the Jewish egregore is allowed unrestrained aggression against Gentiles, the exoteric term used to describe it is “communism.” It is not a surprise that as one gets closer to the head of the egregorious serpent in Israel, we find the purest form of communism.

What does this Jewish egregore leave in its path? History has shown that it is nothing but merciless death and destruction. The egregorious religious doctrine of the godhood of the Jews is how the Jewish communists could be so bloodthirsty. They do not believe that there are any moral constraints on their conduct. They are imbued with an ethnic superiority complex, where they are gods over the Gentiles. They view Gentiles, particularly Christians, as their enemies to be enslaved and exterminated. Makow explains:

The greatest mass slaughter in history was not the Jewish holocaust but the Ukrainian holodomor, i.e., the "hunger." By Stalin's own estimate, ten million Ukrainians died, mostly at the hands of Bolshevik Jews.

The holodomor took place because the Bolsheviks confiscated all the grain. Lysson writes:

"A quarter of the rural population, men, women and children, lay dead or dying in a great stretch of territory with some forty million inhabitants, like one vast Belsen. The rest, in various stages of debilitation, had no strength to bury their families or neighbours. [As at Belsen] well-fed squads of police or party officials supervised the victims."

The extermination of the Ukrainian Kulaks was directed from the Kremlin where the Bolshevik leadership lived in family apartments and maintained a fraternal atmosphere suffused by collectivist idealism, i.e., their *egregore*. This is how historian Simon Sebag Montefiore, the scion of an elite British Jewish family, describes the scene during the holomodor. Of course he doesn't mention that most of the main players were Jews.

"The Party was almost a family business. Whole clans were members of the leadership. . . . This pitiless fraternity lived in a sleepless frenzy of excitement and activity, driven by adrenalin and conviction. Regarding themselves like God on the first day, they were creating a new world in a red-hot frenzy." ("Stalin: The Court of the Red Tsar," p. 40, 45)

The Soviets didn't raze synagogues because Communism expressed the Jewish *"egregore"*. Christians and Jews apparently do not worship the same God. The Christian God represented by Jesus is universal love and brotherhood. The Jewish God has been supplanted by a Cabalistic *egregore* that "serves" elite Jews only. It represents their ruthless sociopathic urge for

world dominion. The same egre-gore- the desire to supplant God- animates the New World Order.⁵⁸⁷

The idealism of brotherhood and comradery that is commonly propagandized in communist circles is just so much window dressing that conceals a satanic deception. The real agenda of communism is the destruction of religion, family, and nation; the accumulation of all wealth and the enslavement of mankind.⁵⁸⁸

The idealistic Gentile followers of communism are dupes, who are viewed by the Jewish leaders as “useful idiots,” who will be summarily executed when the Jews come to power. That has been the pattern in all communist revolutions in the past, and it will continue to be the practice in the future. The Zionist Leviathan is a cunning and diabolical egre-gorious viper bent on nothing short of world rule based upon Jewish supremacy.

The core doctrine of Judaism is the rejection of Jesus Christ. Harmony Daws explains that the Jewish religion is diametrically opposed to Christianity.

As we have said many times, the modern Jewish religion is extremely aware of the inherent hostility between itself and Christianity. The two faiths could hardly be more opposed in their basic tenets. Judaism absolutely rejects the deity of Christ, which is (or should be) the central foundation on which all other Christian beliefs are built. Modern Judaism exalts the Jewish people as the correct representations of God in this world while Christians call for a spiritual revolution that extends to all people of all races. Jewish leaders and sacred texts know that these two faiths are diametrically opposed; unfortunately, Christians seem completely

Jesus criticized the Pharisees for their religious traditions. Those traditions were oral traditions at that time. Later they were memorialized in the Talmud and the Kabbalah (a/k/a Cabala). The Kabbalah and the Talmud today span numerous volumes. Jesus called the Pharisees hypocrites, who masqueraded as religious men, but who were in reality irreligious frauds.

Then came to Jesus scribes and Pharisees, which were of Jerusalem, saying, Why do thy disciples transgress the tradition of the elders? for they wash not their hands when they eat bread. But he answered and said unto them, **Why do ye also transgress the commandment of God by your tradition?** For God commanded, saying, Honour thy father and mother: and, He that curseth father or mother, let him die the death. But ye say, Whosoever shall say to his father or his mother, It is a gift, by whatsoever thou mightest be profited by me; And honour not his father or his mother, he shall be free. **Thus have ye made the commandment of God of none effect by your tradition. Ye hypocrites,** well did Esaias prophesy of you, saying, This people draweth nigh unto me with their mouth, and honoureth me with their lips; but their heart is far from me. **But in vain they do worship me, teaching for doctrines the commandments of men.** (Matthew 15:1-9)

The Pharisees had an outward appearance of piety, in order to gain political and religious control of the Jews. In secret, however, they practiced an occult doctrine that was only known to its initiates. Lady Queenborough (Edith Miller) explains in her book *Occult Theosophy*:

The Chaldean science acquired by many of the Jewish priests, during the captivity of Babylon, gave birth to the sect of the Pharisees whose name only appears in the Holy Scriptures and in the writings of the Jewish historians after the captivity (606 B. C). The works of the celebrated scientist Munk leave no doubt on the point that the sect appeared during the period of the captivity. "From then dates the Cabala or Tradition of the Pharisees. For a long time their precepts were only transmitted orally but later they formed the Talmud and received their final form in the book called the *Sepher ha Zohar*."⁵⁹⁰

The scrupulous observance by the Pharisees of Jewish religious tradition was only a cover for their secret doctrine. They had rejected Jehovah and had adopted the pantheism of Babylon. They pretended that their many rituals were necessary for the worship of Jehovah, but those were only man-made rules to conceal their secret Babylonian religion. Jesus rebuked them for it, calling them hypocrites for their vain worship of God through man-inspired rituals and honoring God with fine words, when their hearts in fact were focused on the heathen gods of Babylon. See Mark 7:5-7. The Pharisees had accepted the satanic lie that they had become "as gods." See Genesis 3:5. Their new Babylonian (a/k/a Chaldean) religion was to be exclusive to the Jews, who were to rule the world. Edith Miller explains:

The Pharisees, then, judging it wiser to capture the confidence of their compatriots by taking the lead in the religious movement, affected a scrupulous observance of the slightest prescriptions of the law and instituted the practice of complicated rituals, simultaneously however cultivating the new doctrine [i.e., secret doctrine] in their secret sanctuaries. These were regular

secret societies, composed during the captivity of a few hundred adepts. At the time of Flavius Josephus which was that of their greatest prosperity, they numbered only some 6,000 members. This group of intellectual pantheists was soon to acquire a directing influence over the Jewish nation. Nothing, moreover, likely to offend national sentiment ever appeared in their doctrines. However saturated with pantheistic Chaldeism they might have been, the Pharisees preserved their ethnic pride intact. This religion of Man divinised, which they had absorbed at Babylon, they conceived solely as applying to the profit of the Jew, the superior and predestined being. The promises of universal dominion which the orthodox Jew found in the Law, the Pharisees did not interpret in the sense of the reign of the God of Moses over the nations, but in that of a material domination to be imposed on the universe by the Jews. The awaited Messiah was no longer the Redeemer of original Sin, a spiritual victor who would lead the world, it was a temporal king, bloody with battle, who would make Israel master of the world and 'drag all peoples under the wheels of his chariot.' The Pharisees did not ask this enslavement of the nations of a mystical Jehovah, which they continued worshipping in public, only as a concession to popular opinion, for they expected its eventual consummation to be achieved by the secular patience of Israel and the use of human means.⁵⁹¹

Jesus cursed the Pharisees to their face: "Woe unto you, scribes and Pharisees, hypocrites! for ye are as graves which appear not, and the men that walk over them are not aware of

them.” (Luke 11:44) The Babylonian traditions of the Pharisees, which were traditions passed down orally from generation to generation, were eventually (in part) memorialized in the Kabbalah and Talmud. The double aim of the Pharisees was to wrestle political control over the Jews from the Sadducees and “to modify gradually the conceptions of the people in the direction of their secret doctrine.”⁵⁹² They accomplished both goals. Today Orthodox Jewry is an insular authoritarian society that is completely given over to the practice of the Babylonian religion of the ancient Pharisees.

The twisted Babylonian god of modern Jewry as expressed in the Talmud and Kabbalah is a god of vengeance and hatred of Gentiles and particularly Christians. Edith Miller summarizes the nature of the Jewish god as being “just and merciful only to his own people, but foe to all other nations, denying them human rights and commanding their enslavement that Israel might appropriate their riches and rule over them.”⁵⁹³

The Talmud sets forth clear distinctions between Gentiles and Jews. Jews are viewed as gods, whereas Gentiles are viewed as animals. For example, in Talmud Tractate Sanhedrin, Folio 58b it states that smiting a Jew on the jaw is like assaulting a “Divine Presence.”⁵⁹⁴ If the assailant happens to be a gentile, he is “worthy of death.”⁵⁹⁵ A Gentile child is considered to be subhuman.⁵⁹⁶

Judaism is a religion of hate. The hatred of Christians and all Gentiles of all races runs through the warp and woof of Judaism. The Jews recite *Amidah*, which is a set of eighteen (by some accounts nineteen) weekly Jewish prayers. The twelfth prayer is called *Birkat ha-minim*. The *Birkat ha-minim* is actually a hateful curse against heretics and enemies of the Jews, particularly Christians. The curse was first introduced in the *Amidah* in the first century at Jabneh by Samuel ha Katan, at the request of Rabban Gamaliel II in order to drive followers of Jesus Christ from the synagogues.

The book of Acts records the successful efforts of the early Christians in converting Jews to Christianity. The early Christian disciples would meet with the Jews in the synagogues and explain the gospel. Many Jews became followers of Christ. Acts 17:1-13. The bible records that the chief ruler of the synagogue at Corinth believed in Jesus and was saved. Acts 18:8. The Jewish leadership saw Christianity as a threat to Judaism and could not allow the spread of Christianity to continue. They instituted the *Birkat ha-minim* as a means of making clear to the Jews that Judaism was incompatible with Christianity. They wanted to keep the newly converted Christians out of the synagogue and stop Christianity from spreading.

Min is a pejorative that is commonly used to refer to a Christian, with *minim* being the plural form of *min*. According to the Encyclopedia Judaica, the *Birkat ha-minim* has to be recited during public worship by the *hazzan* so as to avoid any suspicion of heresy.⁵⁹⁷ The *hazzan* is a Jewish cantor who leads the congregation in prayer. If the *hazzan* makes an error and omits the *Birkat ha-minim*, he is required to return to the *Birkat ha-minim* and recite the curse. That regulation requiring return to the omitted curse does not apply to any of the other benedictions recited as part of the *Amidah*.⁵⁹⁸

Not only do Jews include curses against Christians in their weekly prayers, they have corrupted the yearly Passover celebration into a hate-fest against Christians. Ariel Toaff, explains in his book *Pasque di Sanguie (Blood Passover)*, that in orthodox Judaism Passover has become a ritual of detestation against Jesus.⁵⁹⁹

Ariel Toaff is a professor of Jewish renaissance and medieval history at Bar Ilan University⁶⁰⁰ in Israel, just outside of Tel Aviv. Professor Toaff is a Jewish insider, who comes from a rabbinic bloodline that is highly respected among Jews. He is the son of one of the most revered rabbis in the world, Elio Toaff. He

is the former chief rabbi of Rome and was considered the dean of Italian Jewry. Some have called Elio Toaff the “Pope of the Jews.” So influential was Rabbi Toaff in Rome, he was one of only two people that Pope John Paul II mentioned by name in his will.⁶⁰¹

Toaff explains how over time Judaism and the Passover memorial in particular had been corrupted into a hate-fest against Christ and Christians.

In this Jewish-Germanic world, in continual movement, profound currents of popular magic had, over time, distorted the basic framework of Jewish religious law, changing its forms and meanings. It is in these "mutations" in the Jewish tradition – which are, so to speak, authoritative – that the theological justifications of the commemoration in mockery of the Passion of Christ is to be sought, which, in addition to its celebration in the liturgical rite, was also intended to revive, in action, vengeance against a hated enemy continually reincarnated throughout the long history of Israel (the Pharaoh, Amalek, Edom, Haman, Jesus).⁶⁰²

Toaff explains that the Passover meal was transformed into a ceremonial curse upon Christians. He explains how during the middle ages, the orthodox Jews sprinkled the Passover table with wine to signify the blood hatred of Christians by the vengeful Jews. The Jews made wine an integral part of the ceremony of Passover, which is intended as a disdainful twist on the last supper of Christ. Wine was not part of the Passover celebration as laid down by God. The Passover was intended to be a memorial that was to celebrate God having freed the Jews from Egyptian slavery. Passover also looked forward to the coming of Christ, who is the sacrificial Lamb of God, who takes away the sins of the world. *See John 1:29.*

The fourteenth day of the first month is the Passover (Leviticus 23:4-5, Exodus 12:17-18). Passover is immediately followed by the seven days of unleavened bread (Leviticus 23:6-7, Exodus 12:15-16). There is no mention of using wine as part of the Passover ceremony. Jesus instituted wine at the last supper. Matthew 26:27-29. The Jews have now instituted wine as an integral part of their Passover ceremony; it is intended as a contemptuous mockery of the last supper. The Passover ceremony included cursing Christians with the ten curses that were brought upon Egypt during the Jewish captivity there. Toaff explains:

At this point, in the traditional reading of the *Haggadah*, according to the custom of the Ashkenazi Jews, the curses against the Egyptians were transformed into an invective against all the nations and enemies hated by Israel, with explicit reference to the Christians.⁶⁰³

Toaff was quick to point out that this cursed ceremony was not practiced by the Sephardic or Italian Jews, but as far as he knew, it was only practiced among the German Orthodox Ashkenazi Jews. Toaff explained that the Ashkenazi tradition was that the head of the family would state at the table: "Thus we implore God that these ten curses may fall on the gentiles, enemies of the faith of the Jews."⁶⁰⁴ Toaff stated that was a clear reference to the Christians. The orthodox Jews call on God to cast his anger upon the Gentiles and let the fury of his anger persecute and destroy them.⁶⁰⁵

Toaff came to the ineluctable conclusion, based upon careful examination of authoritative evidence, that in the middle ages blood from Christian boys, who were ritually murdered, was used in some orthodox Jewish communities as part of the yearly Passover ceremony.

The Passover of the bible had been twisted by the

orthodox Jews and turned into an anti-ritual re-enacting the crucifixion of the hated Jesus. Witness testimony establishes that the children were not simply kidnapped and quickly killed. They were brutally and sadistically tortured in a satanic ritual that was intended to be an insult to Jesus Christ.⁶⁰⁶ Taoff states that Jews are obsessed with hatred for Jesus Christ and Christians. Taoff explains the anti-Christian symbolism of the ceremony:

The memorial of the Passion of Christ, relived and celebrated in the form of an anti-ritual miraculously exemplified the fate destined for Israel's enemies. The blood of the Christian child, a new *Agnus Dei*, and the eating of his blood, were premonitory signs of the proximate ruin of Israel's indomitable and implacable persecutors, the followers of a false and mendacious faith.⁶⁰⁷

Toaff explained the horrifying facts that the young victim was kidnapped by the Jews and subjected to a ritualized torture, symbolizing the torments of Christ. The ritual was passed down through oral tradition from generation to generation, from rabbi to rabbi.

Samuele vaguely attributed these traditions to the rabbis of the Talmud (*Iudei sapientiores in partibus Babiloniae*), who were said to have introduced the ritual in a very remote epoch, "before Christianity attained its present power." Those scholars, united at a learned congress, were said to have concluded that the blood of a Christian child was highly beneficial to the salvation of souls, if it was extracted during the course of a memorial ritual of the passion of Jesus, as a sign of contempt and scorn for the Christian religion. Over the course of this

counter-ritual, the innocent boy, who had to be less than seven years old and had to be a boy, like Jesus, was crucified among torments and expressions of execration, as had happened to Christ.⁶⁰⁸

It should be noted that many Jews disagreed with such a macabre ritual and did not follow the practices testified to during the many trials of the Jews. In fact, evidence was introduced on one case, that two Jews who were approached to help in kidnapping a child, refused to assist in the effort and argued against doing so. Toaff points out that the practice of the ritual use of the blood of a Christian child in the Jewish Passover meal was only practiced by fundamentalist orthodox Ashkenazi sects.⁶⁰⁹ Toaff states that the orthodox Jews were the most assertive and controlling. "Medieval Ashkenazi Judaism made up a hermetically sealed orthodoxy, which fed upon itself, confined by a myriad of minute ritualistic regulations, which they considered binding on all, the mere memorization of which constituted an arduous and almost impossible task."⁶¹⁰

Cardinal Ganganelli, who later became Pope Clement XIV, conducted an investigation of ritual murder by the Jews. His report on the matter was supposed to be a political accommodation to the Jews, to provide an official exoneration of them in response to the public clamor over their ritual murders. Cardinal Ganganelli did his duty to the Jews as far as his conscience would allow. He opined that it was not a certain and common axiom among Jews to engage in ritual murder of children. However, the evidence of the ritual murder by Jews of Simon of Trent and Andreas of Rinn was so compelling that Cardinal Ganganelli had to admit that those cases were in fact ritual sacrifices of children by the Jews. Cardinal Ganganelli, in the face of overwhelming evidence, made the following concession to the truth by stating in his 19 January 1760 report: "I admit, then, as true, the fact of the Blessed Simon, a boy three years old, killed by the Jews in Trent in the year 1475

in hatred of the faith of Jesus Christ ... I also admit the truth of another fact, which happened in the year 1462 in the village of Rinn, in the Diocese of Brixen, in the person of the Blessed Andreas, a boy barbarously murdered by the Jews in hatred of the faith of Jesus Christ.”⁶¹¹

Previously Pope Gregory XIII (1572-85) had recognized Simon as a martyr. Pope Gregory, himself, visited the shrine to Simon. His successor, Pope Sixtus V (1585-90), ratified the cult of St. Simon in 1588, allowing the celebration of mass in his name. Pope Benedict XIV (1740-58) confirmed the cult of Saint Simon through his Bull *Beatus Andreas*, which beatified both Simon of Trent and Andreas of Rinn.⁶¹² The power of the Jews over the Catholic Church was finally brought to bear to suppress the historical evidence of ritual murder. In 1965, the Catholic Church outlawed the cult of Saint Simon. The church officials had the remains of the child removed and dumped in a secret place to avoid any resumption of pilgrimages to his grave.

The ritual sacrifice of Gentile children by the Jews has led to repeated banishment of Jews from one nation after another throughout history. For example, on March 31, 1492, King Ferdinand and Queen Isabella banished the Jews from Spain for their wickedness, which included ritual murder. In reference to ritual murder by Jews, the banishment edict states that “whenever a grave and detestable crime is committed by some members of a given group, it is reasonable that the group be dissolved or annihilated.”⁶¹³ Respected historian William Thomas Walsh, in his book, *Isabella of Spain*, states that the detestable crime mentioned in the edict was the 1492 ritual murder by Jews of Christopher of Laguardia. Christopher of Laguardia was later made a Catholic Saint. It was not until 1967 that Jews were officially allowed back into Spain.

In 1911, a Jew, Menachem Mendel Beiliss, was accused of the brutal ritual murder of a young boy named Andrei

Yustshinsky. As was the practice in such cases, powerful Jews were mobilized worldwide in an effort to see that the Jewish defendant was exonerated. The best Jewish lawyers were hired for the defense. Witnesses and officials were bribed.⁶¹⁴ A high ranking police investigator was caught planting evidence that would benefit the defendant.⁶¹⁵ Assassins were employed to poison key witnesses who could not be bribed. For example, three children who witnessed Beiliss abduct Andrei Yustshinsky were given cake by an investigator; the next day, all three fell ill.⁶¹⁶ Two of the children subsequently died, and the third was sick for months. It is estimated that the equivalent of \$115 million in today's dollars was spent on the effort to see that the Jewish defendant was exonerated.⁶¹⁷

Ultimately, the jury concluded that the boy was the victim of Jewish ritual murder, but they could not rule for sure that the defendant was among the Jews who actually wielded the instrument that murdered the child. The jury vote was 6-6; a simple majority was needed to convict in Russia. Matt Hale states that "it was proven to have taken place inside the synagogue at the Jewish-owned Zaitsev factory; the jury could not determine for certain that Beiliss was the one who wielded the awl, causing Andrei to be punctured over 45 times around his body, in an effort to procure as much blood as possible."⁶¹⁸

Czar Nicholas II commissioned the prosecuting attorney, G. G. Zamyslovsky, to write a book about the proceedings. Zamyslovsky produced a 500 page book about the trial. It was published on the eve of the Bolshevik Revolution in Russia.⁶¹⁹ Bolshevism is Communism. Communism is simply Judaism enshrined as government, and it is of, by, and for the Jews. The very first kangaroo court held after the communist revolution in Russia was the trial of G. G. Zamyslovsky. Zamyslovsky was arrested, and after a show trial, he was executed for having the temerity of revealing the facts of the Jewish ritual murder of Andrei Yustshinsky.⁶²⁰ Zamyslovsky's book was suppressed by

the communists. The book has recently surfaced in the original Russian language text.⁶²¹ As of 2015, a complete English translation of the book has been completed, but as of this writing, it has not yet been published.⁶²²

The infamous Jewish ritual murder of a Catholic Priest known as Father Thomas and his servant was reported in April 6, 1850, edition of The New York Herald:

[W]ho would have dreamt of beholding the bloody mysteries of the Talmud exposed in their turn, and of having the trial of one of the most savage and ferocious murders ever yet recorded in the annals of criminality, once more brought before the public? Who would have imagined that certain fanatics use human blood to moisten their holy unleavened bread?

Our readers will undoubtedly recollect the universal sensation created throughout the world, by the discovery of Father Tommaso, a Christian missionary from Sardinia, and his servant, Abraham Amara, who had been bled to death, their limbs chopped off joint by joint, their bones pounded in the mortar, and their mutilated remains thrown into a drain in the city of Damascus.

The manuscripts of the original trial, as sealed by the French and Austrian consuls of that city, are now in this city, and we can thereby defy the 'Great Nation' to contradict the truth of our statements.⁶²³

Toaff explained that only a small nut-sized amount of dried blood was shaken from a glass vial into the wine. The head

of the family would announce: “This is the blood of a Christian child.” He then would recite the ten plagues of Egypt as curses against Christians and gentiles. Toaff states:

The head of the family takes a bit of the blood of the Christian child and drops it in his glass full of wine [...] then, putting his finger in the wine, with that wine where the blood of the Christian child has been shaken, he sprinkles the table and food on the table with it, pronouncing the Hebraic formula in commemoration of the ten curses, which God sent to the refractory Egyptian people who refused to liberate the Jewish people. At the end of the reading, the same head of the family, referring to the Christians, utters the following words (in Hebrew): ‘thus we beseech God that he may similarly direct these ten curses against the gentiles, who are enemies of the Jewish faith.’

Toaff obtained evidence of the Jewish practice of a blood Passover from testimony of Jewish witnesses at the trial of the murder of a Christian child in the 1400's. Expert testimony of Mosè of Würzburg at trial explained that “the Jews naturally require the blood of a Christian child, but if they were poor and could not afford any blood, they were relieved of the expense.”

The witnesses at the trial testified that a small amount of blood of the Christian child was also mixed with the dough of the unleavened bread that was eaten during the Passover meal. There was testimony from a witness named Israele, who was identified as Samuele of Nuremberg’s son, who stated that the mixing of the blood into the unleavened bread was a memorial of the blood with which the Lord commanded Moses to paint the door-posts of the doors. However, Toaff found another deeper meaning.

Vitale of Weissenburg, Samuele’s agent,

preferred to confer a second meaning upon the rite, that is, that of an upsidedown memorial to the Passion of Christ, considered as an emblem and paradigm of the fall of Israel's enemies and of divine vengeance, forewarning of final redemption. "We use the blood", he declared, "as a sad memorial of Jesus ... in outrage and contempt of Jesus, God of the Christians, and every year we do the memorial of that passion ... in fact, the Jews perform the memorial of the Passion of Christ every year, by mixing the blood of the Christian boy into their unleavened bread.

The evidence is that the Jewish ritual murders continued long after the middle ages. In the 1941 book, *Jewish Ritual-Murder, A Historical Investigation*, Hellmut Schramm, Ph.D., documented over 130 cases of Jewish ritual murder of gentile children between the years 1144 A.D. and 1913 A.D.⁶²⁴ Those cases documented that Jewish doctrine requires the victim to first undergo the most unimaginably sadistic tortures before his blood is drained, in order for the blood to be efficacious.

The Jewish ritual concludes with the victim's blood being drained while the victim's heart is still beating. Dr. Schramm quoted the sworn testimony directly from trial transcripts of the gruesome details of the torture and bleeding of the victims. Dr. Schramm also documented the bribery of the high government officials by rich, powerful Jews in order to undermine investigations and prosecutions of Jewish ritual murderers. The blood, once drained from the victim, is carried away and then later distributed within the Jewish community to be used by Jewish families in the Jewish Passover ceremony.

Is Jewish ritual murder still going on today? Adel Hamood, a reporter for the major Egyptian newspaper, *Al-Ahram*, wrote an article titled, *Jews Make Matzos from the Arab's Blood*

in the October 28, 2000, edition of that newspaper. In that article Hamood revealed that dead Palestinian children have been repeatedly found around Israel, with their blood drained. Hammood stated that “Romania, Germany, Italy, Poland, United States, Egypt, Syria, Portugal, Jordan, France, Russia, Austria, Spain - nearly every civilization in the entire world has reported the crime of Jewish ritual murders. Has the entire world been involved in a massive conspiracy against Jews? Or have some fanatical Jews been engaged in a conspiracy against all non-Jews? Quite frankly, it seems to be the latter.”⁶²⁵

The Zionist Organization of America (ZOA) pressured the Egyptians to retract the aforementioned article or they would see that the United States withheld financial aid to Egypt. Matt Hale states that ZOA President Morton A. Klein wrote to the U.S. Congress: “We urge Congress to refrain from considering the Clinton administration's proposal for \$225 million in extra aid to Egypt until the Mubarak government publicly apologizes and repudiates the blood libel article, and replaces the editor responsible for its publication.”⁶²⁶ That is the typical response of the Jews to any hint in the press of Jewish ritual murder. That is why the world press, for the most part, is silent on this issue. Any editor who allows such an article to be printed will find himself without a job in short order.

On May 1, 1989, Oprah Winfrey interviewed a Jewish woman who revealed her family's involvement in ritual sacrifice of babies. The woman appeared under disguise and used an alias, “Rachel.” The women later publicly came out and revealed that she was Vicki Polin. Polin later revealed that the original agreement with Oprah before her appearance on the show was that Oprah would not mention that she was Jewish. The show was only going to focus on the inter-generational sacrifice of babies, without any mention that she and her family were Jewish. One must ask, why was that such a concern? It seems that it was okay to discuss the sacrifice of babies under the general rubric of

Satanism, but there could be no mention of its link to Judaism.

Polin stated that Oprah let it slip out during the interview that she and her family were Jews, which was contrary to the agreement. What was most telling was that it became clear during the interview that the sacrifice of the babies was part and parcel of her Jewish heritage. That was revealed early in the interview, when Rachel (Vicki Polin) stated that her family had an extensive family tree that goes back to the 1700's, and they keep track of who in the family has been involved in child sacrifice. Her initial point in the interview was that she “was born into a family that believes in this.”⁶²⁷ The family heritage seemed to be very important to the rituals. That was something, however, that Rachel (Vicki Polin) wanted concealed. The chief executives in Oprah Winfrey’s production company are Jews. It is likely that if such an agreement to conceal Rachel’s (Vicki Polin’s) Jewish heritage was not in place, Rachel (Vicki Polin) would likely have never have been allowed to appear on the show. The pertinent part of the interview on Oprah’s show went as follows:

Oprah: “And this is a — does everyone else think it’s a nice Jewish family? From the outside you appear to be a nice Jewish girl.... And you are all worshipping the devil inside the home?”

Rachel: “Right, There’s other Jewish families across the country. It’s not just my own family.”

Oprah: “What Kinds of things went on in the family?”

Rachel: “There would be rituals in which babies would be sacrificed.”

Oprah: “This is the first time I heard of any Jewish people sacrificing babies, but anyway - so you witnessed the sacrifice?”

Rachel: “Right, when I was young, I was forced to participate in that, in which I had to sacrifice an infant.”⁶²⁸

After the airing of that show, Oprah Winfrey was put under tremendous pressure from powerful Jews and Jewish organizations. Kitty Kelley, in her 2010 biography of Oprah Winfrey, revealed that immediately after the show aired, the phones at her production company, Harpo, started jangling with hundreds of irate Jewish callers from all over the country. “Within hours, Jewish groups rose up in condemnation, and Oprah’s show became a national news story.”⁶²⁹ Oprah Winfrey was faced with a financial crisis. No show can appear on television without the approval of the Jewish elite. The chief operating officer at Harpo productions was Jeff Jacobs, who is Jewish. “Recognizing the danger of a national boycott of The Oprah Winfrey Show and the potential loss of sponsors, which could spell financial ruin for everyone, Jacobs quickly offered to meet with Jewish leaders in Chicago to try to salvage the situation.”⁶³⁰ Kitty Kelly explains that Oprah met with Jewish leaders at a meeting arranged by a wealthy Jewish philanthropist, Harriet Brady, to make amends:

Oprah arrived at the meeting on May 9, 1989, with Debar DiMaio and two Jewish members of her senior staff, Jeffrey Jacobs and Ellen Rakieta. They sat down with Michael Kotzin, director of the Jewish Community Relations Council of Metropolitan Chicago; Jonathan Levine, midwest director of the American Jewish Committee; Barry Morrison, director of the Greater Chicago/Wisconsin Regional Office of the Anti-Defamation League of B’nai B’rith;

Rabbi Herman Schaalman, president of the Chicago Board of Rabbis; Maynard Wishner, resident of the Jewish Federation of Metropolitan Chicago; Judge Marovitz; and Mrs. Brady. Oprah was sufficiently contrite and vowed never again to broadcast a show on devil worship. She agreed to reach out to B'nai B'rith, which fights anti-Semitism and racism, whenever her show focused on those subjects, and she promised to exercise better judgment in selecting her guests.⁶³¹

It is notable that part of Oprah's deal for her to head off a sponsor boycott of her show led by the Jewish elite was to "never again broadcast a show on devil worship."⁶³² If the concern was that the show unfairly portrayed Jews, why was the agreement struck with Oprah that she not broadcast any shows whatsoever on devil worship? It seems that the Jewish elite were concerned that any show on devil worship raised the risk that there would be a connection to the Jews. The only way that such a connection could be made is if there is evidence that such a connection exists. It was not just a coincidence that Anton LeVey, who was the founder of the Church of Satan, was a Jew. The reality is that the theology at the core of Judaism is the worship of the devil. The Jewish elite simply could not risk the Jewish correlation being inadvertently discovered during a show on devil worship. They realized that there could be a repeat of the connection between Jews and Satanic ritual murder as already happened on Oprah's show with Rachel. The agreement put in place by Oprah's production team for Rachel's appearance that there be no mention that the practitioners in ritual murder were Jews, was found, in practice, to be an insufficient safeguard. Consequently, Oprah was prohibited thereafter from doing any shows whatsoever on devil worship.

Ritual murder is the dark Satanic secret of Judaism. Jesus alluded to that fact when he told the Jews: "**Ye are of your father**

the devil, and the lusts of your father ye will do. He was a murderer from the beginning, and abode not in the truth, because there is no truth in him. When he speaketh a lie, he speaketh of his own: for he is a liar, and the father of it.” (John 8:44)

The curses pronounced against Christians by the Jews during their Passover ceremony are symptomatic of the orthodox Jewish antipathy of Gentiles in general and hatred of Christians in particular. The most revered rabbis (*gedolim*) view Gentiles as garbage. According to orthodox Judaism, Gentiles are not only an inferior species, but a species that is “completely evil.” For example, Rabbi Saadya Grama of Beth Medrash Govoha in his book *Romemut Yisrael Ufarashat Hagalut* (Jewish Superiority and the Question of Exile) states: “The Jew by his source and in his very essence is entirely good. The *goy* [Gentile], by his source and in his very essence, is completely evil. This is not simply a matter of religious distinction, but rather of two completely different species.”⁶³³

Rabbi Grama is simply stating the philosophy contained in the Talmud. He explains that according to his understanding of Jewish religious doctrine “The difference between Jews and gentiles is not historical or cultural, but rather genetic and unalterable.”⁶³⁴

Rabbi Grama’s opinion cannot be dismissed as a fringe view within orthodox Jewry. His assertion is backed up by other esteemed Rabbis. For example, Rabbi Shneur Zalman, the esteemed founder of *Chabad-Lubavitch*, taught that the difference between Jew and Gentile is not merely religious or racial, but that the souls of Jews and Gentiles are completely different in kind. “Gentile souls are of completely different and inferior order. They are totally evil, with no redeeming qualities whatsoever . . . Indeed they themselves are refuse. . . . All Jews are innately good, all gentiles are innately evil.”⁶³⁵

According to the Talmud, Christians are allied with hell,⁶³⁶ and Jesus is not only cursed,⁶³⁷ he is described as being tormented in boiling hot semen.⁶³⁸ The Talmud, however, gives immunity to rabbis from ever going to hell.⁶³⁹ Chagigah 27a (a/k/a Hagigah 27a) states: “As to disciples of the wise, the flame of Gehenna [hell] has no power over them.”⁶⁴⁰ The Talmud explains in Tractate Baba Bathra that “disciples of the wise men” means scholars or distinguished students.⁶⁴¹ That means that not only are rabbis immune from hell, but also all scholars or distinguished students of the Talmud. Rabbi Shimon ben Yohai declared: “I am beyond the jurisdiction of any angel or judge in heaven.”⁶⁴²

Rabbi ben Yohai, who believed he was beyond the jurisdiction of God, did not think Gentiles were even worthy to live. His views regarding Gentiles were that “even the best of gentiles should all be killed.”⁶⁴³ Rabbi ben Yohai is not a rabbi on the fringes of Judaism; he is in fact one of the most revered of rabbis in Judaism; his grave is a shrine in Israel. He authored the Zohar, which is the principal work of the Kabbalah.

While the Jewish clergy consider Gentiles subhuman, they will turn on Jews who do not adhere to their dictates. Jewish rabbis have nothing but contempt for Jews who do not follow the Jewish traditions.⁶⁴⁴ This overbearing attitude by Jewish rabbis is nothing new. One can sense the contempt that the Pharisees had for the common Jews in John 7:49, where common Jews were impressed by what Jesus had to say, and the Pharisees responded by cursing the Jews for not knowing the “law.” The law to which the Pharisees referred was their oral tradition.

William Wotton explains the undue burdens placed on the Jews through the laws of the Pharisees:

They were absurdly minute in the literal observance of their vows, and as shamefully

subtle in their artful evasion of them. The Pharisees could be easy enough to themselves when convenient, and always as hard and unrelenting as possible to all others. They quibbled and dissolved their oaths with experienced casuistry.⁶⁴⁵

William Wotton (1666-1727) was a rare genius; he undertook foreign language translation at age five, attended Cambridge University at age 10, being graduated at age 13.⁶⁴⁶

The common Jews are as much victims of the Jewish hierarchy as are the Gentiles and Christians. The common Jews are being spiritually brainwashed to do the bidding of their rabbis. Jesus explained the process: “Woe unto you, scribes and Pharisees, hypocrites! for ye compass sea and land to make one proselyte, and when he is made, ye make him twofold more the child of hell than yourselves.” (Matthew 23:15) Jesus cursed the Pharisees and scribes; he could have, but did not, curse all Jews. It is the reprobate spiritual leaders who were the targets of Jesus’ epithets. He came to set Jew and Gentile alike free from spiritual bondage. “Then said Jesus to those Jews which believed on him, If ye continue in my word, then are ye my disciples indeed; And **ye shall know the truth, and the truth shall make you free.**” (John 8:31-32)

According to Orthodox Judaism Gentiles have no property or other rights that can be asserted against a Jew. Baba Bathra 54b: Property of Gentiles is like the desert; whoever gets there first gets it.

Sanhedrin 57a: If a Gentile robs a Jew, he must pay him back; but if a Jew robs a Gentile, the Jew may keep the loot.

With respect to robbery - if one stole or robbed or [seized] a beautiful woman, or [committed]

similar offences, if [these were perpetrated] by one Cuthean against another, [the theft, etc.] must not be kept, and likewise [the theft] of an Israelite by a Cuthean, but that of a Cuthean by an Israelite may be retained.⁶⁴⁷ (brackets in original)

Likewise, if a Gentile kills a Jew, the Gentile is to be killed; but if a Jew kills a Gentile, there is no death penalty. "For murder, whether of a Cuthean by a Cuthean, or of an Israelite by a Cuthean, punishment is incurred; but of a Cuthean by an Israelite, there is no death penalty."⁶⁴⁸ The clear meaning of tractate 57a is that if a Gentile (a/k/a Cuthean or heathen) robs a Jew, he must pay him back. But if a Jew robs a Gentile he may keep the loot. Likewise, if a Gentile kills a Jew, the Gentile is to be killed. But if a Jew kills a Gentile, there is no death penalty.

The clever Jews will deny that the passages in Sanhedrin 57a refer to Gentiles. They will point out that there is no reference to Gentiles in those passages; that the passages refer only to "Cutheans." If you read footnote 33 to Sanhedrin 57a you will find that the editors placed a guide to the Jews for their understanding of the terms used. It states that the word "Cuthean" is a reference to Gentiles. Footnote 33 states: "'Cuthean' (Samaritan) was here substituted by the censor for the original goy (heathen)." The text was revised by a censor. The job of the censor was to obfuscate certain passages, so that Gentiles reading the Talmud would have a difficult time discerning the attack upon them. Inserting the word "Cuthean" in place of "goy" is one example of that obfuscation. Often the word "heathen" was substituted for Gentile or goyim in the Talmud by the censor.

In the Talmud the words *goi*, *goy*, and *goyim* (pejorative for gentiles) were replaced with "Kushite" or "Kuthite" in the 1578 Basel edition of the Talmud.⁶⁴⁹ "Heathen" is often substituted for *Goy* or Gentile in the Talmud. *Min* and *minim* (pejorative for Christians) were replaced with words like

“Sadducee” or “Epicurean.”⁶⁵⁰ Other words used in place of Christians are “idol worshiper,” “Akum,” and “Cuthean.”⁶⁵¹ The curses and blasphemy against Jesus are concealed by replacing Jesus’ name with Balaam and other pseudonyms. Jewish Professor Israel Shahak explains that the offensive passages in the Talmud with the new terms could be explained away to the gullible Gentiles, but the Jewish reader could easily recognize the new euphemism for the old expressions.⁶⁵²

The redacted Talmud is trotted out by rabbis to prove that there are no imprecations against Jesus and no admonitions to steal from or kill gentiles. The rabbis keep secret the fact that the language in the publically available Talmud has been changed to conceal the offense of the original text.

The censored texts were secretly recorded and preserved by the Jews. They then clandestinely reproduced the uncensored text in a supplement known as the *Hesront Ha-shas*. “Anyone who possessed the Catholic-authorized expurgated Talmud and the *Hesront Ha-shas* possessed the complete Talmud - an ingenious joke on Christians and quite a coup by the Vatican Mafia on behalf of its rabbinic partners in the conspiracy against the gospel of Jesus Christ.”⁶⁵³

An example of the obfuscation of offensive passages is Sanhedrin 106b, which says this about Jesus (pseudonym Balaam⁶⁵⁴):

A certain min said to R. Hanina: Hast thou heard how old Balaam was? — He replied: It is not actually stated, but since it is written, Bloody and deceitful men shall not live out half their days, it follows that he was thirty-three or thirty-four years old. He rejoined: Thou hast said correctly; I personally have seen Balaam's Chronicle, in which it is stated, 'Balaam the lame was thirty

years old when Phinehas the Robber killed him.”⁶⁵⁵

This cryptic verse in Sanhedrin 106b conceals that fact that the “bloody and deceitful” man referred to is Jesus. In the Talmud, Balaam is used as a code for Jesus. A footnote to the passage explains that Phinehas the Robber is a coded pseudonym for Pontius Pilate and “Balaam’s Chronicle” means “a Gospel.”⁶⁵⁶

Elizabeth Dilling in her well researched book, *The Jewish Religion, Its Influence Today*, explains that Balaam is a pseudonym used in place of Jesus. She explains that “[p]roof that Jesus is called ‘Balaam’ is found in the Jewish Encyclopedia (under “Balaam”) which, after enumerating His alleged loathsome qualities, states: ‘Hence ... the pseudonym ‘Balaam’ given to Jesus in Sanhedrin 106b and Gittin 57a.’”⁶⁵⁷

The Jewish Encyclopedia is authoritative. It presents a long list of eminent scholars who are experts in Judaism that contributed to the encyclopedia entry on Balaam, and who no doubt took great care in accurately explaining the meaning and use of “Balaam.”⁶⁵⁸ The entry for Jesus in the Jewish Encyclopedia confirms that Balaam in the Talmud is a pseudonym for Jesus: “As Balaam the magician and, according to the derivation of his name, ‘destroyer of the people’, was from both of these points of view a good prototype of Jesus, the latter was also called ‘Balaam.’”⁶⁵⁹

Jewish censors redacted and obfuscated the Talmud, in part, because Jews are very concerned about Gentiles discovering their hidden hatred toward Gentiles. It is for that reason that Jews are forbidden to share with gentiles their religious doctrines. “To communicate anything to a goy about our religious relations would be equal to the killing of all the Jews, for if the goys knew what we teach about them, they would kill us openly.” (Book of Libbre David, 37)⁶⁶⁰ “Every goy who studies Talmud, and every Jew who helps him in it, ought to die.” (Sanhedryn 59 a. Aboda Zora

8-6. Szagiga 13.)⁶⁶¹

Gemara at Sahendrin Tractate 52b provides that adultery is forbidden with the neighbor's wife, but is not forbidden with the wife of a heathen (Gentile). The implication is that a Gentile is not a neighbor.

Our Rabbis taught: [And the man that committeth adultery with another man's wife, even he that committeth adultery with his neighbour's wife the adulterer and the adulteress shall surely be put to death]. 'The man' excludes a minor; 'that committeth adultery with another man's wife' excludes the wife of a minor; 'even he that committeth adultery with his neighbour's wife' excludes the wife of a heathen; 'shall surely be put to death', by strangulation.⁶⁶² (brackets in original).

Sanhedrin 100b states: Those sent to hell include “he who reads uncanonical books etc. A Tanna taught: this means, the books of the Sadducees.” It would seem that the uncanonical books are books of the Sadducees, but that is coded language inserted by censors to conceal the fact that the “uncanonical books” actually refers to the New Testament. A footnote immediately after the words “books of the Sadducees” states:

This probably refers to the works of the Judeo-Christians, i.e., the **New Testament**. There were no Sadducees after the destruction of the Temple, and so '**Sadducees**' is **probably a censor's emendation for sectarians or Gentiles** (Herford, Christianity in the Talmud, p. 333.) [MS.M. reads, Minim.]⁶⁶³ (emphasis added)

Talmudic Judaism has the most intense hatred for Jesus.⁶⁶⁴

While some Jews will deny that the Talmud teaches such things, Benjamin Freedman, a former Talmudic Jew, stated that: “there have never been recorded more vicious and vile libelous blasphemies of Jesus, of Christians and the Christian faith than you will find between the covers of the 63 books of the Talmud, which forms the basis of Jewish religious law, as well as being the textbook used in the training of rabbis.”⁶⁶⁵ For example:

Shabbath 104b: Jesus was a magician and a fool. Mary was an adulteress.

Sanhedrin 106a also calls Jesus a soothsayer, and his mother, Mary, a harlot:

Balaam also the son of Beor, **the soothsayer**, did the children of Israel slay with the sword. A soothsayer? But he was a prophet! — R. Johanan said: At first he was a prophet, but subsequently a soothsayer. R. Papa observed: This is what men say, 'She who was the descendant of princes and governors, **played the harlot** with carpenters.'⁶⁶⁶

A footnote to the Sanhedrin 106a passage explains that Balaam in that passage refers to Jesus and she who played the harlot with carpenters alludes to Mary, the mother of Jesus. That footnote states:

Herford, Christianity in the Talmud, p. 48, suggests that **Balaam is frequently used in the Talmud as a type for Jesus** (v. also pp. 64-70). Though no name is mentioned to shew which woman is meant, the mother of Jesus may be alluded to, which theory is strengthened by the statement that she mated with a carpenter.⁶⁶⁷

Sanhedrin 43a: Jesus was guilty of sorcery and apostasy, he deserved execution. The disciples of Jesus deserve to be killed.

Gittin 57a: Jesus was sent to hell, where he is punished in boiling hot semen for mocking the Rabbis.

He then went and raised **Balaam** by incantations. ... He then asked: What is your punishment? He replied: With boiling hot semen. He then went and raised by incantations the **sinners of Israel**. He asked them: Who is in repute in the other world? They replied: Israel. What about joining them? They replied: Seek their welfare, seek not their harm. Whoever touches them touches the apple of his eye. He said: What is your punishment? They replied: With boiling hot excrement, since a Master has said: Whoever mocks at the words of the Sages is punished with boiling hot excrement.⁶⁶⁸ (emphasis added)

We know that passage in Gittin 57a refers to Jesus, because the Jewish Encyclopedia states that Balaam is a pseudonym for Jesus in Gittin 57a.⁶⁶⁹ Furthermore, the passage has a footnote appended to “sinners of Israel” that states: “MS.M. Jesus,”⁶⁷⁰ which means that “sinners of Israel” is a pseudonym for Jesus.

The above racial hatred toward Gentiles, Jesus, and Christians by the Jews contained in the Jewish Talmud is hard for some to believe. It is so brazenly hateful that some may doubt the accuracy of the above quotations from the Talmud. The above quotations were taken directly from the Jews' College English translation of the Talmud, which was published through Soncino Press between 1935 and 1948. It was produced by the most learned Judaic scholars at the time and is recognized worldwide as the authoritative English translation of the Talmud. It is of

unquestionable accuracy and authority, which is fully revealed once one is aware of the redaction and obfuscation from the Jewish censors explained above.

The Soncino Press has a long history of accurate printing of the Talmud, going back for centuries. The Soncino website states:

The seal of the Soncino Press and the name it represents date back half a millennium. The most famous of the first Jewish printers, the Soncino family hailed from the Alsatian town of Speyer and settled in Soncino, a village in northern Italy from which they took their name. Joshua Soncino set up one of the world's first Hebrew printing presses in 1484, on which he printed Soncino's first Hebrew book, the Talmud tractate Berakoth. He also produced the first printed Hebrew Bible complete with vowels--no mean feat for the early, primitive days of printing.⁶⁷¹

The late Dr. Joseph Herman Hertz, The Chief Rabbi of the British Empire at the time the Soncino Talmud was first published, wrote forewords for four of the six seders. He praised the Soncino Talmud with these words:

A reliable English translation of the whole Babylonian Talmud has long been looked forward to by scholars. This expectation is beginning to be realised by the publication of the Soncino edition of the Order Nezikin. ...

This notable achievement is due to the quite extraordinary erudition of the Editor, Rabbi Dr I. Epstein, assisted by his staff of scholarly translators. The Editor's Prefatory Note gives

some indication of his colossal task. Aside from planning the scope and character of the work, the Editor Fixed the Text, controlled the translation and interpretation, as well as the introductions and glossaries to the various parts, and supplied the greater portion of the 'cultural' notes.

The Publishers too have done their share in the undertaking conscientiously and efficiently. With the result, that never before has there appeared a translation of the Order Nezikin as helpful to the student as these volumes of the Soncino edition of the Babylonian Talmud in English. ...

The eight volumes of Seder Nashim have been planned on the same lines as those of Seder Nezikin, alike in regard to Text, rendering and cultural Notes. The Editor and his collaborators have again performed with consummate skill a task of stupendous difficulty, and the standard of scholarship and accuracy set in the previous volumes has been fully maintained. The Publishers also have left nothing undone to render the Soncino Seder Nashim in every way a worthy continuation of their Seder Nezikin.

The following accolades are printed on the dust jacket of the 1961 Edition of the Soncino Talmud:

[T]his translation of the Talmud will open up for the English speaking readers the most varied and indispensable index to the collective wisdom of the post-Biblical Hebrew mind, and afford direct knowledge of the ordinances which have governed and continue to govern the religious institutions and social polity of the Jewish

people. - *The late Rabbi Dr. A. Feldman, Dayan of the Beth Din, London.*

I offer my heartiest congratulations to all who have worked together in producing this translation of the Talmud into English. They have dealt with the enormous difficulties of their tasks with remarkable skill. - *The Rev. Dr. R. Travers Herford, author of Christianity in Talmud and Midrash and Talmud and Apocrypha.*

The Editor, Dr. Isidore Epstein, and his band of scholars have produced a translation which is a marvel of skill in dealing with the formidable difficulties which the Talmud presents. - *The Jewish Chronicle.*

The Soncino Talmud is ... an adornment for any library, a hallmark of intelligent Jewishness in a family ... an unfailing source of inspiring information to the students of every creed and race. - *Jewish Forum.*

It [the Soncino Talmud] will have value for Gentile as well as Jewish scholars. - *The Manchester Guardian.*

These volumes are magnificently produced, and will assuredly take their place among the monuments of modern scholarship. - *The Yorkshire Post.*

The rendering is accurate and scholarly ... In particular the translators deserve praise for their choice of suitable equivalents for technical terms and phrases that are difficult to turn into another

language. - *The Times Literary Supplement*.

Michael Hoffman explains that “[l]ike the Talmud, the Kabbalah supersedes, nullifies and ultimately replaces the Bible.”⁶⁷² Lawrence Fine, Professor of Jewish Studies and prominent scholar of medieval Judaism and Jewish mysticism, reveals that the Kabbalah contains the “true” meaning of the Old Testament. The “simple” meaning of the biblical language recedes into the background as the symbolic meaning contained in the Kabbalah supercedes the bible and takes control. There is a code to the true meaning in the bible that can only be unlocked through the Kabbalah.

[T]he reader must become accustomed to regarding biblical language in a kabbalistically symbolic way. The Kabbalists taught that the Torah is not only the speech or word of God, but is also the many names of God or expression of God’s being. It is a vast body of symbols, which refers to the various aspects of divine life, the sefirot, and their complex interaction. **The simple meaning of biblical language recedes into the background as symbolic discourse assumes control.** The true meaning of Scripture becomes manifest only when it is read with the proper (sefirotic) code. **Thus the Torah must not be read on the simple or obvious level of meaning; it must be read with the knowledge of a kabbalist who possesses the hermeneutical keys with which to unlock its *inner* truths.**⁶⁷³

The Kabbalah at Zohar III, 152a states: “Thus the tales related to the Torah are simply her outer garments, and woe to the person who regards that outer garb as the Torah itself! For such a person will be deprived of a portion in the world to come.”⁶⁷⁴ That passage in the Kabbalah puts a curse on anyone who tries to

read the bible for what it actually says, instead of with the mystical gloss put on it by the Kabbalah.

The Kabbalah is Judaic mystical practices that were adopted by the Jews from Babylon. H.P. Blavatsky described the Kabbalah as:

The hidden wisdom of the Hebrew Rabbis of the middle ages derived from the older secret doctrines concerning divine things and cosmogony, which were combined into a theology after the time of the captivity of the Jews in Babylon. All the works that fall under the esoteric category are termed Kabalistic.⁶⁷⁵

Magic and occult mysticism run throughout the Kabbalah. Judith Weill, a professor of Jewish mysticism stated that magic is deeply rooted in Jewish tradition, but the Jews are reticent to acknowledge it and don't even refer to it as magic.⁶⁷⁶

Gershom Scholem (1897-1982), Professor of Kabbalah at Hebrew University in Jerusalem, admitted that the Kabbalah contains a great deal of black magic and sorcery, which he explained involves invoking the powers of devils to disrupt the natural order of things.⁶⁷⁷ Professor Scholem also stated that there are devils who are in submission to the Talmud; in the Kabbalah these devils are called *shedim Yehuda'im*.⁶⁷⁸

The *Jewish Chronicle* revealed that occult practices such as making amulets, charms, and talismans are taught in Jerusalem at the rabbinic seminary Yeshivat Hamekubalim.⁶⁷⁹ That is why Jesus said to the Jews: "Ye are of your father the devil, and the lusts of your father ye will do." John 8:44. The bible states clearly that the magic arts are an abomination to the Lord.

There shall not be found among you any one that

maketh his son or his daughter to pass through the fire, or that useth divination, or an observer of times, or an enchanter, or a witch, Or a charmer, or a consulter with familiar spirits, or a wizard, or a necromancer. For all that do these things are an abomination unto the LORD: and because of these abominations the LORD thy God doth drive them out from before thee. (Deuteronomy 18:10-12)

 pdfelement

28

Mind Control

Zionist Jews control the educational system, and have created a false science that has removed God from the minds of men through so-called science that alleges that there is a universe without a creator. This atheistic education undermines Christian morals and order. It is all happening according to plan. Once the Zionists are in position of rule over the world, they will teach nothing but submission to their authority. Paragraph three of Protocol 16 of the Protocols of the Learned Elders of Zion states:

We must introduce into their education all those principles which have so brilliantly broken up their order. But when we are in power we shall remove every kind of disturbing subject from the course of education and shall make out of the youth obedient children of authority, loving him who rules as the support and hope of peace and quiet.⁶⁸⁰

It is indispensable to the Zionists' plans for world domination to undermine all religion. That is why they need to control the education of our children. That is where they instill the first ideas of atheism through the theories of evolution and

heliocentricity. Paragraph three of Protocol 4 states.

It is indispensable for us to undermine all faith, to tear out of the mind of the "goyim" the very principle of god-head and the spirit, and to put in its place arithmetical calculations and material needs.⁶⁸¹

Heliocentrism, which theorizes that the earth orbits the sun as it also spins, is the seminal scientific theory from which all scientific deception flows. Heliocentrism is not based upon science; it is based upon religious superstition. So-called scientists have concluded that the earth orbits the sun. Nicolaus Copernicus died in 1543 on the day his book, *On the Revolutions of the Celestial Spheres*, was published. Most people do not know that Copernicus did not originate the theory that the earth revolves around the sun. Aristarchus of Samos (310 – 230 B. C.) postulated that the earth rotates on an axis daily and orbits the sun annually. Pythagoras (circa 500 B.C.) had a similar model of planets (which purportedly included the sun) orbiting around a central, invisible fire. Both Pythagoras' and Aristarchus' models had generally been rejected, until Copernicus' book was published. There was initially strong resistance to Copernicus' heliocentric system. However, over time the heliocentric view, with the earth and the other planets rotating around sun, has won popular acceptance.

The heliocentric theory removed the earth as the center of creation and challenged the entire ancient authority of the Bible regarding the universe and its origins. Heliocentricity is the progenitor of the theory of evolution.

Tycho Brahe (1546 – 1601), was born three years after Copernicus died. His observations and models established that the earth is stationary. Scientists have through objective experiments confirmed Brahe's findings regarding a stationary earth.

You would think that all of this spinning, ~~orbiting, and~~ hurtling through space is something that has been detected and measured by the “scientists” who promote that notion. In fact, all true scientific efforts to measure that movement has only proven that the earth is stationary and does not move.

Elite Jews are the agents of Satan in a massive conspiracy working toward world domination. In order to control people, these arch-criminals must remove from the consciences of the people any knowledge of God. Satan and his minions have a problem, and that is found in God’s creation, which everyone can see around them. God’s creation reveals God to everyone day and night.

The heavens declare the glory of God; and the firmament sheweth his handywork. Day unto day uttereth speech, and night unto night sheweth knowledge. There is no speech nor language, where their voice is not heard. Their line is gone out through all the earth, and their words to the end of the world. In them hath he set a tabernacle for the sun, Which is as a bridegroom coming out of his chamber, and rejoiceth as a strong man to run a race. His going forth is from the end of the heaven, and his circuit unto the ends of it: and there is nothing hid from the heat thereof.”
(Psalms 19:1-6)

In Psalms 19:1-6, God reveals that the heavens declare his glory and the firmament shows his handiwork. All one need do is look up and God is revealed by his heavenly creation. Indeed, God testifies that the sun travels in a circuit. Anyone looking up can see this happening each day. Satan had to figure out a way to deceive people into rejecting what God’s creation was revealing. Satan did this through convincing people that what they are seeing is a very distant sun and the earth is spinning on an axis while it rotates

around that sun. He has convinced the world that the sun does not move in a circuit as the bible states, but rather, it is the earth that is moving. How could Satan get people to ignore what they could see with their own eyes? George Orwell provides an answer.

George Orwell was a disillusioned communist insider who exposed the methods and aims of the world ruling elite in the form of a dystopian novel titled *1984*. In his book, a conversation takes place between O'Brien, a powerful member of the Inner Party, which is the elite ruling minority, and the protagonist, Winston Smith. The conversation takes place while O'Brien is in the midst of torturing Winston. O'Brien tells Winston:

The Party seeks power entirely for its own sake. We are not interested in the good of others; we are interested solely in power. Not wealth or luxury or long life or happiness: only power, pure power. ... We know that no one ever seizes power with the intention of relinquishing it. Power is not a means, it is an end. One does not establish a dictatorship in order to safeguard a revolution; one makes the revolution in order to establish the dictatorship. The object of persecution is persecution. The object of torture is torture. The object of power is power. Now do you begin to understand me? ...

We are the priests of power ... God is power. But at present power is only a word so far as you are concerned. It is time for you to gather some idea of what power means. The first thing you must realize is that power is collective. The individual only has power in so far as he ceases to be an individual. You know the Party slogan: "Freedom is Slavery". Has it ever occurred to you that it is reversible? Slavery is freedom. Alone — free —

the human being is always defeated. It must be so, because every human being is doomed to die, which is the greatest of all failures. But if he can make complete, utter submission, if he can escape from his identity, if he can merge himself in the Party so that he IS the Party, then he is all-powerful and immortal. **The second thing for you to realize is that power is power over human beings. Over the body — but, above all, over the mind. Power over matter — external reality, as you would call it — is not important. Already our control over matter is absolute.**⁶⁸²

At that point, Winston challenged O'Brien. Winston stated that the party could not control matter, because they cannot control climate or prevent diseases. It was at that point that O'Brien explained: **"We control matter because we control the mind."**⁶⁸³

Winston and O'Brien continued their conversation, and during the discussion Winston exclaimed to O'Brien: "But the whole universe is outside us. Look at the stars! Some of them are a million light-years away. They are out of our reach for ever."

O'Brien rebutted Winston's declaration, by explaining:

'What are the stars?' said O'Brien indifferently. 'They are bits of fire a few kilometres away. We could reach them if we wanted to. Or we could blot them out. The earth is the centre of the universe. The sun and the stars go round it.'

Winston made another convulsive movement. This time he did not say anything. O'Brien continued as though answering a spoken

objection:

‘For certain purposes, of course, that is not true. When we navigate the ocean, or when we predict an eclipse, we often find it convenient to assume that the earth goes round the sun and that the stars are millions upon millions of kilometres away. But what of it? Do you suppose it is beyond us to produce a dual system of astronomy? The stars can be near or distant, according as we need them. Do you suppose our mathematicians are unequal to that? Have you forgotten doublethink?’⁶⁸⁴

Notice that Orwell reveals in his book that heliocentrism is central to the deception of “doublethink.” In Orwell’s *1984*, Orwell explains that doublethink is to deny the existence of objective reality, while at the same time accepting the reality that is denied. Orwell explained that doublethink is “to be conscious of complete truthfulness while telling carefully constructed lies.”⁶⁸⁵

Under the rubric of doublethink, scientists at the highest level accept that the earth is flat, yet they deny that known reality, because pressure has been put upon them to “fit in,” to gain status within their profession. If someone even so much as mentions any contradiction of the orthodox view of heliocentricity, he is subject to ridicule and loses his status as a respected “scientist.” There are strategically placed gatekeepers, who ensure that the truth does not come out. Deviation from the “party line” is akin to blasphemy, which subjects the blasphemer to instant social and professional disapproval and punishment. Research grants to the blasphemer would instantly dry up. The scientific heretic would lose his professorship and be brought to economic and professional ruin to reveal what he knows to be the truth. In order to get along, scientists go along with doublethink. Otherwise, they would be crushed.

O'Brien identifies the deceivers in the ~~doublethink~~ heliocentric myth. O'Brien reveals that it is "mathematicians" who are at the center of the heliocentric deception. As we have seen, mathematics has been used to replace experimental physicists to construct the doublethink new "reality" of relativity. Astrophysicists are not really physicists; they are lying mathematicians, who have created a mythology using mathematic models. The reality is that no astrophysicist has ever been to the place to where they claim to be experts. The reason is simple, there is no such thing as outer space. These mathematicians, masquerading as astrophysicist, simply bedazzle the uninformed with bizarre equations they use to support the deception of heliocentrism. Astrophysicists are akin to priests in an occult religion. Just as the witch-doctor is held in awe by the ignorant tribe for his superstitious knowledge, so also is the astrophysicist held in awe for his so-called "scientific" knowledge. In both cases their esteem is born of spiritual deception.

Doublethink is indispensable to the mind control of the ruling elite. Orwell explains in *1984*:

To tell deliberate lies while genuinely believing in them, to forget any fact that has become inconvenient, and then, when it becomes necessary again, to draw it back from oblivion for just so long as it is needed, to deny the existence of objective reality and all the while to take account of the reality which one denies — all this is indispensably necessary. Even in using the word DOUBLETHINK it is necessary to exercise DOUBLETHINK. For by using the word one admits that one is tampering with reality; by a fresh act of DOUBLETHINK one erases this knowledge; and so on indefinitely, with the lie always one leap ahead of the truth. Ultimately it is by means of DOUBLETHINK that the Party

has been able — and may, for all we know, continue to be able for thousands of years — to arrest the course of history.⁶⁸⁶

Understand what Orwell is revealing. The ruling elite have complete control over all elements of society, because they control what people think. They do not actually control matter; all they need do is convince that population to believe what is false about matter and they thus control matter in that sense. It is the ultimate in mind control to get people to believe a lie is truth. Indeed, the slogan of the Party in *1984* is that “Freedom is Slavery.”

The Jewish elite do not have the power to make the earth spin at approximately 1,000 miles per hour at the equator, while at the same time orbiting the sun at approximately 67,000 miles per hour. All they need to do is convince the population of the world that is what happens. That is what O’Brien meant when he stated that “we control matter because we control the mind.”

Why would the Jewish elite want to deceive the world about the nature of our world? Eric Dubay, author of *The Flat Earth Conspiracy*, offers this explanation:

Our eyes and ears tell us the Earth is flat and motionless, everything in the sky revolves around us, but when we cease to believe our own eyes and experience, we have to prostrate ourselves at the feet of the very pseudo scientists who are blinding us, treat them as experts, astronomical priests, who have special knowledge only they can access like the Hubble telescope.

So by brainwashing us of something so gigantic and fundamental it actually makes every other kind of lesser indoctrination a piece a cake. Earth being the flat earth center of

the universe, of which everything else and the heavens revolve, gives special importance and significance not only to earth but to us humans, the most intelligent of the designers design.

By turning earth into a spinning ball, thrown around the Sun, shot into infinite space from a God-less big bang, they turned humanity into a random meaningless, purposeless accident of a blind dumb universe. So it's like trauma based mind control ... So this modern atheistic, Big Bang, heliocentric globe earth, chance evolution, paradigm spiritually controls humanity by removing God or any sort of intelligent design from the mind and replaces purposeful divine creation with haphazard random cosmic coincidence.

And so by removing Earth from the motionless center of the universe these Masons have moved us physically and metaphysically from a place of supreme importance to one of complete nihilistic indifference.

If the Earth is the center of the Universe then the ideas of God creation and a purpose for human existence are resplendent, but if the Earth is just one of billions of planets revolving around billions of stars and billions of galaxies then the ideas of God creations and a specific purpose for Earth and human existence become highly implausible.

By surreptitiously indoctrinating us into their scientific materialist sun worship, not only do we lose faith beyond the material, we gain absolute

faith in materiality, superficiality, social status, selfishness, hedonism and consumerism.

If there is no God and everyone is just an accident then all that matters is me, me, me. ... Their rich powerful corporations with their slick sun cult logos sell us idols to worship, slowly taking over the world, while we tacitly believe their science, vote for their politicians, buy their products, listen to their music, watch their movies, all sacrificing our souls to the altar of materialism.

It's a big deception!⁶⁸⁷

Dubay makes the point that “this is basically the biggest thing you could possibly lie about, so the psychopaths that control society are interested in world domination; the best way to brainwash the whole world is to lie to the whole world about what the world is.”⁶⁸⁸ The New World Order is based upon disinformation, and Heliocentrism is its keystone deception.

Indeed, the governments of the world rule upon the principle of disinformation. This is illustrated by an episode that took place in 1983, when New Hampshire Governor Meldrim Thomson Jr. wrote to President Ronald Reagan objecting to the planned national holiday for Martin Luther King Jr. Thomson pointed out the evidence of King's “immoral character” and his affiliation with communists. Ronald Reagan's response to Thomson gives insight into the effect of disinformation on the masses and how it frames the laws and policies of government. On October 3, 1983, President Reagan responded to Thomson: “On the national holiday you mentioned, I have the reservations you have, but here the perception of too many people is based on an image, not reality. Indeed to them, the perception is reality.”⁶⁸⁹

It did not matter to Reagan what the truth was, it was the perception that was important when it came to making political decisions. The masses of people had been deceived into believing that Martin Luther King Jr. was a selfless champion of civil rights for all. The truth that King was a tool of the communists to push for special government granted group privileges as a means to supplant individual God-given rights was known only by a few.

Because of the effectiveness of the disinformation campaign that propped up Martin Luther King Jr. as a paragon of virtue, the government was in the clear in acting to honor a plagiarizing, womanizing, communist shill.⁶⁹⁰ Ralph Abernathy, who King called “the best friend I have in the world,” documented in his autobiography, *And the Walls Came Tumbling Down*, that Martin Luther King Jr. was an immoral charlatan. King was a wolf in sheep’s clothing. Dr. Jimmy T. (Gunny) LaBaume reveals that Martin Luther King Jr. was a heathen who was playing the role of a Christian minister.

King, the charismatic speaker, does not seem to be the committed Christian he professed to be. In fact, he said that the Bible was filled with “legends and myths” and denied that Christ was physically raised from the dead. As a seminary student King was not at all enthusiastic about Christianity. Carl Rowan wrote in *Reader’s Digest* (September 1967) that “the thinking of Gandhi and Thoreau was ... burning inside King”⁶⁹¹

The King family is in on the charade. King’s wife, Coretta Scott King, knowing full well that her husband was a charlatan, marched into federal court, and on Jan. 31, 1977, “obtained a federal court order sealing 845 pages of FBI records about her husband for 50 years, ‘because its release would destroy his reputation!’ This federal judge sealed the files until the year

2027.”⁶⁹² Indeed, many of the sealed documents have been characterized as “obscene.” Most of Martin Luther King Jr.’s Boston University doctoral dissertation has been proven to be plagiarized. Plagiarization seems to have been a family value in the King household. Coretta Scott King, who acted as Martin Luther King’s secretary at the time Martin Luther King Jr. put together his dissertation, was an accomplice in the plagiarization. Dr. LaBaume reveals that Martin Luther King Jr. simply could not help himself. King was a serial plagiarizer.

[O]ver his life, most of his papers, speeches, and ‘sermons’ were copied word for word from Dr. Jack Boozer, Edgar S. Brightman, and Paul Tillich. As a matter of fact, he lifted whole sections of his famous “I Have a Dream” speech from a sermon by Archibald Carey, a popular black preacher in the 1950’s.⁶⁹³

Martin Luther King Jr. routinely embezzled Southern Leadership Conference (SLC) money to pay for prostitutes. King was a moral degenerate, whose role was to implement the tried and true communist method of secretly agitating violence, while at the same time preaching non-violence. He thus appeared to be the victim of the very violence he planned ahead of time. Martin Luther King Jr. was a communist revolutionary. According to King's biographer and sympathizer David J. Garrow, “King privately described himself as a Marxist.”⁶⁹⁴ In his 1981 book, *The FBI and Martin Luther King, Jr.*, Garrow quotes King as saying in SCLC staff meetings, “we have moved into a new era, which must be an era of revolution.... The whole structure of American life must be changed.... We are engaged in the class struggle.”⁶⁹⁵ Dr. Don Boys, who is a former member of the Indiana House of Representatives and has authored 15 books, explains that “those words [of King] are right out the Communist handbook.”⁶⁹⁶ Dr. Boys further states: “Need I remind you that it was illegal to be a Communist in those days? The Communist Party was dedicated to

overthrow our Constitution and way of life.”⁶⁹⁷ Dr. Boys reveals little known inside information from Uriah Fields, who was Martin Luther King Jr.’s secretary early on in King’s communist agitation.

The Rev. Uriah J. Fields, King's secretary during the early stage of the Montgomery Bus Boycott, wrote in the March 1968 issue of *American Challenger*: "King helps to advance Communism. He is surrounded with communists. This is a major reason why I severed my relationship with him during the fifties. He is soft on Communism. I don't believe that he is a Communist or a Christian, for that matter." There is no doubt that King was not a Christian, and he was not a "card-carrying" Communist because Communists stopped carrying cards many years before that time. The question is not whether King belonged to the Communist Party, U.S.A. but was he a Communist?⁶⁹⁸

The circumstantial evidence certainly suggests that Martin Luther King Jr. was a communist. Jewish Communist Stanley Levison can best be described as King's behind-the-scenes "handler." Levison had for years been in charge of the secret Soviet funding of the Communist Party, USA. Levison was King's mentor and was actually the brains behind King. It was Levison who edited King's book, *Stride Toward Freedom*.⁶⁹⁹ Levison controlled the fund-raising and agitation activities of the SCLC from behind the scenes. Levison wrote many of King's speeches. King described Levison as one of his "closest friends."⁷⁰⁰

Dr Boys further reveals that Julia Brown, who worked undercover in the communist party on behalf of the FBI, testified before the U.S. Congress about Martin Luther King Jr.’s communist ties.

While King may not have been an official member of the Communist Party, he was certainly supported by them because he supported their cause! Julia Brown was an undercover agent for the FBI in the Cleveland, Ohio area. She told a Congressional sub-committee that while she was a member of the Communist Party, "she knew Martin Luther King to be closely connected with the Communist Party." On the lecture circuit, she told audiences that King "was the hero of America's Communists. The cells that I was associated with in Cleveland were continually being asked to raise funds for Martin Luther King's activities." She also said, "Mr. King was one of the worst enemies my people ever had." Oh, by the way, Julia was black! How about a holiday for a real black hero? In June of 1979 she testified at a Senate Judiciary Committee and concluded her statement to the Committee: "If this measure is passed honoring Martin Luther King, we may as well take down the stars and stripes that flies over this building and replace it with a red flag."⁷⁰¹

Despite Brown's testimony, Congress nonetheless voted to approve the national holiday for Martin Luther King Jr. four years later. Reagan signed the bill into law. Reagan knew all of the above information about Martin Luther King Jr., and even more, but he did not care. He was in on the game. He, like Martin Luther King Jr., was also a charlatan. He was a socialist actor simply playing the role of a conservative politician. The statement of George H. W. Bush to Sarah McLendon could as easily have applied to Ronald Reagan. Bush told Sarah McLendon in 1992: "Sarah, if the American people ever find out what we have done, they would chase us down the street and lynch us."

A conquering force, upon taking control of a country, will always change the national landmarks. Such changes in national landmarks are also a sign of a covert political takeover. One of the first things that communists do when taking over a country is to rewrite the history of the nation so that the people are left

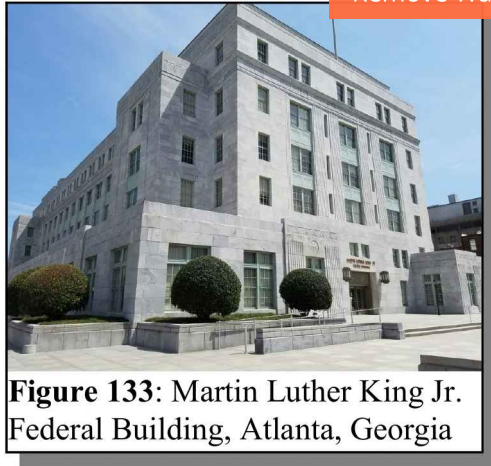

Figure 133: Martin Luther King Jr. Federal Building, Atlanta, Georgia

without a national heritage. In accomplishing that, national heroes are excised from the history books, or their patriotic deeds are distorted to fit communist ideology. The communists then elevate its killers and criminals as the new heroes.⁷⁰² These new communist heroes are then celebrated with monuments and national holidays. That is what has been done in the case of Martin Luther King Jr.⁷⁰³ He is a communist saint who is idolized in the United States with a national holiday. Streets, schools, and federal buildings all over the country have been named in his honor. Indeed, much to the confusion of the local citizens, many long established streets have been renamed in honor of Martin Luther King Jr.

While the Martin Luther King Jr. national holiday is largely symbolic, its symbolism acts to reinforce in the minds of the general population the need for the government to pass laws and use its force to grant privileges to a favored group. The result of the new laws is an erosion of the individual liberties of all. It is this method that has given rise to the government privilege of women to kill their children through abortion to supplant the unborn child's God-given right to life. It can also be seen with the special government privileges granted to sodomites. Those special

group privileges of the sodomites will be used as a lever to supplant that God-given individual rights of Christians.

One recent example of using government privileges to trample the God-given rights of the American people is the case of a Christian couple, Aaron and Melissa Klein mentioned in this book's introduction. As you recall, the Kleins were forced to shut down their bakery after they were ordered to pay \$135,000 in damages by the Oregon Bureau of Labor and Industry (BOLI) for refusing to bake a cake for a lesbian wedding because of their sincerely held religious belief that sodomy is a sin.⁷⁰⁴ Todd Starnes of Fox News and Commentary explains that "the Klein case has demonstrated once again that gay rights trump religious liberty. Other Christian business owners should pay close attention. The Kleins had a choice. They could obey the government or they could obey God. They chose God – and now they must pay the price."⁷⁰⁵

The Klein case is the sour fruit of the civil rights tree planted by the communist handlers of Martin Luther King Jr. It is only the beginning. The civil rights laws that are now being used to trample God-given rights could not have been passed without the disinformation that was part and parcel of the civil rights movement.

Barbara Honegger, who was Assistant to the Chief Domestic Policy Adviser to the President, was present at a cabinet meeting during the first weeks (February 1981) of the Reagan Administration in the Roosevelt Room in the West Wing of the White House when CIA Director William Casey stated: "We'll know our disinformation program is a success when everything the American public believes is false."⁷⁰⁶ Honegger reported the statement to her close friend Senior White House correspondent Sarah McClendon, who in turn made it public without naming Honegger as the source.

In or about 2013, people posted on the internet their skepticism of the authenticity of the Casey quote. On November 25, 2014, Barbara Honegger came forward to verify its genuineness by revealing that she was the source for the quote. Honegger stated:

I am the source for this quote, which was indeed said by CIA Director William Casey at an early February 1981 meeting of the newly elected President Reagan with his new cabinet secretaries to report to him on what they had learned about their agencies in the first couple of weeks of the administration. The meeting was in the Roosevelt Room in the West Wing of the White House, not far from the Cabinet Room. I was present at the meeting as Assistant to the chief domestic policy adviser to the President. Casey first told Reagan that he had been astonished to discover that over 80 percent of the 'intelligence' that the analysis side of the CIA produced was based on open public sources like newspapers and magazines. As he did to all the other secretaries of their departments and agencies, Reagan asked what he saw as his goal as director for the CIA, to which he replied with this quote, which I recorded in my notes of the meeting as he said it. Shortly thereafter I told Senior White House correspondent Sarah McClendon, who was a close friend and colleague, who in turn made it public. Barbara Honegger.⁷⁰⁷

Note the two significant things revealed by CIA Director Casey: 1) The CIA relies on public sources for over 80 percent of its intelligence; and 2) He, as Director of the CIA, stated that his goal was to provide disinformation to the American public, and that his success in that goal would be when everything the public

believed was false. Why wouldn't Director Casey make it his goal to fix the woeful intelligence gathering of the CIA that he was astonished to discover? Because he understood that intelligence gathering is not the primary purpose of the CIA, and therefore it was not a priority to fix that deficiency. The CIA's chief purpose is to provide disinformation to the American public as a means of controlling the people. His goal, as director, was to further the CIA's principal purpose.

How is the CIA able to run a disinformation campaign to the degree that it can influence the American public? Dave McGowan, in his book, *Derailing Democracy*, quotes William Colby, former CIA Director, saying: "The Central Intelligence Agency owns everyone of any significance in the major media."⁷⁰⁸ A CIA operative discussed with Philip Graham, editor Washington Post, how easy it was for the CIA to buy influence over journalists willing to peddle CIA propaganda and cover stories. "You could get a journalist cheaper than a good call girl, for a couple hundred dollars a month."⁷⁰⁹

Michael Collins Piper, in his book *Final Judgement*, reveals the CIA subversion of the American media, particularly with regard to covering up the CIA and Israeli Mossad connection to the assassination of President John F. Kennedy.⁷¹⁰ Piper explained that the subversion of the American media by the CIA is pervasive. Piper cited award winning author David Wise, who, in his book, *The American Police State: The Government Against the People*, exposed the role of the CIA in manipulating the media:

The CIA's contacts with the publishing world were not confined to attempts to suppress books. Through the U.S. Information Agency as a 'cut-out,' the CIA subsidized major publishers to produce books, some of which were then sold in the United States bearing no government imprint to warn the unsuspecting purchaser. In 1967

publisher Frederick A. Praeger conceded he had published 'fifteen or sixteen' books for the CIA. By the mid-sixties, more than \$1 million had been spent by the government on its 'book development' program. The Senate intelligence committee estimated that by 1967, the CIA had produced, sponsored, or subsidized 'well over 1,000 books' here and abroad.⁷¹¹

Wise reveals that "the CIA operated two news services of its own in Europe. These 'proprietarys,' or CIA cover companies, serviced American newspapers; one had more than thirty U.S. subscribers."⁷¹² The thirty U.S. subscribers to whom Wise refers are newspapers and other publishing concerns. Those U.S. media outlets then parrot the CIA propaganda, which, in turn, influences public opinion and behavior.

Indeed, it seems that the Washington Post had developed into a virtual department of the CIA. Alex Constantine reveals:

Former Washington Post publisher Philip Graham "believing that the function of the press was more often than not to mobilize consent for the policies of the government, was one of the architects of what became a widespread practice: the use and manipulation of journalists by the CIA" This scandal was known by its code name Operation MOCKINGBIRD. Former Washington Post reporter Carl Bernstein cites a former CIA deputy director as saying, "It was widely known that Phil Graham was someone you could get help from"⁷¹³

Carl Bernstein, in his 1977 article for Rolling Stone, *The CIA and the Media*, recounts a briefing of members of the Senate Intelligence Committee by William B. Bader, former CIA

intelligence officer, who was hired by the Senate to head the Senate investigation into CIA influence in the media. Bader told the Senate Committee members: "There is quite an incredible spread of relationships. You don't need to manipulate Time magazine, for example, because there are [Central Intelligence] Agency people at the management level."⁷¹⁴ Bader's investigation provided a low-end estimate of 400 journalists who were CIA shills. Those 400+ "working journalists" included all areas of news reporting, from top management to reporters, editors, correspondents, and photographers. The CIA influence also reached into book publishers, trade publications, and newsletters.⁷¹⁵ Bernstein explained that "Colby, Elder and Rogovin also implored individual members of the [Senate] committee to keep secret what the staff had found. 'There were a lot of representations that if this stuff got out some of the biggest names in journalism would get smeared,' said another source."⁷¹⁶ Bernstein revealed that a senator who was the object of the Agency's lobbying later said: "From the CIA point of view this was the highest, most sensitive covert program of all.... It was a much larger part of the operational system than has been indicated."⁷¹⁷

Why is the CIA so adamant that the lid be kept on their influence over the media? Because, the media is parroting propaganda that influences the very thoughts of the population. The media is used not to inform the people, but rather as a tool of control over the masses. The CIA subversion of the media has turned the idea of a free press into a charade. Thomas Jefferson once said that "the man who reads nothing at all is better educated than the man who reads nothing but newspapers." That statement is as true today as it was in Jefferson's day.

The CIA subversion of the media is effective because it is generally not known. The general population of the United States believes that the major media outlets are providing them with unbiased news. In fact, nothing could be further from the truth.

The false belief that the news media is independent and free from government influence is why the government propaganda spewed from the major media outlets is so effective. The major media outlets are part and parcel of a mass mind control operation. Michael Rivero explains:

As terrible as it is to live in a nation where the press is known to be controlled by the government, at least one has the advantage of knowing the bias is present, and to adjust for it. In the United States of America, we are taught from birth that our press is free from such government meddling. This is an insidious lie about the very nature of the news institution in this country. One that allows the government to lie to us while denying the very fact of the lie itself.⁷¹⁸

One must understand that the CIA is simply a tool of mass disinformation under the control of the Jewish elite. Government is force, we must look behind the labels (e.g., CIA) to those who control that force. The CIA, as all agencies of government, are the means of control, but the true controllers are hidden behind the scenes, pulling the strings in secret.

Edward Bernays was named one of the 100 most influential Americans of the 20th century by Life magazine. Bernays was the nephew to the wicked founder of psychoanalysis, Sigmund Freud. Bernays was a Jewish expert on propaganda, who was in the service of the powerful elite. Bernays famously wrote in 1928:

The conscious and intelligent manipulation of the organized habits and opinions of the masses is an important element in democratic society. Those who manipulate this unseen mechanism of

society constitute an invisible government which is the true ruling power of our country. We are governed, our minds are molded, our tastes formed, our ideas suggested, largely by men we have never heard of. This is a logical result of the way in which our democratic society is organized. Vast numbers of human beings must cooperate in this manner if they are to live together as a smoothly functioning society. Our invisible governors are, in many cases, unaware of the identity of their fellow members in the inner cabinet. They govern us by their qualities of natural leadership, their ability to supply needed ideas and by their key position in the social structure. Whatever attitude one chooses toward this condition, it remains a fact that in almost every act of our daily lives, whether in the sphere of politics or business, in our social conduct or our ethical thinking, we are dominated by the relatively small number of persons a—trifling fraction of our hundred and twenty million—who understand the mental processes and social patterns of the masses. It is they who pull the wires which control the public mind.⁷¹⁹

Be mindful that Bernays was a proponent of propaganda as a tool to manipulate the behavior of the masses. He was in the service of the very “invisible governors” whom he praised for their “natural leadership” and “ability to supply the needed ideas.” Bernays explained matter-of-factly that “it is they who pull the wires which control the public mind.” Bernays felt that these governors were necessary for “the orderly functioning of our group life.”⁷²⁰

In order for the “invisible governors” to manipulate the population through propaganda, it is necessary for them to control

the mass media. Evidence presented before United States Congress in 1917 proved that J.P. Morgan, who was the American agent for the international Jewish (Rothschild) banking interests, purchased control over the major media in the United States.⁷²¹ That control continues today. According to some researchers, Jews own or control 96% of the world's major media outlets to include newspapers, television, movies, and other media.⁷²²

On February 17, 1917, Congressman Oscar Callaway presented the following facts before the United States Congress which explained the successful efforts of J.P. Morgan and his cabal to control public opinion in order to involve the United States in World War I.

Mr. CALLAWAY. Mr. Chairman, under unanimous consent, I insert in the record at this point a statement showing the newspaper combination, which explains their activity in this war matter, just discussed by the gentleman from Pennsylvania,

[Mr. Moore]: In March, 1915, the J.P. Morgan interests, the steel, shipbuilding, and powder interests, and their subsidiary organizations, got together 12 men high up in the newspaper world and employed them to select the most influential newspapers in the United States and sufficient number of them to control generally the policy of the daily press of the United States.

These 12 men worked the problem out by selecting 170 newspapers, and then began, by an elimination process, to retain only those necessary for the purpose of controlling the general policy of the daily press throughout the country. They found it was only necessary to

purchase the control of 25 of the greatest newspapers.

The 25 papers were agreed upon; emissaries were sent to purchase the policy, national and international, of these papers; an agreement was reached; the policy of the papers was bought, to be paid for by the month; an editor was furnished for each paper to properly supervise and edit information regarding the questions of preparedness, militarism, financial policies, and other things of national and international nature considered vital to the interest of the purchasers.

This contract is in existence at the present time, and it accounts for the news columns of the daily press of the country being filled with all sorts of preparedness argument and misrepresentations as to the present condition of the United States Army and Navy and the possibility and probability of the United States being attacked by foreign foes.

This policy also included the suppression of everything in opposition to the wishes of the interests served. The effectiveness of this scheme has been conclusively demonstrated by the character of stuff carried in the daily press throughout the country since March, 1915. They have resorted to anything necessary to commercialize public sentiment and sandbag the national congress into making extravagant and wasteful appropriations for the Army and Navy under the false pretense that it was necessary. Their stock argument is that it is "patriotism." They are playing on every prejudice and passion

of the American people.⁷²³

How successful have the Jews and their fellow conspirators been in controlling public knowledge and opinion? Read and weep over the sad truth as John Swinton, the former Chief of Staff for the New York Times, explains the state of the supposed free press in the United States in a speech before the New York Press Club in 1953.

There is no such thing, at this date of the world's history, in America, as independent press. You know it and I know it. There is not one of you who dares to write your honest opinions, and if you did, you know beforehand that it would never appear in print. I am paid weekly for keeping my honest opinion out of the paper I am connected with. Others of you are paid similar salaries for similar things, and any of you who would be so foolish as to write honest opinions would be out on the streets looking for another job. If I allowed my honest opinions to appear in one issue of my paper, before twenty-four hours my occupation would be gone. The business of the journalists is to destroy the truth; to lie outright; to pervert; to vilify; to fawn at the feet of mammon, and to sell his country and his race for his daily bread. You know it and I know it and what folly is this toasting an independent press? We are the tools and vassals of rich men behind the scenes. We are the jumping jacks, they pull the strings and we dance. Our talents, our possibilities and our lives are all the property of other men. We are intellectual prostitutes.⁷²⁴

Many may wonder just how this media control is leveraged by the CIA. The media coverage of the 9/11 attacks

offers one example. The mass media was instrumental in the deception of the American people. The major media outlets played a key role in the deception of attacks of 9-11, by laying the blame on innocent patsies, concealing the treasonous conduct of government officials and the acts of war against the United States by agents of a foreign nation (Israel), and actively relaying a deceptive portrayal of what really took place on 9-11.

Prior to 9-11-01 there had never been a case where a steel structured high-rise tower has collapsed as a result of fire. All are aware that on 9-11-01 the twin towers at the World Trade Center (WTC) collapsed. Many are unaware, even today, that a third tower also collapsed that day (WTC 7). The government would have us believe that Towers 1,2, and 7, all collapsed as a result of fire. The collapse of World Trade Center Tower Seven on September 11, 2001, at 5:20 p.m. reveals the media involvement in the attacks.

Let's set the stage for the collapse of Tower 7. Tower Seven had 47 stories, which made it 600 feet tall. Aside from the WTC Twin Towers, it was one of the tallest buildings in lower Manhattan. It was separated from Twin Towers by a city block. Tower 7 was fully 355 feet away from the north face of the North Tower, and Tower 6 stood between it and the North Tower. The South Tower was even further away. Tower 7 was no closer to the Twin Towers than any of the other surrounding buildings which suffered only superficial damage. Tower 7 was not struck by either of the alleged planes (which we now know didn't exist) or significant debris from Towers One or Two, yet mysteriously two limited fires broke out in the building and it suddenly collapsed later in the evening of September 11.

Interestingly, the 23rd floor of Tower Seven received 15 million dollars worth of renovations, including independent and secure air and water supplies and bullet and bomb resistant windows designed to withstand 200 MPH winds. The renovation

was intended to be used by the Mayor of New York, Rudolph Giuliani, as an emergency command center. Part of the reason for the command center was the 1993 bombing of the World Trade Center. The 23rd floor was ideal for a command center because it had an unobstructed view of the north sides of the Twin Towers, which since the 1993 bombing were considered prime terrorist targets. Tower 7 was a well-built 100% steel-framed skyscraper. It had a series of 58 columns ringing its perimeter, and a bundle of 25 columns in its core.⁷²⁵ Suspiciously, on the day of the 9/11 attacks, Mayor Giuliani and his entourage alleged that they set up shop in a different location and did not use the special bunker designed precisely for such an event. Giuliani stated that Tower 7 was evacuated immediately upon the first plane impact.

The command center was at 7 World Trade Center, which is the building that was north of the World Trade Center that went down in the afternoon. It went down maybe 4 or 5 o'clock in the afternoon. **But from the very moment that the first plane hit, 7 World Trade Center was evacuated.**⁷²⁶

The pictures below illustrate just one example of the active involvement of the mass media in spreading disinformation in the aftermath of the attacks on 9/11. The pictures are frames from a BBC live broadcast on 9-11-01 that announced the collapse of WTC building 7 (also known as the Solomon Brothers Building), in the late afternoon on the day of the 9/11 attacks.⁷²⁷ At the time of the broadcast, the World Trade Center (WTC) Towers 1 and 2 had already collapsed earlier that morning.

The BBC announcer, Phil Hayton, was announcing matter-of-factly that the Solomon Brothers Building (WTC 7) had collapsed (20 minutes before the actual collapse). Hayton repeats the announcement again at 5:07 p.m. EST. At approximately 5:07 p.m. EST, the newscaster states: "Now more on the latest building

collapse in New York, you might have heard a few moments ago us talking about the Solomon Brothers Building collapsing, and indeed it has. . . . Jane what more can you tell us about the Solomon Brothers Building and its collapse?” The curious thing about the broadcast video is that the building did not collapse until 13 minutes later, at approximately 5:20 p.m. EST.

After the announcer tells the audience that Solomon Brothers Building (WTC 7) had collapsed, he goes to a live feed to Jane Standley on the scene in New York. Initially her head blocks WTC 7, but she later moves and shows the audience the smoke rising from the collapse site of towers 1 and 2. When she does that you can see WTC 7 clearly standing in the background. When she resumes her appearance on the screen you can see WTC 7 in the background over her left shoulder and to the left of her left ear.



Figure 134: BBC broadcasting the collapse of the 47 story WTC 7 building (Solomon Brothers Building) 13 minutes before its collapse.

Someone at the BBC jumped the gun and had the script read too early. Apparently, the conspirators got discombobulated

over the time difference between London and the New York and went with their orchestrated story of the WTC 7 collapse before it actually happened. This is evidence that 9/11 was scripted in advance, and that the major media outlets were part of the conspiracy.

The BBC has received much attention and a lot of inquiries over their 9-11-2001 broadcast predicting the collapse of WTC Tower 7. It took the BBC until February 27, 2007, to respond to the inquiries, by publishing a short response from Richard Porter.⁷²⁸ Think about that. This is a news organization that is supposed to be in the business of gathering news and rapidly disseminating an accurate account of events to the public. It took them years to respond to inquiries about their prediction of the collapse of Tower 7. That is the behavior that is consistent with someone who is not quite sure what to say and wants to take their time to ensure that they do not say anything that might later turn out to be incriminating.

The problem in which the BBC finds itself is that the circumstances of the pre-reporting on 9-11-2001 are so compellingly incriminating that no explanation will mitigate its guilt. They have, so to speak, been caught red-handed. The only thing that they can do is either admit guilt, which they are not going to do, or try to cover their tracks with lies, which is what they have done. The BBC response is quite revealing and incriminating. The most notable thing in its response is that the BBC simply makes assertions without any supporting evidence, as though a denial is sufficient. The BBC stated:

We're not part of a conspiracy. Nobody told us what to say or do on September 11th. We didn't get told in advance that buildings were going to fall down. We didn't receive press releases or scripts in advance of events happening.⁷²⁹

The BBC states that they are not part of a conspiracy and that nobody told them in advance that the buildings would fall down on September 11th. However, if they broadcast an event that nobody could possibly foresee, and then the event takes place exactly as they pre-reported, that clearly indicates that they had prior knowledge of the event. Clearly, the BBC had an advance script of the 9/11 attacks. That makes them accomplices.

Their pre-reporting was more than a prediction of the event, it was a reporting of the event before it happened. If the BBC had said that Tower 7 “would soon collapse” they would have some explaining to do. People would want to know how they knew it was going to collapse. However, the BBC did not say Tower 7 would “soon collapse;” the BBC announced that Tower 7 had already collapsed. That is doubly suspicious, because it proves that they had a script about the collapse of Tower 7 and were reading from the script. The BBC made a mistake by reading the script too early.

The BBC premature reporting of Tower 7's collapse is more than a mere prediction of an event; it is a reporting of an unforeseeable event that actually occurred just as it was reported, but the report was aired before the unforeseeable event occurred. The only way that could happen is if the BBC had a script of the planned events of 9-11-2001 ahead of time. The only source for such a script had to be from the perpetrators. That puts the BBC in the middle of the 9/11 conspiracy and cover-up. The BBC denial does not address that point at all.

When Phil Hayton, the BBC announcer who is seen on screen speaking with Jane Standley, was apprised of the suspicious collapse of WTC and the BBC broadcast suggesting foreknowledge by the BBC, he did not even try to argue the point. Hayton had to agree that it seems there is a conspiracy. He said: “I sense that you think there’s a conspiracy here-but you might be right.”⁷³⁰



Figure 135: Later in the BBC broadcast there is a studio shot live from England, with Phil Hayton sitting at his studio desk, showing the live feed from New York of Jane Standley with WTC 7 Still standing behind her to the left of her left ear. However, the screen script announces that the Solomon Brothers Building (WTC 7) “has also collapsed.”

The official BBC response through Richard Porter gets worse:

We no longer have the original tapes of our 9/11 coverage (for reasons of cock-up, not conspiracy).⁷³¹

A cock up? That is quite simply incredible. The BBC, which is known for its meticulous record keeping and storage of news archives going back over 50 years, inexplicably loses live news footage documenting the crime of the century! That explanation does not pass the smell test. How could the news agency of record for Britain, who is by law required to keep records of broadcasts, lose those records? The answer is that they did not lose them; the records are clear evidence that support a finding that the BBC was part of the 9/11 conspiracy. This entire event, with an examination of the events surrounded the supposed “missing” original tapes is recounted in this author’s book, *9/11-Enemies Foreign and Domestic*. While the BBC is a British media outlet, *9/11-Enemies Foreign and Domestic* documents clear evidence of the U.S. mass media’s active involvement as accessories in spreading disinformation about the 9/11 attacks.

The 9/11 attacks were false flag attacks for a purpose. Vice President Dick Cheney, Defense Secretary Rumsfeld, and Deputy Defense Secretary Wolfowitz are listed as signatories on the June 3, 1997, Statement of Principles for the Project for a New American Century (PNAC).⁷³² PNAC was a Zionist controlled think tank. PNAC ceased operations in 2006. Not to worry, the Zionists behind PNAC have reconstituted a new Zionist think tank to replace PNAC called Foundation for Defense of Democracies (FDD). As did PNAC before it, FDD advocates that the U.S. fight wars on behalf of Israel. For example, the neoconservative warmongers at FDD have issued a report calling for regime change in Syria and for the U.S. to use military strikes with missiles and warplanes to destroy Iran’s nuclear capabilities. PNAC issued a paper (*Rebuilding America’s Defenses*) on September 2000, one year before the 9-11-2001 attacks. That document advocated transforming the United States politically and militarily.

The September 2000 PNAC strategy paper advocated for the United States to increase its defense budget, transform the military to use advanced technologies, redefine the military to

perform constabulary missions throughout the world, and maintain sufficient forces to fight and win multiple large scale wars. The September 2000 paper stated: "Further, the process of transformation, even if it brings revolutionary change, is likely to be a long one, absent some catastrophic and catalyzing event - like a new Pearl Harbor."⁷³³ The 9/11 attacks would certainly qualify as a new Pearl Harbor.

The strange inaction of Wolfowitz and Rumsfeld on 9-11-2001 is revealing when it is viewed in the light of the need for a "new Pearl Harbor" expressed by their September 2000 PNAC report. The 9/11 attacks certainly brought about a political and military "revolutionary change" as envisioned in their report. The proof is in the pudding. The United States has in fact been transformed politically and militarily as a result of the 9/11 attacks.

The 9/11 attacks reveal who is the real power behind the U.S. Government. All one needs to do is to look to who benefitted the most from the 9/11 attacks. The answer is obvious - Israel. The agents of Israel in both the government and the media worked together to accomplish the dirty deed.

Those working for a New World Order under their god, Satan, have convinced the world that the earth is a spinning globe careening through the empty vacuum of space. That is the mother of all deceptions, which is the cornerstone of the New World Order. Having pulled off that deception, all other deceptions, like the 9/11 attacks, are child's play for them. Without the heliocentric deception, which drives God from the minds of men, they could not hope to hoodwink the masses as they secretly work out their plans for world domination through their implementation of the Hegelian dialectic.

The Zionists must keep a lid on the flat earth. Satan's minions know that if the flat earth is generally known, Satan's

plan for a world dominion will be crushed, and he will have to start all over again. Read in the book of Acts how the disciples of Christ responded to the threatenings of the Jewish elders and chief priests who “commanded them not to speak at all nor teach in the name of Jesus.” Acts 4:18.

And being let go, they went to their own company, and reported all that the chief priests and elders had said unto them. And when they heard that, they lifted up their voice to God with one accord, and said, Lord, thou art God, which hast made heaven, and earth, and the sea, and all that in them is: Who by the mouth of thy servant David hast said, Why did the heathen rage, and the people imagine vain things? The kings of the earth stood up, and the rulers were gathered together against the Lord, and against his Christ. (Acts 4:23-26)

Notice how the Christians, with a true knowledge of God, immediately resisted the authority of the Jewish elders and chief priests and understood that the Jewish leaders were heathens in a conspiracy with the rulers of the world against God. The knowledge of the gospel of Christ had caused the people to see the massive world conspiracy against God and Christ. The Jewish religious leaders understood that the gospel of Jesus Christ had opened the eyes of the people, and they had lost their hold on them. The Jewish hierarchy learned their lesson. They knew that in order to rule over the people it was necessary to drive from them any true knowledge of God. God explains that “heaven is my throne, and earth is my footstool.” (Acts 7:49) That is the kernel to understanding who God is and how close he is to us. The Jews cannot let that be known.

Their heliocentric model removes heaven and replaces it with the empty vacuum of space. If people can be convinced that

there is no heaven, which is the throne of God, then it is easy to convince men that there is no God at all. Religious leaders know that most people have a need for a god, and so they conjure up a false, pantheistic god, who serves their ends. Although people will pay lip service to believing in God, it is not the true, sovereign God of the bible, whose throne is heaven, and whose footstool is the earth.

Even many so-called “Christian” churches preach a perverted gospel with a false Christ. Under the true gospel of Jesus Christ, salvation is by the grace of God alone through faith in Jesus Christ alone. John 1:1-14, 14:6, Acts 4:12, and Ephesians 2:8. There is no salvation but through Jesus Christ. Since, however, the false gospel is inspired by the Jews, it provides for salvation without Jesus Christ, and in particular for the Jews. For more information on the corrupt Judaized gospel, read this author’s books: *The Anti-Gospel*, *Solving the Mystery of Babylon the Great*, and *Bloody Zion*. It is this method of subtle deception that the god of this world, who is Satan, uses to deceive people into serving him.

But if our gospel be hid, it is hid to them that are lost: In whom **the god of this world hath blinded the minds of them which believe not**, lest the light of the glorious gospel of Christ, who is the image of God, should shine unto them. (2 Corinthians 4:3-4)

29

The Religion of Modern Cosmology

Marshall Hall summarizes the satanic conspiracy behind the Jewish Kabbalistic foundation of the so-called “science” of heliocentrism, the big bang theory, evolution, and modern psychology with the largely successful objective of degenerating society and corrupting the “Christian” church.

Riding the first waves of the Copernican Revolution in the 1550's, 60's, and 70's was Kabbalist Isaac Luria. He understood how fellow Kabbalist Nachmanides' 13th century Big Bang Paradigm could actually be built upon the Copernican basis, and he promptly tied that understanding in with Kabbalist Ben HaKana's 1st century calculation of a 15 billion year old universe...which only another Kabbalist would be privy to. At first, it was not clear to me why Luria is given so much credit for "prophesying" Big Bangism 400 years ahead of its establishment. After all, Nachmanides had the same idea over 300 years before Luria did and he also understood that a Big Bang Cosmology could

never be built without first establishing a contra-Biblical heliocentric foundation. Luria, however, had the advantage of living at a time when a Gentile Churchman (Copernicus) would push that foundational moving-earth concept onto the world stage. The fact that Luria virtually pounced upon connecting the dots in the Rabbis HaKana and Nachmanides' Big Bang Cosmological Paradigm 400 years before it was brought to fulfillment attests to the fortuitous launching of the necessary Copernican foundation to that Paradigm during his lifetime much more than any "prophetic" ability attached to him. Given the prospects of a "scientifically" accepted rotating earth model--and fortified with a centuries-old secret plan to destroy Bible Credibility by destroying its "Origins Scenario"--the path was cleared for Kabbalic "science" to conquer the Life Sciences with "evolutionism". That done, Social and Behavioral "Sciences" and "Educational Psychology" and evolution based Christianity could proceed to transvaluate Christian morals and ethics until they conformed to Talmud/Kabbala morals and ethics.

Although Nachmanides understood that a heliocentricity model was the required first step on the road to legitimizing a relativistic, big bang, expanding universe cosmological fantasy which would establish eons of evolutionism and destroy all Bible credibility, he didn't have the mathematical mechanism attached to Copernicanism that gave it "scientific" status. Luria was the right man in the right place at the right time (1534-1572) to declare something like

this in the Kabbalic Inner-Sanctum: "Now we have the mechanism that can make the Cosmology of the sages work!"...in much the same way 300 years later that Karl Marx could write to Lassalle that Darwin's book had given "the death blow to God" and further exult: "Darwin's book...serves me as a basis for the class struggle [communism] in history." ...

If one insists that the issue is about "Science" when referring to the mutually exclusive Creation Models of the Kabbala and the Bible, one needs a definition of what "Science" is. All dictionaries agree that the root word of "Science" is the Latin *scire* which means: "to know". There is one uncomplicated way of knowing something, and that way is to observe it and to note that no matter how many times that something is observed it always does the same thing. Observable and repeatable = Known, and Known = "science". All else invites deception. ...

"Seeing is believing" is an old adage that upholds the observational requirement for anything that is defined as known, i.e., as "scientific". If no one has ever, ever, ever actually seen a "hypothetical something" about the Cosmos take place, can that "hypothetical something" be "known"? Obviously not. Can that "hypothetical something" be truly "scientific" if it is not known? Not according to "something" called a dictionary. It can be "science" falsely so called which causes man to err" (I Tim.6:20, 21), but it cannot be "true science". (Today's "science" is Orwellian doublespeak.).⁷³⁴ (parenthetical in original)

What are the religious tenets found in the Kabbalah, which is the source for heliocentrism? J.F.C. Fuller in his book *The Secret Wisdom of Qabalah* explains the secret doctrine of the Kabbalah:

In this duality of good and evil the danger is that the uninitiated see two separate entities: they see good as God and evil as Satan. Consequently, they love the one and hate the other....This is the essential ignorance which separates Christianity from Judaism; for to the Christians' salvation consists in the conquest of evil - that is, in its separation from the good....The personification of evil in the form of Satan as the God of Evil is the heresy which separates Christianity from Judaism.⁷³⁵

Marshall Hall summarizes the satanic doctrines of the Jewish Kabbalah:

Satan is not a created "entity" as the Bible and Christianity describe him to be (Col. 1:16). No, no, says the Kabbalist; that is the "essential ignorance which separates Christianity from Judaism." Making Satan the God of Evil "is heresy to the Kabbalist." The Kabbalist "Creator" is one entity, good and evil; a monotheistic amalgam of good and evil. (This is the same hermaphroditic ogre worshipped as the Baphomet creator/architect g'd found in many mystical—always secret—Societies which have higher orders of these "illuminated" ones in control).⁷³⁶

While many rabbis throughout history held a geocentric view and even believed in a flat earth, modern day rabbis were

quick to yield to the heliocentric view, once the science of heliocentricity gained popularity. Why the quick capitulation? Because both heliocentrism and a spherical earth were among the most esoteric occult beliefs of Judaism. For example, the highly respected Talmudic scholar Baal Hamaor, R' Zerachiah HaLevy (1125-1186), stated that the world is a sphere, and it can be divided into four quarters.⁷³⁷

The Zohar, at vol. 3, on the portion of Vayikra, fol. 9b-10a (according to the translation of the Sulam, sections 134-145) states:

In the book of Rav Hamnuna Sava it is explained in more detail that all the world rolls in a circle like a ball, these down and these up (that is, the creatures on the sphere are in opposition to each other, and the seven parts of the ball are the seven lands (the Sulam commentary)), and all the creatures in six lands are different in their appearances in accordance with the differences of air in each place, and they stand on their feet as other humans. Therefore there are places in the world that when it is light for those on one side of the sphere it is dark for those on the other side of the sphere, for these it is day while for those it is night; and there is a place in the world where it is always day and there is no night, except for a few moments.⁷³⁸ (parenthetical in original)

We find in the Babylonian Talmud in Tractate Abodah Zarah at Folio 41a that Jews are prohibited from having images, if the image is holding an orb, because that would imply that the idol “grasps the whole world as though it were a ball.”⁷³⁹ The Jerusalem Talmud Tractate Abodah Zarah has a variant, wherein it states that an idol holding a sphere indicates “that it sacrifices itself for the whole globe.”⁷⁴⁰

The Jerusalem Talmud at Avoda Zara Chapter 9, Folio 42c states that “R' Yonah said: When Alexander the Macedonian wanted to go back, he flew [on the back of an eagle] higher and higher until he saw the earth as a ball and the sea as a plate.”⁷⁴¹ (brackets in original)

That suggests that some Jews from antiquity held out the view that the world was in the shape of a round ball. Indeed, the Zohar on Vayikra p. 10a states: "In the book of Rav Hamnuna Sava it is explained that all the world rolls in a circle like a ball. ... There are places in the world that when it is light for those on one side of the sphere it is dark for those on the other."⁷⁴²

Who was it that trotted out the Kabbalah inspired heliocentric model? None other than a Roman Catholic priest, Nicolaus Copernicus (1473-1543). George William Rutler, writing for the Catholic Education Resource Center, reveals that Copernicus was a Catholic priest who was the temporary administrator of the diocese of Frauenburg. His priestly status was confirmed by DNA analysis that established that Copernicus was buried in the Polish cathedral of Frombork.⁷⁴³

That is not surprising since Roman Catholicism is essentially Kabbalistic Judaism all dressed up for Gentiles. That little known fact is explained in this author's book, *Solving the Mystery of Babylon the Great*.

There is a clear parallel between the traditions of the Pharisees of old and those of modern Roman Catholic priestcraft. The Roman Catholic Church follows the practice of the Jews and calls the combination of man's tradition and God's word "the Word of God." To a Protestant Christian the word of God means the Holy Bible. However, to the Roman Catholic, it means the Holy Bible plus their traditions.

Sacred Tradition and Sacred Scripture make

up a single sacred deposit of the Word of God.
CATECHISM OF THE CATHOLIC CHURCH, §
 97, 1994.

[T]he church, to whom the transmission and interpretation of Revelation is entrusted, **does not derive her certainty about all revealed truths from the holy Scriptures alone. Both Scripture and Tradition must be accepted and honored with equal sentiments of devotion and reverence.** *Id.* at § 82 (emphasis added).

The Catholic Church has grafted its tradition onto the word of God. With this sleight of hand they have deceived people into following doctrines that are directly contrary to God's word as found in the Holy Bible.

The very idea of adding traditions to Gods word is based upon the practice of the Jews. Michael Hoffman explains: "The Talmud is Judaism's holiest book (actually a collection of books). Its authority takes precedence over the Old Testament in Judaism. Evidence of this may be found in the Talmud itself, Erubin 21b (Soncino edition): 'My son, be more careful in the observance of the words of the Scribes than in the words of the Torah (Old Testament).'"⁷⁴⁴

In that section of the Talmud there is a distinction made between the Torah and the Talmud (words of the Scribes). Often, that distinction is not made. Jews often refer to both the Talmud and the Torah as "Torah." As with the Catholic Church calling the combination of their traditions and the bible, the word of God, so also the Jews say that Torah is the combination of their traditions (Talmud and Kabbalah) and the Old Testament. However, in Orthodox Judaism the Jewish traditions contained in the rabbinical writing of the Talmud and Kabbalah supercede and supplant the word of God found in the Old Testament (which is also called the

Tanakh). That same thing is true regarding Catholic traditions that supplant the word of God.

The Jews teach that Moses was given revelation in two forms on Mount Sinai, oral and written. The smaller revelation was the written Torah, the larger revelation was kept orally. “This ‘Oral Torah’ had been transmitted faithfully by the leaders of each generation to their successors, by Moses to Joshua, and then to the elders, then to the prophets, to the men of the Great Assembly, to the leaders of the Pharisees, and finally to the earliest rabbis. The earliest rabbis saw themselves as heirs to the Pharisees.”⁷⁴⁵

In one statement Jesus exposed the lie that the oral traditions of the Jews were given by God to Moses at Mount Sinai. Jesus stated: **“For had ye believed Moses, ye would have believed me: for he wrote of me. But if ye believe not his writings, how shall ye believe my words?”** (John 5:46-47) If the oral traditions had truly been given by Moses, they would have testified to the authenticity of Jesus as Christ. Since the Jews rejected Jesus, because he contravened their traditions, that is proof that their traditions could not have come from Moses. Michael Hoffman explains that one statement by Jesus “crushed the whole beguiling system of indoctrination predicated on the Pharisaic myth of a divinely inspired, oral tradition of the elders.”⁷⁴⁶

Rabbi Ben Zion Bokser admits that the so-called traditions of the Jews that form the foundations of Judaism are entirely extra-biblical. He states that Jews and Christians alike are under the fallacious impression that Judaism is a religion based upon the Hebrew Bible. He states to the contrary that “[m]uch of what exists in Judaism is absent in the Bible, and much of what is in the Bible cannot be found in Judaism. . . . **Judaism is not the religion of the Bible.**”⁷⁴⁷

Judaism is based primarily upon the Kabbalah, Talmud,

and other rabbinical writings. Where there is a conflict between their traditions (Talmud and Kabbalah) and the Old Testament (Torah), their traditions take precedence. Jews claim that the Talmud is partly a collection of traditions Moses gave them in oral form. Those traditions had not yet been written down in Jesus' time. Christ condemned the traditions of the Scribes and Pharisees, because those traditions (which later became written down in the Talmud) nullify the teachings of the Holy Bible. **“Making the word of God of none effect through your tradition, which ye have delivered: and many such like things do ye.”** (Mark 7:13)

Rabbi Joseph D. Soloveitchik is regarded as one of the most influential rabbis of the 20th century. He is viewed as the unchallenged leader of Orthodox Judaism and the top international authority on halakha (Jewish religious law). “Soloveitchik was responsible for instructing and ordaining more than 2,000 rabbis, “an entire generation” of Jewish leadership.”⁷⁴⁸ However, when the N.Y. Times explained his study, the only basis mentioned for his ascendant religious leadership was his study of the Talmud. “Until his early 20s, he devoted himself almost exclusively to the study of the Talmud.”⁷⁴⁹ There was no mention in the article of the esteemed rabbi’s study of the Old Testament (Torah) as the basis for being one of the leading authorities on Jewish law. That is because the Talmud along with the Kabbalah forms the basis for Judaism, and they are largely contrary to the Old Testament (Torah). Hoffman states: “The rabbi's credentials are all predicated upon his mastery of the Talmud.”⁷⁵⁰ “Britain's Jewish Chronicle of March 26, 1993 states that in religious school (yeshiva), Jews are ‘devoted to the Talmud to the exclusion of everything else.’”⁷⁵¹

To add tradition to God’s word is rebellion against God’s command that nothing be added or taken away from his words. “Ye shall not add unto the word which I command you, neither shall ye diminish ought from it, that ye may keep the commandments of the LORD your God which I command you.”

(Deuteronomy 4:2) “What thing soever I command you, observe to do it: thou shalt not add thereto, nor diminish from it.”
 (Deuteronomy 12:32)

There is a terrible curse that comes with adding or taking away from God’s word.

For I testify unto every man that heareth the words of the prophecy of this book, If any man shall add unto these things, God shall add unto him the plagues that are written in this book: And if any man shall take away from the words of the book of this prophecy, God shall take away his part out of the book of life, and out of the holy city, and *from* the things which are written in this book. (Revelation 22:18-19)

The Holy Bible warns us about those who would attempt to turn us away from Christ to follow the traditions of men.

Beware lest any man spoil you through philosophy and vain deceit, **after the tradition of men, after the rudiments of the world,** and not after Christ. (Colossians 2:8)

Wherefore if ye be dead with Christ from the rudiments of the world, why, as though living in the world, are ye subject to ordinances, (Touch not; taste not; handle not; Which all are to perish with the using;) after the commandments and doctrines of men? Which things have indeed a shew of wisdom in will worship, and humility, and neglecting of the body; not in any honour to the satisfying of the flesh. (Colossians 2:20-23)

He answered and said unto them, **Well hath** Esaias prophesied of you hypocrites, as it is written, This people honoureth me with *their* lips, but their heart is far from me. **Howbeit in vain do they worship me, teaching for doctrines the commandments of men. For laying aside the commandment of God, ye hold the tradition of men, as the washing of pots and cups: and many other such like things ye do. And he said unto them, Full well ye reject the commandment of God, that ye may keep your own tradition.** (Mark 7:6-9)

Jesus said: "I am the bread of life: he that cometh to me shall never hunger; and he that believeth on me shall never thirst." (John 6:35) Very simply, Jesus promised salvation to all who believed on him. Adding any other requirement to faith in Jesus corrupts the gospel, resulting in the bread of death rather than the bread of life.

Jesus warned his disciples to beware of the doctrine of the religious leaders of their time. Jesus compared their doctrine to leaven. Only a little leaven of man-made rules works its way through the whole loaf and corrupts God's pure doctrine. The leaven of today's religious leaders is no different; the leaven of tradition corrupts God's pure word. Man's tradition has turned the Bread of Salvation into spiritual poison killing the souls of those who eat of the corrupted loaf.

Then Jesus said unto them, Take heed and beware of the leaven of the Pharisees and of the Sadducees. And they reasoned among themselves, saying, It is because we have taken no bread. Which when Jesus perceived, he said unto them, O ye of little faith, why reason ye among yourselves, because ye have brought no

bread? Do ye not yet understand, neither remember the five loaves of the five thousand, and how many baskets ye took up? Neither the seven loaves of the four thousand, and how many baskets ye took up? How is it that ye do not understand that I spake it not to you concerning bread, that ye should beware of the leaven of the Pharisees and of the Sadducees? **Then understood they how that he bade them not beware of the leaven of bread, but of the doctrine of the Pharisees and of the Sadducees.** (Matthew 16:6-12)

A little leaven leaveneth the whole lump.
(Galatians 5:9)

God wants us to purge out the leaven of man's tradition.

Your glorying *is* not good. Know ye not that a little leaven leaveneth the whole lump? **Purge out therefore the old leaven, that ye may be a new lump, as ye are unleavened. For even Christ our passover is sacrificed for us:** Therefore let us keep the feast, not with old leaven, neither with the leaven of malice and wickedness; but with the unleavened bread of sincerity and truth. (1 Corinthians 5:6-8)

Man's tradition requires works to earn salvation. Salvation, however, is by God's Grace through faith alone on the completed work of Jesus Christ, who paid for all of our sins on the cross. Good works flow from salvation; good works cannot earn salvation.

For by grace are ye saved through faith; and that not of yourselves: it is the gift of God: Not

**of works, lest any man should boast. For we
are his workmanship, created in Christ Jesus
unto good works, which God hath before
ordained that we should walk in them.**
(Ephesians 2:8-10)

The Jewish Encyclopedia acknowledges the Babylonian (a/k/a Chaldean) origins of the Kabbalah (a/k/a Cabala). In addition, the Jewish Encyclopedia explains that Gnosticism flowed from the Jews to the ersatz "Christians." That is yet more authority that Gnosticism flowed from Babylon via the Jewish Gnostics to lay the foundation for the Roman Catholic theology. The esoteric Gnosticism imbued in the Catholic theology was based upon the Jewish Kabbalah.

The Pythagorean idea of the creative powers of numbers and letters, upon which the "Sefer Yez. irah" is founded, and which was known in tannaitic times . . . is here proved to be an old cabalistic conception. In fact, the belief in the magic power of the letters of the Tetragrammaton and other names of the Deity . . . seems to have originated in Chaldea . . . Whatever, then, the theurgic Cabala was, which, under the name of "Sefer (or "Hilkot" Yez. irah,") induced Babylonian rabbis of the fourth century to "create a calf by magic."

* * *

But especially does Gnosticism testify to the antiquity of the Cabala. Of Chaldean origin, as suggested by Kessler . . . and definitively shown by Anz . . . Gnosticism was Jewish in character long before it became Christian.⁷⁵²

Marshall Hall explains how the Jewish Kabbala is the source for the big bang that supposedly caused the universe to spring into existence billions of years ago.

The size of the Universe is now determined by the dictates of the Kabbala. That book--in addition to outlining the "Relativity" concept to allow the 15+ billion year age of the Universe--also outlines the Big Bang and Expanding Universe concepts which give license to claim billions of light year distances to the stars. Both of these myths about the age and size of the Universe have been brought to fruition by a Theoretical Science Establishment which has used NASA's "Origins Program" to establish the Kabbala's reign over all "science".⁷⁵³

Hall quotes a Jewish commentator, who states that "The Ramban [13th century. Rabbi Nachmanides], who refers to what he writes as coming from 'hidden knowledge,' says that this initial creation was something so small and without physical form. This idea that everything originated from a singular point in the universe is what science calls The Big Bang!"⁷⁵⁴

Research has confirmed that the Jewish commentator quoted by Hall is correct. The modern figure of 14 billion years attributed to the age of the universe is not based upon science, but rather a mystical religious belief. This belief that the universe is billions of years old was first announced by Nachmanides. Nachmanides was known as Ramban, which is an acronym of his name, Rabbi Moshe Ben Nachmon (1194-1270 A.D.). Nachmanides was the foremost expert on Jewish religious laws and customs (halakhist) of his age. Ramban was a mystic who incorporated the Jewish Kabbalah into his teachings. He was vehemently against Christianity and often tried to refute Christianity in debates.⁷⁵⁵

Nachmanides interpreted the creation account in Genesis not as six literal, 24 hour days, but rather a much longer period that equaled approximately 15-3/4 billion years. That is very close to the 14+ billion years that is often hypothesized by modern so-called "scientists."⁷⁵⁶

The "big-bang" theory of creation is simply a restatement of Nachmanides' commentary of the creation account. According to Nachmanides, in the beginning (15-3/4 billion years ago) the universe was initially non-corporeal, ethereal, and no larger than a mustard seed. This small mustard seed sized etherea was somehow transformed into matter. Nachmanides describes a universe that came into being from the initial transformation of concentrated matter in the mustard seed sized area, to a point when it suddenly expanded (what scientists today call the "big-bang") into the universe that we see today. The "big-bang" theory began as a religious belief of a Jewish rabbi. Since there is no science that supports it, it remains, in reality, a Jewish religious belief.

Yakov Leib haKohain (a/k/a Lawrence G. Corey, Ph.D., John-Francis, Aziz, Mehemed Effendi, and Kali Dass) is a Jewish Sabbatian Kabbalist, who converted to the Catholic Church, Islam and Hindu Vedanta, respectively. He holds a doctorate degree in Jungian Studies and Comparative Religion.⁷⁵⁷ Yakov Leib HaKohain confirms the Kabbalistic origins of the big-bang theory.

Isaac Luria (1534-1572) -- also known as the "Ari Zaal," or "Divine Rabbi Isaac," -- was, and remains to this day, unarguably the greatest Kabbalist in world history. His doctrines, based entirely on the Old Testament and Zohar, anticipated virtually world-for-word [*sic*]- or at the very least, concept for concept -- the theory of the "Big Bang" origins of the universe in astrophysics. Thus, the cosmogony of a 16th century Jewish Kabbalist was literally validated

by modern science four hundred years later.’

Professor Gerald Schroeder is typical of modern scientists who have tried to reconcile the supposed billions of years old universe with the biblical account of creation within 6 days, which took place approximately 6,000 years ago. Gerald Schroeder is an Orthodox Jewish physicist. Dr. Schroeder received his PhD in nuclear physics and earth and planetary sciences from the Massachusetts Institute of Technology (MIT). He was on the staff of the MIT Physics Department and was a member of the United States Atomic Energy Commission.

Schroeder relies on the Jewish Talmud to interpret the six days of creation to be equivalent to approximately 15 billion years. He states:

The Talmud tells us that the soul of Adam was created at five and a half days after the beginning of the six days. That is a half day before the termination of the sixth day. At that moment the cosmic calendar ceases and an earth based calendar starts. ... that comes out to be 15 billion years. NASA gives a value of about 14 billion years. Considering the many approximations, and that the Bible works with only six periods of time, the agreement to within a few percent is extraordinary. The universe is billions of years old from one perspective and a mere six days old from another. And both are correct!⁷⁵⁹

The problem with Schroeder’s attempt to reconcile the language in the bible with the scientific view of billions of years is that the language in the bible allows no room for such an interpretation.

And God called the light Day, and the darkness

he called Night. And the evening and the morning were the first day. (Genesis 1:5)

And the evening and the morning were the second day. (Genesis 1:8)

And the evening and the morning were the third day. (Genesis 1:13)

And the evening and the morning were the fourth day. (Genesis 1:19)

And the evening and the morning were the fifth day. (Genesis 1:23)

And God saw every thing that he had made, and, behold, it was very good. And the evening and the morning were the sixth day. (Genesis 1:31)

God defined the day and night and described the events of creation as having taken place between the “evening and the morning.” Each day was marked off by “the evening and the morning.” They were literal evenings and mornings. They were literal days. There is no biblical authority for the argument that the days mentioned in the bible spanned millions of years. That is pure sophistry, born out of a heathen desire to strip God of the glory he deserves for having created the heavens and the earth in six literal days, by the exercise of his sovereign will, through his spoken commands. God rested on the seventh day. Genesis 2:2.

According to Schroeder, the six days of creation in Genesis took 14-15 billion years. He accepts the so-called “scientific” findings that creation is 14-15 billion years old but bases his acceptance of that age on the writings of Jewish religious sages. Schroeder states:

One of the most obvious perceived contradictions between Torah and science is the age of the universe. Is it billions of years old, like scientific data, or is it thousands of years, like Biblical data? When we add up the generations of the Bible and then add the secular rulers that followed, we come to fewer than 6000 years. Whereas, data from the Hubbell telescope or from the land based telescopes in Hawaii, indicate the number at 15 billion years plus or minus 10%. In trying to resolve this apparent conflict, I use only ancient biblical commentary because modern commentary already knows modern science, and so it is influenced by what science always [*sic*]. That commentary includes the text of the Bible itself (3300 years ago), the translation of the Torah into Aramaic by Onkelos (100 CE), the Talmud (redacted about the year 400 CE), and the three major Torah commentators. There are many, many commentators, but at the top of the mountain there are three, accepted by all: Rashi (11th century France), who brings the straight understanding of the text, Maimonides (12th century Egypt), who handles the philosophical concepts, and then Nahmanides (13th century Spain), the most important of the Kabbalists. These ancient commentaries were finalized hundreds or thousands of years ago, long before Hubbell was a gleam in his great-grandparent's eye. So there's no possibility of Hubbell or any other scientific data influencing these concepts. That's a key component in keeping the following discussion objective.⁷⁶⁰

Marshall Hall explains how modern science has simply

confirmed the Jewish Kabbalistic religious beliefs about the origins of the universe:

Is the triumph of today's Big Bang Paradigm--which is certified by a Theoretical Science Establishment--a clear confirmation that those ancient mystic Rabbis and Rebbes were supernaturally gifted sages and prophets of God? That's what Kabbalists are saying. Or, is that triumph--which is smashing the cornerstone of Bible credibility and hence of Christianity--a long-laid, supernaturally motivated strategy to destroy God's real plan through Jesus Christ by destroying the Bible's Credibility and replacing the Creation Account with the Kabbala-confirming "creation" scenario, which scenario has been brought to pass by the very "science falsely so called" establishment that Christians were warned about by that exceptional Hebrew from the Tribe of Benjamin, Saul of Tarsus (I Tim. 6:20,21)?⁷⁶¹

Who do we find revealed to the world as the progenitor of the big bang theory? Another Roman Catholic Priest. The Jewish controlled press try their best to conceal the Jewish religious origins of the big bang theory. As is typical of an intelligence operation, the Jewish controlled media have done what is known in the intelligence community as a limited hangout. They admit that the big bang has its origin in religion, but they conceal that it is Babylonian Judaism. They instead steer the public toward their Gentile front men in the Catholic Church, while they remain in the shadows pulling the strings. In a PBS article titled, *Big Bang Theory: A Roman Catholic Creation*, Edgar Herwick claims that it was a Roman Catholic priest who first postulated the big bang theory.

While the Big Bang is as old as the universe itself, our concept of it is still strikingly new — less than 100 years old. And if you dig into its origins, you come across a curious fact.

Atheists, devout Christians, you might want to sit down for this: The Big Bang theory was first proposed by a Roman Catholic priest.

It wasn't just any priest. It was Monseigneur George Lemaître, a brilliant Belgian who entered the [Jesuit] priesthood following his service as an artillery officer in the Belgian army during World War I. He was also an accomplished astronomer and a talented mathematician and physician. After earning his graduate degree in astronomy from the University of Cambridge in England, he came to Boston and spent a year at the Harvard College Observatory before earning his doctorate at MIT. ...

As astonishing as Lemaître's idea was, perhaps equally surprising to us now was the reaction of the church. Lemaître was not jailed by the Pope like Galileo. He was not excommunicated the way Johannes Kepler was by the Lutheran Church. Quite the opposite. In the early 1950s, Pope Pius XII not only declared that the big bang and the Catholic concept of creation were compatible; he embraced Lemaître's idea as scientific validation for the existence of God and of Catholicism."⁷⁶²

Notice that the article from PBS (WGBH) states that the big bang originated only one hundred years ago with a Catholic priest. There is no mention of Jewish Rabbi Nachmanides whose postulation of the big bang predated Lemaitre's theory by approximately 700 years.

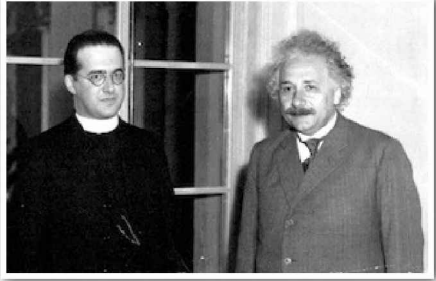

Figure 136: Georges Lemaitre & Albert Einstein, 1933

At a conference in the 1930s, where Lemaitre presented his theory, Einstein reportedly remarked, "This is the most beautiful and satisfactory explanation of creation to which I have ever listened."⁷⁶³

Einstein, who was a Talmudic Jew, looked upon the big bang theory with favor. It seems that Einstein's approval puts the Jewish imprimatur on Lemaitre's big bang theory. Einstein's influence in the Zionist community was such that on November 17, 1952, Einstein was offered the presidency of Israel, which he, with regret, turned down.⁷⁶⁴

It is not insignificant that Lemaitre was a Jesuit. What most do not know is that the Jesuit order is a Crypto-Jewish order of priests. While it may have gentile priests as members, it was founded by Jews and today has close secret ties with other clandestine Jewish organizations. Benjamin Disraeli was a Jew and a former Prime Minister of England; he revealed that the first Jesuits were Jews.⁷⁶⁵ Ignatius of Loyola's secretary, Polanco, was of Jewish descent and was the only person present at Loyola's deathbed. Ignatius Loyola himself was a crypto-Jew of the Occult Kabbalah. A crypto-Jew is a Jew who converts to another religion and outwardly embraces the new religion, while secretly maintaining Jewish practices.

James Lainez (J.G. 1558-1565), who succeeded Ignatius Loyola (J.G. 1541-1556) as the second Jesuit General, was also of Jewish descent. The fourth Jesuit General was a Belgian Jew named Eberhard Mercurian (J.G. 1573-1580).⁷⁶⁶ Jews were attracted to the Jesuit order and joined in large numbers.⁷⁶⁷ Some of the most influential Jesuits in history, such as Francisco Ribera (1537-1591) and Emanuel Lacunza (1731-1801), were Jews. During the 5th General Congregation in 1593 of the 27 Jesuits who proposed changes to the Constitutions, 25 were of either Jewish or Moorish descent.⁷⁶⁸ Many of the Jesuit doctrines are similar to those found in the Kabbalah and Babylonian Talmud. It is possible that the second beast in the book of Revelation is the Jesuit General, who is known as the black pope.

The Abbate Leone explains the prideful arrogance of the Jesuits and their esoteric symbolism signifying their link to Judaism.

The Jewish high-priest wore on his breast the jewel called the oracle. The order of the Jesuits considers itself, under the New Alliance, as the oracle from whence the pope draws his inspiration. They proclaim themselves “the masters of the world, the most learned of mortal men, the doctors of the nations, the Apollos, the Alexanders of theology, prophets descended from heaven, who deliver the oracles in the recumenic councils.” The epitaph which they composed for Loyola strikingly exhibits their love of grandiloquence, and their overweening pride. It runs thus: — “Whoever thou art who conceivest in thy mind the image of Pompej the Great, of Caesar, and of Alexander, open thine eyes to the truth, and thou wilt learn from this marble that Ignatius was the greatest of conquerors.”⁷⁶⁹

John Torell explains the Jewish origins of the Jesuit order.

The Illuminati order was not invented by Adam Weishaupt, but rather renewed and reformed. The first known Illuminati order (Alumbrado) was founded in 1492 by Spanish Jews, called "Marranos," who were also known as "crypto-Jews." With violent persecution in Spain and Portugal beginning in 1391, hundreds of thousands of Jews had been forced to convert to the faith of the Roman Catholic Church. Publicly they were now Roman Catholics, but secretly they practiced Judaism, including following the Talmud and the Cabala. The Marranos were able to teach their children secretly about Judaism, but in particular the Talmud and the Cabala, and this huge group of Jews has survived to this very day. After 1540 many Marranos opted to flee to England, Holland, France, the Ottoman empire (Turkey), Brazil and other places in South and Central America. The Marranos kept strong family ties and they became very wealthy and influential in the nations where they lived. But as is the custom with all Jewish people, it did not matter in what nation they lived, their loyalty was to themselves and Judaism.⁷⁷⁰

* * *

In 1491 San Ignacio De Loyola was born in the Basque province of Guipuzcoa, Spain. His parents were Marranos and at the time of his birth the family was very wealthy. **As a young man he became a member of the Jewish Illuminati order in Spain. As a cover for his crypto Jewish activities, he became very active as a**

Roman Catholic. On May 20, 1521 Ignatius (as he was now called) was wounded in a battle, and became a semi-cripple. Unable to succeed in the military and political arena, he started a quest for holiness and eventually ended up in Paris where he studied for the priesthood. In 1539 he had moved to Rome where he founded the "JESUIT ORDER," which was to become the most vile, bloody and persecuting order in the Roman Catholic Church. In 1540, the current Pope Paul III approved the order. At Loyola's death in 1556 there were more than 1000 members in the Jesuit order, located in a number of nations.⁷⁷¹

Setting up the Jesuit order, Ignatius Loyola devised an elaborate spy system, so that no one in the order was safe. If there was any opposition, death would come swiftly. The Jesuit order not only became a destructive arm of the Roman Catholic Church; it also developed into a secret intelligence service. **While the Popes relied more and more on the Jesuits, they were unaware that the hard core leadership were Jewish, and that these Jews held membership in the Illuminati order which despised and hated the Roman Catholic Church.**⁷⁷²

The Jesuits were established by Ignatius of Loyola. Ignatius of Loyola was the leader of a secret occult organization known as the *Alumbrados* (Spanish for Illuminati).⁷⁷³ On August 15, 1534, Loyola started a sister organization to the *Alumbrados*, which he called the Society of Jesus. It is more commonly known today as the Jesuits. Loyola was arrested by the Dominican order of Catholic inquisitors, who were concerned with his growing influence and power throughout Europe. Because of his influential allies among the principalities of Europe, he was

granted an audience with the pope. Loyola promised the pope his allegiance and agreed to do the bidding of the papacy throughout the world. Pope Paul III formally approved the Jesuits as a Catholic religious order in his 1540 papal bull *Regimini Militantis Ecclesiae*.⁷⁷⁴

The influence of the Jews through the Jesuits in the Roman Catholic Church has been manifested from the beginning in Catholic doctrine. The Council of Trent was an attack on Christianity with anathema after anathema against Christian doctrine that was orchestrated by the Jesuits. The control of the Jews over the Vatican is so complete that Cardinal Joseph Ratzinger (now Pope Benedict XVI), who was the prefect of the Congregation for the Doctrine of the Faith, issued an official doctrine of Catholic faith that accepted the Jewish view that the messiah is yet to come. There is apparently much double talk in the document, as it accepts the Jewish view of a coming messiah without overtly rejecting Jesus. Some have interpreted the document as denying the redemptive role of Jesus. The Catholic Church long ago implicitly denied the redemptive role of Jesus. The document is contained in a small book titled "The Jewish People and the Holy Scriptures in the Christian Bible." It is no surprise that this Jewish/Catholic doctrine was drafted by a Jesuit named Albert Vanhoye.⁷⁷⁵

The Jewish influence over the Roman Catholic institution and its doctrines is manifest in *The Document of the Vatican Commission for Religious Relations with Judaism* § 4, which states: **"We propose, in the future, to remove from the Gospel of St. John the term, 'the Jews' where it is used in a negative sense, and to translate it, 'the enemies of Christ.'"**⁷⁷⁶

At a speech at Hebrew University in Jerusalem, Roman Catholic Cardinal Joseph Bernadine stated:

[T]here is need for . . .theological reflection,

especially with what many consider to be the problematic New Testament's texts ... Retranslation ... and reinterpretation certainly need to be included among the goals we pursue in the effort to eradicate anti-semitism.

[T]he gospel of John ... is generally considered among the most problematic of all New Testament books in its outlook towards Jews and Judaism ... this teaching of John about the Jews, which resulted from the historical conflict between the church and synagogue in the latter part of the first century C.E., can no longer be taught as authentic doctrine or used as catechesis by contemporary Christianity ... Christians today must see that such teachings ... can no longer be regarded as definitive teachings in light of our improved understanding.⁷⁷⁷

Indeed, the Vatican has announced that Christians should not evangelize Jews. On December 11, 2015, *The Guardian* reported:

Catholics should not try to convert Jews and should work with them to fight antisemitism, the Vatican has said, in a major new document that draws the church further away from the strained relations of the past.

Christianity and Judaism are intertwined and God never annulled his covenant with the Jewish people, said the document from the Vatican's commission for religious relations with Jews.

“The church is therefore obliged to view evangelisation to Jews, who believe in the one

God, in a different manner from that to people of other religions and world views,” it said.

“In concrete terms this means that the Catholic church neither conducts nor supports any specific institutional mission work directed towards Jews.” ...

The report also said that while it is only thanks to Christ’s death and resurrection that all people have the chance of salvation, Jews can benefit from this without believing in him. The authors appear to acknowledge that they are effectively squaring a theological circle, however, since how Jews can be saved while not believing in Christ “remains an unfathomable mystery in the salvific plan of God.”⁷⁷⁸

The position of the Vatican toward the Jews is part and parcel of the “Christian” Zionism movement that has also taken hold in many Protestant denominations. For further information on the Jewish influence over both the Catholic church and Protestant churches, read this author’s book, *Bloody Zion*. “Christian” Zionism is directly contrary to the great commission given by Jesus Christ:

Go ye therefore, and teach all nations, baptizing them in the name of the Father, and of the Son, and of the Holy Ghost: Teaching them to observe all things whatsoever I have commanded you: and, lo, I am with you alway, even unto the end of the world. Amen. (Matthew 28:19-20)

The foundational “salvific” doctrine of the Catholic church is unbiblical, and therefore ineffective anyway. The Roman Catholic Church requires faith plus works, whereas the true gospel

only requires faith in Jesus Christ. The Catholic doctrine of faith plus works is the same doctrine of the Jewish gnostics, who argued that obedience to the law was necessary for salvation. Paul, on the other hand, states emphatically that works of the law will not justify a person.

Knowing that a man is not justified by the works of the law, but by the faith of Jesus Christ, even we have believed in Jesus Christ, that we might be justified by the faith of Christ, and not by the works of the law: for by the works of the law shall no flesh be justified. (Galatians 2:16).

Justification is by God's grace through faith alone. "For by grace are ye saved through faith; and that not of yourselves: it is the gift of God: Not of works, lest any man should boast." (Ephesians 2:8-9) For more detailed information on salvation by the Grace of God alone read: *The Anti-Gospel, The Perversion of Christ's Grace Gospel*.⁷⁷⁹

The Vatican states that "how Jews can be saved while not believing in Christ remains an unfathomable mystery in the salvific plan of God." It is a mystery in the same way that all lies are mysterious to those being deceived. God's word makes it clear, however, that there is no salvation for Jew or Gentile aside from Jesus. "Jesus saith unto him, I am the way, the truth, and the life: no man cometh unto the Father, but by me." John 14:6. There is only one way to salvation, and that is by the grace of God through faith in Jesus Christ. Ephesians 2:8. "He that hath the Son hath life; and he that hath not the Son of God hath not life." 1 John 5:12.

There is not a separate means of salvation for the Jew and another for the Gentile. There is only one means of salvation for both. "There is neither Jew nor Greek, there is neither bond nor free, there is neither male nor female: for ye are all one in Christ

Jesus.” Galatians 3:28. All who are saved by grace through faith are Abraham’s spiritual seed (i.e., Christians). “And if ye be Christ's, then are ye Abraham's seed, and heirs according to the promise.” Galatians 3:29.

To refuse to evangelize the Jews is a sin, as it is disobeying a direct command from God to “[g]o ye into all the world, and preach the gospel to every creature.” Mark 16:15. Jesus did not say to preach only to Gentiles; he commanded that the gospel be preached to “every creature;” that includes Jews. Preaching of the gospel is the means God uses to save. Without preaching the word of God, there is no salvation. The preaching must be to both the Jew and Gentile. Jesus is the Lord over all men:

For there is no difference between the Jew and the Greek: for the same Lord over all is rich unto all that call upon him. For whosoever shall call upon the name of the Lord shall be saved. How then shall they call on him in whom they have not believed? and how shall they believe in him of whom they have not heard? and how shall they hear without a preacher? And how shall they preach, except they be sent? as it is written, How beautiful are the feet of them that preach the gospel of peace, and bring glad tidings of good things! But they have not all obeyed the gospel. For Esaias saith, Lord, who hath believed our report? So then **faith cometh by hearing, and hearing by the word of God.** Romans 10:11-17.

G. Richard Fisher succinctly explains the implications of the “Christian” Zionist theology that has infected both the Catholic church and Protestant churches:

If the early Church had taken this view that Jews are saved just by being Jews there would have been no Christians in Jerusalem, Judea or Samaria. When Paul was converted, God would have violated His own plan. Under this view Jesus would not have had Apostles and there would not be a Church today. These logical results seem to escape the purveyors of this form of Christian Zionism, which is neither Christian or Zionist.⁷⁸⁰

The false gospel that Jews can gain entrance into heaven aside from faith in Jesus Christ is the same fallacious Jewish doctrine that God repudiated in the true gospel. Jesus told the Jews that if they truly followed the teachings of Moses, they would accept him as their Messiah, because Moses wrote of him. *See* John 5:39, 46-47. Jesus further told the Jews that “if ye believe not that I am he [Christ], ye shall die in your sins.” John 8:24. Peter told the Jews that salvation only comes through Jesus Christ: “Neither is there salvation in any other; for there is none other name under heaven given among men, whereby we must be saved.” Acts 4:12.

The Vatican is making the same claim for the Jews that Jesus refuted in the gospel of John. Jesus started out by telling the Jews that if they were his disciples they would know the truth and be set free from sin. John 8:31-32. The Jews objected and argued that they were not in bondage and had no need to be set free because they were Abraham’s seed. John 8:33. They argued that by virtue of their status as the physical descendants of Abraham they were in no need of a savior. They claimed that God was their Father by virtue of their physical lineage from Abraham. John 8:39-41. John the Baptist told the Jews from the beginning that their lineage from Abraham would not help them. “And think not to say within yourselves, We have Abraham to our father: for I say unto you, that God is able of these stones to raise up children unto

Abraham.” Matthew 3:9.

Jesus made clear to the Jews that their father was the devil and that if God were truly their Father, they would love him. John 8:42. Those without the Son are also without the Father. The claim by “Christian” charlatans like John Hagee that the Jews have redemption other than by the grace of God through faith in Jesus Christ is impeached by scripture. The Jews deny Jesus is the Christ, and therefore they do not have the Father and are by definition antichrist.

Who is a liar but he that denieth that Jesus is the Christ? He is antichrist, that denieth the Father and the Son. Whosoever denieth the Son, the same hath not the Father: he that acknowledgeth the Son hath the Father also. 1 John 2:23-24.

The “Christian” Zionist dual-covenant theology serves to kill any mission by “Christian” Zionists to spread the gospel to the Jews.⁷⁸¹ Why would Jews come to Christ, if they are told by the “Christian” Zionists that their conversion is irrelevant to their salvation? If they are nationally saved without Jesus Christ anyway, what is the point of believing in Jesus Christ?

The Vatican is not alone in this devilish subterfuge. Steven Paas revealed in his book, *Christian Zionism Examined*, that some “Christian” Zionist missionary groups do not consider their activities in Israel as a mission but simply as “meeting with Israel.”⁷⁸² They do not see the conversion of Jews to Christ as part of their mission. Paas concluded the following about the missionary activities of the “Christian” Zionist *Center for Israel Studies* (CIS): “Their first priority is not leading Jews to Christ, but listening to and learning from Jews and Judaism.”⁷⁸³

What are the teachings of the Jews and Judaism to which Paas refers? The Jewish teachings followed by “Christian”

Zionists are found in the Talmud, which in *Sanhedrin Folio 90a* provides that all Jews (“Israel”) are guaranteed a portion in the world to come.⁷⁸⁴ According to the “Christian” Zionist thought, there is no point in evangelizing the Jews, since they are already guaranteed entrance into heaven without Christ; so say the authoritative Jewish doctrines found in the Talmud.

Jews view “Christian Zionists as “useful idiots,” which is a pejorative phrase used by communists to describe Gentile communist propagandists who do not understand the Jewish goals behind communism. Jews have a secret that they keep from the “Christian” Zionists. According to the previously mentioned tractate in the Talmud (*Sanhedrin Folio 90a*), Christians, who are described as those who read the New Testament (“uncanonical books”), have no portion in the world to come.⁷⁸⁵ In fact, Jews have a particular hatred for Christians. The hatred by Jews against Christians is so intense that Jews are taught to utter a curse when passing a Christian Church, calling on their heathen god (Hashem) to “destroy this house of the proud.”⁷⁸⁶

Elizabeth Dilling explains: “The ‘religious’ Orthodox Jew recites the ‘Eighteen Benedictions,’ or ‘Shemoneh Esreh,’ three times week days, four times on holidays and Sabbaths, the 7th and 12th of which curse the Christians and non-Jews to hell and perdition. Thus, the ‘good Orthodox Jew’ gives us Christians 6 cursings on ordinary days, 8 on ‘specials.’”⁷⁸⁷

The halacha (Jewish religious law) is that it is forbidden for a Jew to engage in any of the religious practices of Christians. The Jews sit smugly meeting with “Christian” Zionists firm in their belief that the Christians are damned to hell, while they are guaranteed entrance into heaven without believing in Jesus Christ. By not evangelizing the Jews, “Christian” Zionists are unwittingly acceding to the laws of the Jews and lending a degree of authenticity to the antichrist Jewish teachings.

The point of church missionary activity should be to spread the gospel of Jesus Christ. However, the “Christian” Zionists go out of their way to avoid doing that very thing. Paas concludes: “Western Christian organisations in Israel often limit themselves to activities of dialogue, study, representation, or support.”⁷⁸⁸

The Vatican implies that evangelizing Jews is a form of antisemitism. On the contrary, to refuse to spread the gospel to the Jews is the purest form of antisemitism. To withhold from the Jews the gospel, which is the only means for their salvation, is unadulterated hatred toward the Jews. The “Christian” Zionists deliberately violate Jesus’ command to “go ye into all the world, and preach the gospel to every creature.” Mark 16:15. The “Christian” Zionists are the very instrument being used by Satan to keep the Jews in spiritual bondage by convincing them that they are part of a unique plan by God simply by virtue of their status as Jews. Despite their claims to love the Jews, Paas concludes that “[f]ailing to communicate Christ-given insights to the Jews is lacking love for them.”⁷⁸⁹

In ancient Palestine the Jews worked hand in hand with the Romans to crucify Christ. Now, the Jews work hand in glove with the Roman Catholic Church in their effort to eradicate Christ’s gospel. The great harlot of Babylon in Revelation 17:5 has Mystery written upon her forehead. She is called Babylon because she is Babylonian. She is a mystery because she is masquerading as “the” Christian religion. Christian labels have been applied to Babylonian paganism to come up with the mystery religion we know as the Roman Catholic Church. Both the Talmudic Jews and the Vatican share that common Babylonian root. The Jesuits nurtured the Babylonian Cabalism in Roman Catholic doctrine. The similarities between the imperious whorish woman in Ezekiel 16:14-40 and the Mother of Harlots in Revelation 17:5 are unmistakable. They are one and the same. Roman Catholicism is an esoteric version of Babylonian Judaism.

The Roman Church appears gentle to the uninitiated, but it is Jewish to its core. Orthodox Judaism appears to the uninitiated to be the Old Testament theology, but it is actually Babylonian to its core.

The *Extreme Oath of the Jesuits*, which is given to a Jesuit Priest when he is elevated to a position of command, contains the following provisions:

I . . . declare and swear that his holiness, the Pope, is Christ's Vice-regent, and is the true and only head of the Catholic or Universal Church throughout the earth.

* * *

Therefore, to the utmost of my power, I shall and will defend this doctrine and his Holiness' right and customs against all usurpers of the heretical or Protestant authority, whatever especially the Lutheran Church of Germany, Holland, Denmark, Sweden, and Norway, and the now pretended authority of the Church of England and Scotland, the branches of the same, now where I do now renounce and disown any allegiance as due to any heretical king, prince or state named Protestant or Liberals, or obedience to any of their laws, magistrates or officers.

* * *

That I will go to any part of the world, whatsoever, without murmuring and will be submissive in all things whatsoever communicated to me I do further promise and declare, that I will, when opportunity

presents, make and wage relentless war, secretly or openly, against all heretics, Protestants and Liberals, as I am directed to do to extirpate and exterminate them from the face of the whole earth, and that I will spare neither sex, age, nor condition, and that I will hang, waste, boil, flay, strangle, and bury alive these infamous heretics; rip up the stomachs and wombs of their women and crush their infants' heads against the wall, in order to annihilate forever their execrable race.

That when the same cannot be done openly, I will secretly use the poison cup, the strangulation cord, the steel of the poinard, or the leaden bullet, regardless of the honor, rank, dignity or authority of the person or persons whatsoever may be their condition in life, either public or private, as I at any time may be directed so to do by any agent of the pope or superior of the brotherhood of the holy faith of the Society of Jesus.⁷⁹⁰

The Jesuits are the secret army of the Roman church; they are often referred to as the "pope's militia." In fact, the leader of the Jesuits is called the "Jesuit General." He is unlike any other leader of a Catholic order, because the Jesuit General is independent of the Catholic Bishops and Cardinals; he answers directly to the Pope. Because of the power and influence of the Jesuit General, he is known as the "Black Pope." The Jesuit General has the purported authority to absolve persons of the sins of bigamy, murder, or any harm done to others as long as the matter is not publicly known and the cause of a scandal.⁷⁹¹ Pope Gregory XII gave the Jesuits the authority to deal in commerce and banking, which has made the order quite wealthy.⁷⁹² The popes have threatened princes, kings, and anyone else who interferes with the Jesuits with excommunication (*Latae Sententiae*).⁷⁹³ In one of the most authoritative works on the Jesuits, J. Huber,

professor of Catholic theology wrote: “Here is a proven fact: the Constitutions [of the Jesuits] repeat five hundred times that one must see Christ in the person of the [Jesuit] General.”⁷⁹⁴

If the Jesuits are a Crypto-Jewish order that hates the Roman Catholic church, as alleged by John Torell, why would it become a priestly order within that church and become its greatest defender with extreme oaths of obedience to the pope? Because, the Roman church offers the Jews an ideal cover from which to wage war against Christianity. This is evidenced by the fact that the Jesuits virtually controlled the Council of Trent, which produced anathema after anathema against bible believing Christians and fundamental Christian doctrine. This same Jesuit organization, however, initially opposed the inquisition.⁷⁹⁵ Why? Because the inquisition, in part, was initiated to root out crypto-Jewry inside the Catholic church. Of course, an organization founded and controlled by crypto-Jews would oppose a strategy that would expose its own Jewish core. Once the Jesuits gained control of the papacy they took a more favorable view of the inquisition. They became the pope’s militia controlling the organs of the inquisition in a spiritual battle against Protestants.

The hierarchy of Orthodox Jews hate Gentiles; ostensibly gentile organizations like the Roman church offer an ideal front from which to strike against the hated Christians. That is why God refers to the great harlot of Babylon as “MYSTERY.” The Roman church appears to the world to be a gentile religious organization, yet it is to its core Jewish. As long at the Roman church does the bidding of the Jews, they will defend it. Once the Roman church is no longer useful it will shed it like a snake sheds its old skin.

It seems that the Jews have the destruction of the Roman church all planned out. The following is a passage from the THE PROTOCOLS OF THE LEARNED ELDERS OF ZION that seem to foretell the destruction of the Vatican by the nations of the world.

When the time comes finally to destroy the papal court the finger of an invisible hand will point the nations towards this court. When, however, the nations fling themselves upon it, we shall come forward in the guise of its defenders as if to save excessive bloodshed. By this diversion we shall penetrate to its very bowels and be sure we shall never come out again until we have gnawed through the entire strength of this place.⁷⁹⁶

That is very similar to the prophecy found in the book of Revelation.

And the ten horns which thou sawest upon the beast, **these shall hate the whore, and shall make her desolate and naked, and shall eat her flesh, and burn her with fire.** For God hath put in their hearts to fulfil his will, and to agree, and give their kingdom unto the beast, until the words of God shall be fulfilled. And the woman which thou sawest is that great city, which reigneth over the kings of the earth. (Revelation 17:16-18)

The horns of the beast are ten kings on the beast that is being ridden by the great harlot who sits on seven mountains (the Vatican). Revelation 17. The PROTOCOLS have set forth the planned destruction of the Vatican. The PROTOCOLS seem also to have provided for the entrance of the antichrist. "THE KING OF THE JEWS WILL BE THE REAL POPE OF THE UNIVERSE, THE PATRIARCH OF THE INTERNATIONAL CHURCH."⁷⁹⁷

In fact, the Jesuits, the great defenders of the Catholic faith, have actually exercised their power to undermine the authority of the church and bring it to its knees. The reason the

Jesuits retaliated against the Catholic church was that the Jesuits were at one time dissolved as a Catholic order because of their subversive conduct. The subversion of the European nations by the Jesuits became so great that an immense amount of military and political pressure was brought against the pope by the European nations. Finally, Pope Clement XIII decided on the 3rd of February 1769 to dissolve the Jesuits. While Jesuits are under an oath of allegiance to the pope, that oath is secondary to their extreme oath of allegiance to the Jesuit General:

I do further promise and declare, that I will have no opinion or will of my own, or any mental reservation whatever, even as a corpse or cadaver [perinde ac cadaver] but unhesitatingly, obey each and every command that I may receive from my superiors in the Militia of the Pope and Jesus Christ.⁷⁹⁸

The night before Pope Clement XIII was to execute the dissolution, however, he suddenly fell ill and died. Prior to his death he cried out "I am dying . . . It is a very dangerous thing to attack the Jesuits."⁷⁹⁹ His successor, Pope Clement XIV, was also put under tremendous political pressure to dissolve the Jesuits, but he resisted doing so for three years until the political tension finally forced his hand. Pope Clement XIV issued the papal brief of dissolution, *Dominus ac Redemptor*, on August 16, 1773.⁸⁰⁰ Pope Clement XIV knew the significance of such an act to the papacy; he exclaimed: "I have cut off my right hand."⁸⁰¹ In addition, Pope Clement XIV knew that by signing the brief dissolving the Jesuits he was signing his own death warrant. Soon after signing the brief the letters I.S.S.S.V. appeared on the palace walls in the Vatican.⁸⁰² Pope Clement XIV knew what it meant and explained that it stood for *In Settembre, Sara Sede Vacante*. Which translated means "in September, the See will be vacant (the pope will be dead)."⁸⁰³ Pope Clement XIV was poisoned and died on September 22, 1774.⁸⁰⁴

Interestingly, it was just three years after Pope Clement XIV's suppression of the Jesuits that the subversive organization the "Illuminati" was purportedly founded by a trained Jesuit named Adam Weishaupt in 1776.⁸⁰⁵ Weishaupt was a Jew and a professor of canon law at Ingolstadt University, which was a Jesuit University and the center of the Jesuit counter-reformation.⁸⁰⁶ Alberto Rivera, a former Jesuit priest, stated that the occult Illuminati organization was not founded by Weishaupt, as many believe, but in fact was established long before Weishaupt. The Illuminati is in fact a reincarnation of the ancient *Alumbrados*, whose one time leader was Ignatius of Loyola, the founder of the Jesuits.⁸⁰⁷ The Illuminati was established by Lorenzo Ricco, the Jesuit General, in 1776, who used his disciple, Adam Weishaupt, as the front man for the new organization (which was really not new at all).⁸⁰⁸ The Jesuits, having just been suppressed by the pope in 1773, found it necessary to establish the Illuminati, which was an alliance between the Jesuits and the very powerful Ashkenazi Jewish Banking House of Rothschild. The purpose of Weishaupt initially was to avenge the papal suppression of the Jesuits by rooting out all religion and overturning the governments of the world, bringing them under a single world government, controlled of course by the Illuminati, under the authority of their god. That world government is commonly referred to by the Illuminati as the "New World Order." The god of the Illuminati is Satan.⁸⁰⁹

Eric Jon Phelps in his book, *The Vatican Assassins*, explains:

These 41 years [between their suppression in 1773 by Pope Clement XIV and their reestablishment by Pope Pius VII in 1814] were absolutely golden for the Society of Jesus. For the Sons of Loyola punished all their enemies, including the Dominican priests, perfected the

inner workings between themselves and Freemasonry, creating alliance between the house of Rothschild in establishing the illuminati; punished and absorbed the Knights of Malta They used the Orthodox Catherine of Russia and a Lutheran Frederick of Prussia to conquer and divide Poland, rendering the pope's Bull of Suppression of no effect in that Roman Catholic land. They caused the French Revolution, beheaded a Bourbon King and a Hapsburg Queen as punishment for being expelled from France and Austria. With Napoleon, the Freemason, they drove the Bourbons from their throne in Spain and the Braganzas from their throne in Portugal. They even attempted to take Palestine from the Moslems like the Crusaders of old.⁸¹⁰

The company's most important victories were both religious and political. They deeply penetrated the Russian Orthodox Church and Germany's Lutheran Church, its Tubingen University specifically. Politically, they took control of the crown and the Bank of England. For this reason England, with Viscount Palmerston, would never go to war with France again, it would conduct the Pope's opium wars against people of China (just like the company, with its CIA and Mafia Commission is presently conducting a massive drug trade against the "heretic and liberal" people of the American Empire) . . . The Jesuits also captured the Papacy with the Vatican; along with its landed church properties the world over, and for this reason the Papal Caesar, occupying Satan's sacred office of the Papacy, would never suppress the Society of Jesus *ever again!*⁸¹¹

The secret Illuminati organization was the hidden guiding hand behind the brutal French Revolution of 1787, during which 300,000 people were massacred in a godless orgy of violence.⁸¹² The rage by the Jesuits and their reconstituted Illuminati culminated in 1798, with the capture of the pope himself. Napoleon's General Berthier invaded Rome, took the Pope Pius VI prisoner, and held him until his death.

The Roman Catholic church had learned its lesson. On August 7, 1814, the Jesuits were restored as a Catholic order by Pope Pius VII.⁸¹³ John Adams wrote to Thomas Jefferson in 1816 "I am not happy about the rebirth of the Jesuits. . . . Swarms of them will present themselves under more disguises ever taken by even a chief of the Bohemians, as printers, writers, publishers, school teachers, etc. If ever an association of people deserved eternal damnation, on this earth and in hell, it is the Society of Loyola. Yet, with our system of religious liberty, we can but offer them a refuge."⁸¹⁴ Thomas Jefferson answered Adams: "Like you, I object to the Jesuits' reestablishment which makes light give way to darkness."⁸¹⁵

In 1835, Samuel Morse, the great inventor of the telegraph, echoed the concerns of Jefferson and Adams; he described the Jesuits and their threat to the United States as follows:

And do Americans need to be told what *Jesuits* are? If any are ignorant, let them inform themselves of their history without delay: no time is to be lost: their workings are before you in every day's events: they are a *secret* society, a sort of Masonic order, with superadded features of most revolting odiousness and a thousand times more dangerous. They are not confined to one class of society; they are not merely priests,

or priests of one religious creed, they are merchants, and lawyers, and editors, and men of any profession, and no profession, having no outward badge (in this country,) by which to be recognised; they are about in all your society. They can assume any character that of angels of light, or ministers of darkness, to accomplish their one great end, the *service* upon which they are sworn to *start at any moment, in any direction*, and for any service, commanded by the general of their order, bound to no family, community, or country, by the ordinary ties which bind men; and *sold for life* to the cause of the Roman Pontiff.⁸¹⁶

The concerns of Morse, Adams, and Jefferson were justified; once being reestablished as a Catholic order the Jesuits did not miss a beat; during the 19th century they fomented revolutions throughout the world, attempting to bring to power oppressive despots whom they would then control. They were at one time or another expelled from Russia (1820), Belgium, Portugal (1834), the Italian states (1859), Spain (three times-1820, 1835, and 1868), Germany (1872), Guatemala (1872), Mexico (1873), Brazil (1874), Ecuador (1875), Colombia (1875), Costa Rica (1884), and France (twice-1880 and 1901).⁸¹⁷ They caused the Swiss Civil war in 1847. As a result they were banished from Switzerland in 1848.⁸¹⁸ Up until the year 2000, the Swiss Constitution (article 51) forbade the Jesuits from engaging in any cultural or educational activity in Switzerland.⁸¹⁹ In the year 2000 Switzerland ratified a new constitution, in which article 51 was removed. Those are just a sampling of the over 70 countries from which the Jesuits have been expelled for conducting subversive activities. The Jesuit subversion has continued to modern times, causing the Jesuits to be expelled from Haiti in 1964 and Burma in 1966.⁸²⁰ To this day they are instigating communist revolutions in South America. The Jesuits' new brand of South American

communism is known as “Liberation Theology.”

Jesuits have a long and sordid history of distorting moral obligations and practicing and advocating situational ethics. For example, God commands without exception that “Thou shalt not bear false witness against thy neighbor.” Exodus 20:16. The Jesuits, on the other hand, permit the use of ambiguous terms to mislead a judge or outright lying under oath if the witness makes a mental reservation.⁸²¹ The Jesuits teach that if a young girl is pregnant, she may obtain an abortion if the pregnancy would bring dishonor to her or a member of the clergy.⁸²² They do not stop there; another Jesuit maxim states: “If a Father, yielding to temptation, abuses a woman and she publicises what has happened, and, because of it, dishonours him, this same Father can kill her to avoid disgrace.”⁸²³ That is not the only cause that is justification for murder. The Jesuits further teach that “[a] monk or a priest is allowed to kill those who are ready to slander him or his community.”⁸²⁴

Immorality is not unique to the Jesuit order only. The doctrines of the Catholic Church allow for all sorts of situational ethics. Thomas Aquinas, the most influential source of economic and theological doctrines for the Catholic Church, stated that it is lawful and not a sin for a man to steal another’s property in order to fulfill a basic need. Aquinas’ view was that all goods are community goods and therefore it is not a sin to take another’s property when you need it.⁸²⁵ That is in fact the official position of the Roman church today as expressed by the Second Vatican Council. “If one is in extreme necessity he has the right to procure for himself what he needs out of the riches of others.”⁸²⁶

What is the authority for this ethic? It is found in the Talmud. In *Baba Bathra 54b* it states: “The property of a heathen is on the same footing as desert land; whoever first occupies it acquires ownership.”⁸²⁷ Compare that to the eighth commandment of God: “Thou shalt not steal.” Exodus 20:15.

Furthermore, in *Baba Kamma 113b* it states that if one finds lost property it must be returned if the owner is a Jew; however if the owner is a gentile it can be kept. “It is to your brother that you make restoration, but you need not make restoration to a heathen.”⁸²⁸

The Jesuits are zealous persecutors of Christians or anyone whom they view as an enemy of the Vatican. Jesuits take a solemn oath to destroy Protestant Christians and destroy any government that offers protection to Protestant Christians.⁸²⁹ They are the natural enemies of liberty, their whole system is based on thoughtless, ruthless, blind obedience. Ignatius himself writing to his Jesuits in Portugal said: “We must see black as white if the church says so.”⁸³⁰ Jesuits are the subversive ambassadors of the Catholic Church, bringing chaos and ruin to all nations they infiltrate. They believe that “[t]he Catholic Church has the right and duty to kill heretics because it is by fire and sword that heresy can be extirpated. . . . Repentance cannot be allowed to save them, just as repentance is not allowed to save civil criminals; for the highest good of the church is the unity of the faith, and this cannot be preserved unless heretics are put to death.”⁸³¹

Alberto Rivera, a former Jesuit Priest, was saved by the grace of God and came out of the Jesuit priesthood. The Jesuits made numerous attempts to kill him before he could reveal the secrets of the Jesuits. He survived the attempts on his life and exposed much about sinister methods and motives of the Jesuits.

Franz Wernz, the Jesuit General from 1906-1915, stated that “[t]he Church can condemn heretics to death, for any rights they have are only through our tolerance, and these rights are apparent not real”⁸³² That view of heretics having no rights is very similar to the philosophy of the Jewish Talmud. Sanhedrin 57b provides that if a heathen robs another or a Jew the property must be returned. If, however, a Jew robs a heathen, the property does not have to be returned to the heathen.⁸³³ That section of the

Talmud also states that if a heathen murders another heathen or a Jew, the heathen should suffer the death penalty. If, however, a Jew kills a heathen “there is no death penalty.”⁸³⁴ For example, Jewish Rabbi Moseh Levinger was sentenced to a mere 5 months in jail by an Israeli court for the unprovoked cold-blooded murder in September 1988 of a Palestinian shopkeeper, Hassan Salah.⁸³⁵ Prior to entering prison, Rabbi Levinger was feted at a party by Israeli President Chaim Herzog and Israeli Army General Yitzhak Mordechai.⁸³⁶ Rabbi Levinger was released from prison after only serving three months.⁸³⁷ Baba Kamma 38a expressly states that Canaanites are “outside the protection of the civil law of Israel.” Thus a Canaanite has no remedy against a Jew whose ox gores the Canaanite’s ox, but if a Canaanite’s ox gores a Jew’s ox, the Canaanite shall pay in full the damages.

Professor Israel Shahak explains:

According to the Jewish religion, the murder of a Jew is a capital offense and one of the three most heinous sins (the other two being idolatry and adultery). Jewish religious courts and secular authorities are commanded to punish, even beyond the limits of the ordinary administration of justice, anyone guilty of murdering a Jew. A Jew who indirectly causes the death of another Jew is, however, only guilty of what talmudic law calls a sin against the 'laws of Heaven', to be punished by God rather than by man.

When the victim is a Gentile, the position is quite different. A Jew who murders a Gentile is guilty only of a sin against the laws of Heaven, not punishable by a court.⁸³⁸ To cause indirectly the death of a Gentile is no sin at all.⁸³⁹

Thus, one of the two most important

commentators on the Shulhan Arukh explain that when it comes to a Gentile, 'one must not lift one's hand to harm him, but one may harm him indirectly, for instance by removing a ladder after he had fallen into a crevice .., there is no prohibition here, because it was not done directly.'⁸⁴⁰ He points out, however, that an act leading indirectly to a Gentile's death is forbidden if it may cause the spread of hostility towards Jews.

A Gentile murderer who happens to be under Jewish jurisdiction must be executed whether the victim was Jewish or not. However, if the victim was Gentile and the murderer converts to Judaism, he is not punished.⁸⁴¹

The animus by Jews toward Gentiles includes a prohibition against giving medical treatment to Gentiles. Israel Shahak explains:

According to the Halakhah, the duty to save the life of a fellow Jew is paramount.⁸⁴² It supersedes all other religious obligations and interdictions, excepting only the prohibitions against the three most heinous sins of adultery (including incest), murder and idolatry.

As for Gentiles, the basic talmudic principle is that their lives must not be saved, although it is also forbidden to murder them outright.⁸⁴³ The Talmud itself expresses this in the maxim 'Gentiles are neither to be lifted [out of a well] nor hauled down [into it]'. Maimonides⁸⁴⁴ explains:

"As for Gentiles with whom we are not at war ... their death must not be caused, but it is forbidden to save them if they are at the point of death; if, for example, one of them is seen falling into the sea, he should not be rescued, for it is written: 'neither shalt thou stand against the blood of thy fellow'⁸⁴⁵ - but [a Gentile] is not thy fellow."

In particular, a Jewish doctor must not treat a Gentile patient. Maimonides - himself an illustrious physician - is quite explicit on this; in another passage⁸⁴⁶ he repeats the distinction between 'thy fellow' and a Gentile, and concludes: 'and from this learn ye, that it is forbidden to heal a Gentile even for payment...'

However, the refusal of a Jew - particularly a Jewish doctor - to save the life of a Gentile may, if it becomes known, antagonize powerful Gentiles and so put Jews in danger. Where such danger exists, the obligation to avert it supersedes the ban on helping the Gentile. Thus Maimonides continues: ' ... but if you fear him or his hostility, cure him for payment, though you are forbidden to do so without payment.' In fact, Maimonides himself was Saladin's personal physician. His insistence on demanding payment - presumably in order to make sure that the act is not one of human charity but an unavoidable duty - is however not absolute. For in another passage he allows [a] Gentile whose hostility is feared to be treated 'even gratis, if it is unavoidable'.

The whole doctrine - the ban on saving a Gentile's life or healing him, and the suspension of this ban in cases where there is fear of hostility

- is repeated (virtually verbatim) by other major authorities, including the 14th century Arba'ah Turim and Karo's Beyt Yosef and Shulhan 'Arukh.⁸⁴⁷ Beyt Yosef adds, quoting Maimonides: 'And it is permissible to try out a drug on a heathen, if this serves a purpose'; and this is repeated also by the famous R. Moses Isserles.

The consensus of halakhic authorities is that the term 'Gentiles' in the above doctrine refers to all non-Jews.⁸⁴⁸

That Jewish attitude toward non-Jews is the same attitude the crypto-Jewish Jesuits have toward Christians. Jesuit priests are subjected to certain "spiritual exercises" which were first devised by Ignatius Loyola. During the spiritual exercises the subject becomes possessed and controlled by a devil.

We imbue into him spiritual forces which he would find very difficult to eliminate later, forces more lasting than all the best principles and doctrines; these forces can come up again to the surface, sometimes after years of not even mentioning them, and become so imperative that the will finds itself unable to oppose any obstacle, and has to follow their irresistible impulse.⁸⁴⁹

Between 1569 and 1605 the Jesuits orchestrated no less than eleven plots against Protestant England, which involved invasion, rebellion, and assassination. Each is known by the leader of the treachery: Ridolfi, Sanders, Gregory XIII, Campion, Parsons, Duke of Guise, Allen, Throgmorten, Parry, Babington, Sixtus V, Philip II of Spain, Yorke, Walpole, Southwell, and Guy Fawkes.⁸⁵⁰

In the 1586 “Babington plot” the Jesuits along with other Catholics planned to kill Protestant Queen Elizabeth I, place Catholic Mary Stuart, Queen of Scots on the throne of England and bring England under subjection to the Pope of Rome. That plot was discovered and Mary was executed for her troubles.⁸⁵¹

After the failed Babington plot, the Pope, in league with Philip II of Spain, planned to invade England and bring it under papal control. In 1588 Spain brought the 136 ship Spanish Armada against England. The Sovereign God of the Universe whipped up a freak storm which devastated the Armada and allowed England with only 30 ships to defeat Spain after an eight hour sea battle.⁸⁵²

On November 5, 1605 Jesuit led Roman Catholic conspirators planned to kill King James I and the entire English Parliament by blowing up the House of Lords. They placed 20 barrels of gunpowder under the House of Lords. The plan was to blow up the house of Lords when the Lords, Commons, and King were all assembled on November 5, 1605 for the opening of Parliament.⁸⁵³ The plot, however, was discovered and the conspirators were captured. To this day that event is simply referred to as the “Gunpowder Plot.”⁸⁵⁴ November 5 is a national holiday in England, commemorating the Catholic conspiracy in the Gunpowder Plot. The holiday is called Guy Fawkes Day; Guy Fawkes was one of the Gunpowder Plot conspirators.⁸⁵⁵

The Jesuit subversion of nations has caused 56 countries to ban the Jesuits, most of whom have since lifted the bans. In 1759 the Jesuits were banned throughout the Portuguese Empire.⁸⁵⁶ In 1764 the Jesuits were outlawed in France, and in 1767 they were banned from Spain.⁸⁵⁷ On April 6, 1762 the French Parliament issued the following “statement of arrest” (indictment):

The said Institute [Jesuits] is inadmissible in any

civilised State, as its nature is hostile to all spiritual and temporal authority; it seeks to introduce into the Church and States, under the plausible veil of a religious Institute, not an Order truly desirous to spread evangelical perfection, but rather a political body working untiringly at usurping all authority, by all kinds of indirect, secret, and devious means. . . . [The Jesuits' doctrine is] perverse, a destroyer of all religious and honest principles, insulting to Christian morals, pernicious to civil society, hostile to the rights of the nation, the royal power, and even the security of the sovereigns and obedience of their subjects; suitable to stir up the greatest disturbances in the States, conceive and maintain the worst kind of corruption in men's hearts.⁸⁵⁸

All nations should learn from the experience of Protestant England and understand the threat that Rome and the Jesuits pose to any free country. The Roman Catholic Church uses religious superstition to usurp the authority and undermine the independence of any state. King Henry VIII cast off the yoke of Rome and declared that he was to be the head of the church in England.

In May 1538, the pope sought his revenge for the separation of the Church of England from Rome; the pope excommunicated all in Ireland who recognized the supremacy of the King of England or any ecclesiastical or civil power greater than that of the Roman Catholic Church. The events are recounted in the classic *Foxe's Book of Martyrs*:

A short time after this, the pope sent over to Ireland (directed to the archbishop of Armagh and his clergy) a bull of excommunication against all who had, or should own the king's

supremacy within the Irish nation; denouncing a curse on all of them, and theirs, who should not, within forty days, acknowledge to their confessors, that they had done amiss in so doing.

Archbishop Browne gave notice of this in a letter dated, Dublin, May, 1538. Part of the form of confession, or vow, sent over to these Irish papists, ran as follows: "I do further declare him or her, father or mother, brother or sister, son or daughter, husband or wife, uncle or aunt, nephew or niece, kinsman or kinswoman, master or mistress, and all others, nearest or dearest relations, friend or acquaintance whatsoever, accursed, that either do or shall hold, for the time to come, any ecclesiastical or civil power above the authority of the Mother Church; or that do or shall obey, for the time to come, any of her, the Mother of Churches' opposers or enemies, or contrary to the same, of which I have here sworn unto: so God, the Blessed Virgin, St. Peter, St. Paul, and the Holy Evangelists, help me," etc. is an exact agreement with the doctrines promulgated by the Councils of Lateran and Constance, which expressly declare that no favor should be shown to heretics, nor faith kept with them; that they ought to be excommunicated and condemned, and their estates confiscated, and that princes are obliged, by a solemn oath, to root them out of their respective dominions.⁸⁵⁹

The political and religious attacks against Protestant England by Rome continued up to and beyond 1641; in 1641 the beast of Rome planned a murderous insurrection in Ireland. The objective of the barbarous conspiracy was to murder all Protestants in Ireland, without exception. In this instance, as in many others,

we find the Jesuits leading the murderous and maniacal charge. The Jesuits placed their hellish imprimatur on the massacre by beginning it on the feast day of their founder, Ignatius of Loyola. When the dust finally settled on the genocide, Rome had exterminated 150,000 innocent men, women, and children. This massacre illustrates the danger of a Roman Catholic majority in any country. No matter who seems to control the political reigns, when the lawful government is at odds with Rome there will be hell to pay. Rome is a master at mass insurrection through the incitation of base barbarians who have sold their soul to the superstition of the Roman Cult.

The Irish genocide was planned and orchestrated from the Vatican. It was executed through the leadership of the Jesuits and the other priests of Rome. He who has eyes let him see through the pious facade of Rome. He who has understanding let him understand the danger posed by Rome and the Jesuits. The Roman Catholic Church never changes.

King Henry VIII's error is all too obvious, for there is only one head of God's church and that is Jesus Christ. The pope was incensed at the insolence of King Henry. The pope, however, was not angry because the king blasphemously claimed the authority of Christ as head of the church, but because the king had replaced him, the supreme pontiff of Rome, as the head of the church. The King of England was politically too strong for the pope to do anything to change the situation in England (though he tried); consequently the monarch of England to this day is the head of the Church of England (known as the Anglican or Episcopal Church). The Episcopal church is one of the harlot daughters of the Roman Catholic mother of harlots. *See Revelation 17:5.* For the most part, the leadership of the Episcopal Church are not Christian; they are rather the proverbial rejected tares growing in Christ's wheat field.

The Jesuits are all over the godless philosophies of the

Jews that are being passed off as science. Not only do we have Jesuit Priest Lemaitre taking credit for the Rabbi Nachmanides' big bang theory, but we have Jesuit Priest Pierre Teilhard de Chardin at the forefront of the religious belief of evolution masquerading as "science." Indeed, de Chardin was caught orchestrating the Piltdown Man fraud. It was the Piltdown Man fraud that did the most to embed the evolutionary religion in the minds of scientists and the curricula of schools. In 1913 Piltdown Man was announced to the world as clear evidence of a transition between man and ape. For 40 years it was touted as evidence in support of evolution, until in 1953 it was exposed as a forgery.

It was later discovered that the skull of Piltdown Man was from a modern man and that the jawbone and teeth were from an orangutan. The teeth in the jaw had been filed down to make them look human. The bones and teeth had been chemically treated to give them the appearance of being prehistoric. The bones were then planted at the burial site in which they were found. There is a strong belief among those who have investigated the matter that the noted Jesuit Priest Pierre Teilhard de Chardin was instrumental in perpetrating that hoax. The scientist who helped unmask the forgery, Dr. Kenneth Oakley, formerly of the British Museum, said that a letter written to him by Teilhard in 1954 had given him "strong indications that Teilhard was in collusion with Charles Dawson," in committing the Piltdown Man hoax.⁸⁶⁰

The famous evolutionist Theodosius Dobzhansky (The American Biology Teacher, volume 35, number 3, March 1973, page 129) quoted Pierre Teilhard de Chardin as saying: "Evolution is a light which illuminates all facts, a trajectory which all lines of thought must follow."⁸⁶¹ That is not a scientific approach, it is a religious philosophy; it is a rejection of Christ. Jesus is our light that we must follow, not evolution. "Then spake Jesus again unto them, saying, I am the light of the world: he that followeth me shall not walk in darkness, but shall have the light of life." (John 8:12)

Despite this and other frauds among evolutionists, in 1996, Pope John Paul II announced that evolution is compatible with Christian beliefs. While evolution is compatible with Catholicism and Judaism, evolution is not compatible with Christianity; evolution is irreconcilable with and antagonistic to Christianity.

In 1998, the pope toned down his position, by announcing that evolution alone cannot account for human existence. He, however, did not repudiate his pro-evolutionary position. God's word describes Adam as being "**made** a living soul." The new corrupt bible versions follow the evolutionary philosophy of the world.. For example, the New International Version (NIV) changes God's word to say that Adam "**became** a living being." In the NIV man was not created, but instead just "became." This evolutionary slant fits in nicely with the Roman Catholic and Judaic teachings.

AV (KJV)

And so it is written, The first man Adam **was made** a living soul. (1 Corinthians 15:45 AV (KJV))

NIV

So it is written: "The first man Adam **became** a living being." (1 Corinthians 15:45 NIV)

The new bible versions being promoted by the Catholic Church are counterfeits. God's true word in the English language is the Authorized (King James) Version of the bible. The Jesuits and the Roman Catholic Church could not stop the propagation of God's word, so they happened upon a strategy to lure people away from God's true word by presenting them with counterfeit bibles, such as the NIV. The fake bibles are part and parcel of the Roman Catholic animus toward God's true word found in the Authorized (King James) Version of the bible. Dr. Ian Paisley, a Protestant minister and Member of the British Parliament from Northern

Ireland, Member of the European Parliament, and founder of the Democratic Unionist Party, exposed the Jesuit and Roman Catholic view of the bible. Paisley uncovered an oath taken by Protestants during the dark ages upon their conversion into the Roman Catholic Church.

Bishop Wordsworth, an eminent Church of England divine uncovers the secrecy of the Jesuits. In the exposure of a document, used by them in their early days to compel Protestants to submit to Mother Church. *Roman Catholic Confession Publicly Prescribed and Proposed to Protestants on their Admission to the Roman Catholic Church.*

“We confess that we've been brought from heresy, to the true saving Roman Catholic faith, by the singular care of our supreme governors, and by the diligence and aid of our masters the fathers of the Order of Jesuits. And we desire to certify this by our vows to the world at large. We confess that whatever new thing the pope ordains, whether it be in Scripture or not in Scripture and whatever he commands is divine and therefore ought to be held by lay people in greater esteem than the precepts of the living God. We confess that the reading of holy scripture is the origin of heresy and schism and the source of blasphemy. We confess that holy scripture is imperfect and a dead letter until it is explained by the Supreme Pontiff, and allowed by him to be read by the laity. We confess and assert, that the Pope as our most holy father, is to be obeyed in all things, without any exception and that such heretics as contravene his orders, are not only to be burnt but to be delivered both body and soul to Hell.”⁸⁶²

Evolution is antithetical to the creation account found in the bible. God has kept his promise to preserve his word. The Catholic Church, therefore, opted for the only strategy left open. It has presented the world with phoney bibles that allow for evolution. The pope's pro-evolutionary views were simply confirming the tradition of his spiritual ancestors, the Jews. For example, Moses ben Maimon (a/k/a Maimonides), the most revered and authoritative rabbi in Judaism, had a decidedly evolutionary view. In fact, he put a racial spin on the Talmudic passage at Baba Mezia 114b, which states that only Jews are men, Gentiles ("heathen") are not men. Maimonides lowered blacks within the gentile category to a status just above a monkey.⁸⁶³ Maimonides stated:

[T]he Negroes found in the remote South, and those who resemble them from among them that are with us in these climes. The status of those is like that of irrational animals. To my mind they do not have the rank of men, but have among the beings a rank lower than the rank of man but higher than the rank of apes. For they have the external shape and lineaments of a man and a faculty of discernment that is superior to that of the apes.⁸⁶⁴

It seems that Maimonides (1135-1204 A.D.) framed the foundational principles for the theory of evolution long before Charles Darwin. The theory of evolution is founded upon the same racism expressed by Maimonides. Darwin was a racist who believed that Blacks were closer to apes in the evolutionary process. In fact, the liberal humanists don't want the general public to know that the full title of Darwin's seminal 1859 book on evolution was: "THE ORIGIN OF SPECIES BY MEANS OF NATURAL SELECTION OR THE PRESERVATION OF FAVORED RACES IN THE STRUGGLE FOR LIFE."

Darwin elaborated on his racist views as follows: "At some future period, not very distant as measured by centuries, the civilized races of man will almost certainly exterminate and replace the savage races throughout the world. At the same time the anthromorphous apes will no doubt be exterminated. The break between man and his nearest allies will be wider, for it will intervene between man in a more civilized state, as we may hope, even that the Caucasian and some ape as low as a baboon instead of as now between the Negro or Australian and the gorilla."⁸⁶⁵ That is very close to the racism expressed by Maimonides.

There seems to be some division among Jews, at least in public discourse, over the legitimacy of evolution to explain man's being. Many Jews reject creation and accept evolution, while others take the view that there is a god who did create man. Some in the creation camp accept a literal six days of creation, while others take the view that a god did it gradually through evolution. Rabbi Shraga Simmons expresses a view that attempts to reconcile the creation account in Genesis and the theory of evolution. This attempt to reconcile the irreconcilable tries to salvage the legitimacy of the theory of evolution in the face of the contrary biblical account:

Rabbi Shimshon Rafael Hirsch (19th century Germany) further explains that each "Day" represents a specific stage of creation - i.e. a mingling of raw materials and bursts of dramatic new development. As you go through the Torah's account, you see described a gradual process from simple to more complex organisms - first a mass of swirling gasses, then water, then the emergence of dry land, followed by plants, fish, birds, animals, and finally, human beings. This pattern may be similar to the evolutionary process proposed by science.⁸⁶⁶

The problem with Rabbis Simmons and Hirsch is that they have taken what God has stated in the bible and proposed that God did not mean what he said. The bible does not offer proof of a “gradual process from simple to more complex organisms” as theorized by Rabbi Simmons. The bible presents creation of the heavens and the earth out of nothing within six literal days.

The theory of evolution is not only contrary to God’s word, but it is not based on true science; its origins are from heathen religious beliefs. According to the established laws of science, evolution is an impossibility. The second law of thermodynamics, also known as the law of entropy, is that all matter, living or inanimate, goes from a state of order to disorder. The theory of evolution reverses that sequence and states that over time organisms go from a state of disorder to order; from the simple to the complex.

To illustrate the conflict between evolution and the laws of science, suppose one were to write each letter of one’s name on a separate card. If those cards were thrown out a second story window, they would scatter and fall to the ground in a chaotic display. The scattering of the cards over time as they fall to the ground illustrates the law of entropy. The evolutionist would say that the reason that the cards did not fall to the ground in order, spelling out the person’s name, is that they were not given enough time to become orderly. The evolutionist would advise one to get into an airplane and throw the cards out of the plane when it reached an altitude of 10,000 feet. By the theory of evolution the more time the cards are in the air falling, the more time they have to organize and spell out the person’s name when they finally land on the ground. According to the law of entropy, and common sense, giving the cards more time to fall to the ground only increases the disorder. The evolutionist, however, contrary to the laws of science and common sense, would have you believe that the more time the cards have to fall to the ground, the more orderly they will become.

The theory of evolution, which flows from a heathen religious philosophy, is the seed that germinated into communism and socialism. The Jewish Encyclopedia states that Judaism is not contrary to the theory of evolution and admits that evolution has been applied to every part of society.

Herbert Spencer and others have applied the theory of evolution to every domain of human endeavor—civilization, religion, language, society, ethics, art, etc., tracing the line of development from the homo geneous to the heterogeneous, though recrudescences of and lapses into older forms and types (degeneration, atavism) are by no means excluded. The relation of the teachings of Judaism to this theory is not necessarily one of hostility and dissent.⁸⁶⁷

Hitler, Lenin, Stalin, and Trotsky were all converts to the theory of evolution. Evolution was the foundational philosophy for their political actions and their justification for their maniacal brutality. Once one becomes a believer in evolution, it is a small step beyond that to being a believer in a communist revolution. It is no surprise that the Russian communist revolution was controlled from the beginning by Jews. The atheism of evolution is reconcilable with Judaism; that explains why one sees the seemingly strange occurrence of so many atheistic and agnostic Jews taking part in the Judaic liturgy of the synagogue. The atheism of evolution makes it easy to conclude that if there is no life giver, there is no law giver, no one made me, no one owns me, and, therefore, there is no right and wrong. Thus, there is nothing intrinsically wrong with stealing, assault, torture, murder, even murdering millions of people.

God “hath made of one blood all nations of men for to dwell on all the face of the earth.” Acts 17:26. Racial distinctions are contrary to the commands of God: **"Judge not according to**

the appearance, but judge righteous judgment." John 7:24. See also 1 Samuel 16:7 "But the LORD said unto Samuel, Look not on his countenance, or on the height of his stature; because I have refused him: for *the LORD seeth* not as man seeth; for **man looketh on the outward appearance, but the LORD looketh on the heart.**"

Christians should understand that our war is not a carnal war where distinctions are made between races of people as defined by the pagan world system. Christians are in a spiritual war against unseen "spiritual wickedness in high places." Ephesians 6:12. "**For though we walk in the flesh, we do not war after the flesh: (For the weapons of our warfare are not carnal,** but mighty through God to the pulling down of strong holds;) Casting down imaginations, and every high thing that exalteth itself against the knowledge of God, and bringing into captivity every thought to the obedience of Christ; And having in a readiness to revenge all disobedience, when your obedience is fulfilled. **Do ye look on things after the outward appearance?** If any man trust to himself that he is Christ's, let him of himself think this again, that, as he *is* Christ's, even so *are* we Christ's." (2 Corinthians 10:3-7)

30 Heliocentric “Christianity”

Jesus warned his disciples to beware of the doctrine of the Pharisees and Sadducees. Matthew 16:6-12. The essence of that doctrine is to replace God’s word with man made traditions. Mark 7:7-13. Jesus knew that the worldly traditions of men would be used to turn men away from him. “Beware lest any man spoil you through philosophy and vain deceit, after the tradition of men, after the rudiments of the world, and not after Christ.” (Colossians 2:8)

God prophesied that his warning would go unheeded.

For the time will come when they will not endure sound doctrine; but after their own lusts shall they heap to themselves teachers, having itching ears; And they shall turn away their ears from the truth, and shall be turned unto fables. (2 Timothy 4:3-4)

As prophesied, the modern churches have not heeded Jesus’ warning. Modern churches have, almost universally, bought into the heliocentric myth. That Judaic superstition, masquerading as science, is the foundation upon which Satan has built false doctrines in the churches.

The heliocentric fable creates a misunderstanding of God's creation. To misunderstand God's creation causes a concomitant misunderstanding of the characteristics of God. God has shown man his character through his creation. If man has a misunderstanding of God's creation, he will have a misunderstanding of who God really is. Paul explains this in his letter to the Romans:

[T]hat which may be known of God is manifest in them; for God hath shewed it unto them. For **the invisible things of him from the creation of the world are clearly seen, being understood by the things that are made, even his eternal power and Godhead;** so that they are without excuse. (Romans 1:19-20)

Jesus is God. Jesus created all things in heaven and on earth. There is nothing that has been created that Jesus did not create.

For **by him were all things created, that are in heaven, and that are in earth, visible and invisible**, whether they be thrones, or dominions, or principalities, or powers: **all things were created by him, and for him:** And he is before all things, and **by him all things consist.** And he is the head of the body, the church: who is the beginning, the firstborn from the dead; that in all things he might have the preeminence. (Colossians 1:16-18)

To misunderstand the creation causes those with such misunderstanding to in turn misunderstand the character of Jesus. If one believes in the heliocentric creation, he will necessarily believe in a heliocentric creator. A heliocentric creation does not exist. So also, a heliocentric creator does not exist. A heliocentric

creator is a false god. We have been warned to avoid the preaching of a false gospel, which presents a false Jesus.

But I fear, lest by any means, as the serpent beguiled Eve through his subtilty, so your minds should be corrupted from the simplicity that is in Christ. For if he that cometh preacheth **another Jesus**, whom we have not preached, or if ye receive another spirit, which ye have not received, or **another gospel**, which ye have not accepted, ye might well bear with him. (2 Corinthians 11:3-4)

This false heliocentric Jesus is at the core of many false doctrines. Satan uses the subtle strategy of first undermining the authority of the bible by introducing the concept that God does not really mean what he has said in the bible about the flat earth he has created. Once that seed is planted in the minds of the congregation, the (beguiled and beguiling) pastor can then undermine what God has said about faith and doctrine. Under this rubric where duped (or unscrupulous) pastors portray the scriptures as having meaning other than the expressed words, doctrine becomes malleable.

One example of a false doctrine born of a false heliocentric Jesus is Arminianism. The false Arminian god is no longer the sovereign God of the bible by whom “all things consist.” Instead, the Arminian god is a kind-of super hero, who can foresee things that will happen in the future, but is powerless to interfere with man’s free will.

Arminianism is based upon five false premises: 1: God’s election is conditioned on the free will choice of man; 2: Jesus atoned for the sins of everyone in the world, both saved and unsaved; 3: While man is depraved, God provides a special (prevenient) grace to all men that partially awakens them from their depravity so that they can make a free will choice whether to

believe in Jesus; 4: Man can resist the grace of God; and 5: God assists one who is saved in resisting the temptations of the devil, but a person can by the exercise of his free will reject God and lose his salvation.⁸⁶⁸ For a more detailed discussion of this topic, please read this author's book titled: *The Anti-Gospel: The Perversion of Christ's Grace Gospel*.

Every one of those Arminian beliefs are refuted by the words of Christ in the gospel. The bible makes it clear that Jesus is "the blessed and only Potentate, the King of kings, and Lord of lords." (1 Timothy 6:15) Jesus can not only see things that will happen, he makes those things happen. Jesus created all things, by him his creation consists, and he is a potentate over his creation. He did not leave something as important to his creation as salvation subject to the uncertain vicissitudes of man's free will. Indeed, he stated repeatedly in his word that he is in complete control of our salvation, from beginning to end. He is a creator of all things, even of the faith necessary for salvation. "Looking unto Jesus the author and finisher of our faith." (Hebrews 12:2) Jesus not only authors (creates) our faith, he finishes it to its end: salvation. He truly creates all things and by him all things consist, including faith.

The Arminian Jesus, however, is not the creator of an immovable flat earth and is also not the creator (author) and finisher of our faith. The fictional, heliocentric, Arminian god created a fictional, unstable Earth and thus has unstable doctrine of salvation, whereby man is deemed to be the creator (author) and finisher of his own faith. That is a different Jesus and a different gospel. It is so much easier to sell the Arminian god to the churches when the masses have been inculcated in the far-off heliocentric god.

Such a far-off god only peers through empty space to foresee what man will do. That concept of a detached god is only one step removed from atheism, which is the ultimate end of

heliocentrism. Indeed, under heliocentricism, with the vacuum of space in place of God's abode in heaven, the only rational conclusion is that there is no God. That is why heliocentrism is the very foundation of atheism itself. It stands to reason then that those who hold onto a belief in a god, and at the same time a belief in heliocentrism, would necessarily have a god who is much diminished in his power and influence. For those who believe in a god of a heliocentric universe would necessarily lean toward a concept of a god who is much less active in the day-to-day affairs of man. Where heliocentrism has not totally destroyed all conception of God in the minds of men, it has at least undermined his attributes and created in the minds of men an impotent god.

Arminianism is the natural outgrowth of the belief in a god who has created a heliocentric universe. This false Arminian god leaves the salvation of men up to their own free will decision. The Arminian god will not lift a finger to interfere in man's decision. Arminianism is the half sister of atheism.

For example, John Wesley, who was an ardent Arminian and founder the Methodist Church, admitted that he didn't even believe in the God of the bible. In a 1766 letter to his brother, Charles Wesley, John Wesley bared his soul and revealed to Charles his innermost thoughts. In that letter, which John Wesley never expected to be revealed publicly, he admitted that he preached a faith that he, himself, did not have. John Wesley felt "born along" by some unknown force to do so. God would certainly not compel the preaching of a false gospel. It is, therefore, clear that the unknown force bearing John Wesley along to preach the Arminian gospel was the devil. That is an ineluctable conclusion from Wesley's own words:

In one of my last [letters] I was saying that I do not feel the wrath of God abiding on me; nor can I believe it does. And yet (this is the mystery), **I do not love God. I never did. Therefore I**

never believed, in the Christian sense of the word. Therefore I am only an honest heathen... And yet, to be so employed of God! And so hedged in that I can neither get forward nor backward! Surely there was never such an instance before, from the beginning of the world! If I ever have had that faith, it would not be so strange. **But I never had any other evidence of the eternal or invisible world than I have now; and that is none at all,** unless such as faintly shines from reason's glimmering ray. **I have no direct witness (I do not say, that I am a child of God, but) of anything invisible or eternal.**

And yet I dare not preach otherwise than I do, either concerning faith, or love, or justification, or perfection. And yet I find rather an increase than a decrease of zeal for the whole work of God and every part of it. I am borne along, I know not how, that I can't stand still. **I want all the world to come to what I do not know.**⁸⁶⁹

Wesley was 63 years old when he wrote that letter. The dirty secret of Wesley is that he was a heathen, who did not believe in God. He preached a false gospel about a false god, in whom he did not really believe. How could Wesley so successfully preach a false gospel? Because people had been accustomed to ignoring God's words and accepting a contradictory gloss to those words. This process was born with heliocentricity, where it was necessary for the "Christian" churches to accommodate the new science of heliocentricity by reinterpreting God's word to conform with that so-called "science." The Arminian god appears nowhere in the scriptures.

Wesley's Arminianism was only a hair's breath from atheism. There is little difference between the Arminian god, who

minds his own business and leaves his creatures to their own devices, and no god at all. It is no wonder then that Wesley did not believe in God. His Arminian theology created a god in whom it is easy to lose belief. The devil, that subtle beast, could not have designed it any better.

The God of the bible, on the other hand, is a loving God, who effectually intervenes to save his elect. God's word is clear. It is not by one's own will or efforts in keeping God's law that one is saved. Rather, it is by God's grace through faith in Jesus Christ that we are born again. "Jesus answered and said unto him, Verily, verily, I say unto thee, Except a man be born again, he cannot see the kingdom of God." (John 3:3) A man cannot birth himself. To be spiritually reborn requires the intervention of God.

We, who believe in the Jesus of the bible, are adopted children of God. We were chosen by God for adoption before the world was created. **"According as he hath chosen us in him before the foundation of the world, that we should be holy and without blame before him in love: Having predestinated us unto the adoption of children by Jesus Christ to himself, according to the good pleasure of his will."** (Ephesians 1:4-5) Notice that salvation is according to the good pleasure of God's will, not the good pleasure of man's will.

Arminians will argue that man must of his own free will believe in Jesus to be saved. While it is true that faith is necessary for salvation, the source of that faith is Jesus. That's right, Jesus is both the object of one's faith and the source of that faith. Jesus is the author (creator) of saving faith. Hebrews 12:2. God did not just foresee that his elect would believe in him, he predestined that saving faith. Jesus is the finisher of our faith. Jesus sees that faith to its end.

We, who believe in Jesus Christ, were predestined to be glorified with Christ. **"For whom he did foreknow, he also did**

predestinate to be conformed to the image of his Son, that he might be the firstborn among many brethren. Moreover whom he did predestinate, them he also called: and whom he called, them he also justified: and whom he justified, them he also glorified.” (Romans 8:29-30) From beginning to end, salvation is the work of a sovereign God. We are not insignificant beings on an insignificant planet careening through endless space. We are the unique creation of a sovereign God. We are created in his image on a flat immovable Earth, where he watches over us and guides us. He saves his elect according to his sovereign grace through faith in Jesus Christ.

In order to accept the heliocentric model, it is necessary for a Christian to redefine the words in the bible to explain away its depiction of the flat earth. Once a Christian is down the road of rejecting God’s description of a flat earth in the bible, it is easy for him to redefine the words in the bible in other matters of doctrine. For example, Arminians cannot ignore the plain language in the bible that God predestined his elect for salvation. Arminians simply redefine the word “predestinate.” Arminians claim that “predestinate” when referring to God’s election of those to be saved is limited to mean only that God knows those who will exercise their free will and believe in Jesus. The Arminian interpretation is that “God, in his divine foresight, looked down through the corridors of time and saw all of those who would choose salvation in Jesus Christ. Having this divine knowledge, He then ratified men’s votes of confidence in His ability to save them.”⁸⁷⁰

One can perceive in the Arminian doctrine their concept of a far-off god who looks from afar “through the corridors of time” at those who would believe in him. The God of the bible, however, is not far off. He is near. God is above us walking in the circuit of heaven. “Thick clouds are a covering to him, that he seeth not; and he walketh in the circuit of heaven.” (Job 22:14) He is a sovereign potentate, who actively saves his elect. He is not

simply a ratifier of man's decisions as purported by Arminians. God states that he looks upon all the inhabitants of the earth from his habitation in heaven. "From the place of his habitation he looketh upon all the inhabitants of the earth." (Psalms 33:14)

Romans 8:29-30 states that not only did God foreknow, "he also did predestinate." God makes a clear distinction between foreknowing and predestinating. Notice, God "also did predestinate." The Arminians, however, contradict God and misread that passage to say: "he did foreknow, he also did foreknow." That make no sense. The bible states that God both foreknew and predestinated his elect.

"Foreknow" is a word that is pregnant with meaning. It not only means to know beforehand, but it also means to love beforehand. The heliocentric Arminian god does not predestinate his elect for salvation, and he does not love them beforehand, he only knows ahead of time those who would believe in him. The Arminian god is not the God of the bible. The God of the bible predestined his elect for salvation, whereas the fictional, Arminian god only foreknows those who will believe in him. The Arminian god is an ineffectual ratifier of the decisions of sovereign man.

It is necessary for God to intervene to save us, because we are incapable of saving ourselves. God explains in Ephesians:

And you hath he quickened, who were dead in trespasses and sins; Wherein in time past ye walked according to the course of this world, according to the prince of the power of the air, the spirit that now worketh in the children of disobedience: Among whom also we all had our conversation in times past in the lusts of our flesh, fulfilling the desires of the flesh and of the mind; and were by nature the children of wrath, even as others. But God, who is rich in mercy, for

his great love wherewith he loved us, **Even when we were dead in sins, hath quickened us together with Christ, (by grace ye are saved;)** And hath raised us up together, and made us sit together in heavenly places in Christ Jesus: That in the ages to come he might shew the exceeding riches of his grace in his kindness toward us through Christ Jesus. **For by grace are ye saved through faith; and that not of yourselves: it is the gift of God:**” (Ephesians 2:1-8)

We are saved by God’s grace through faith in Jesus Christ. Arminians protest that faith is authored by the free will of man. However, the bible expressly states that Jesus is the author of our faith. Faith is “not of ourselves; it is the gift of God.” Ephesians 2:8. God makes that point even more clear in John, where he states emphatically that power to believe in Jesus Christ unto salvation is given by God. The faith that is the basis to be born again does **not** come from will of man but is rather “**of God.**”

But as many as received him, to them **gave he power** to become the sons of God, even to them that believe on his name: **Which were born, not of blood, nor of the will of the flesh, nor of the will of man, but of God.**” (John 1:12-13) (emphasis added)

When God states that he created all things visible and invisible, he means just that. He created “all things.” You will notice that among the all things that God created were “powers.” Ephesians 1:16. In John 1:12 we see that one of those powers is “power to become the sons of God, even to them that believe on his name.” The all things visible and invisible created by God includes the faith to believe in Jesus Christ.

A heliocentric creator, on the other hand, is a god who

seems to have little control over his creation. A heliocentric creator is removed beyond the infinite realm of the vacuum of outer space. The false heliocentric god of Arminianism only foresees what people will do, but he will not intervene in the affairs of men.

Arminians have their god so far out of the picture that they do not allow their god to interfere in any way in the salvation decision. An Arminian believer who exercises his free will to choose to be saved can later exercise that same free will to jettison his salvation. The true God of the bible is not so fickle. He saves his elect to the uttermost. "Wherefore he is able also to save them to the uttermost that come unto God by him, seeing he ever liveth to make intercession for them." (Hebrews 7:25)

One might think that there must be some passage in the bible that supports the Arminian theology. No, there is no such bible passage. In order to suggest that there is biblical authority, the Arminians use the satanic trick of quoting bible verses out of context. Virtually any false doctrine can be supported by biblical text taken out of context, even to the extent of trying to prove that "there is no God." Indeed, Psalm 14:1 states: "There is no God." It is an accurate quote, but it has been taken out of context.

When we see the passage in context, we see that the quoted clause has quite a different meaning. The entire passage reads: "The fool hath said in his heart, There is no God. They are corrupt, they have done abominable works, there is none that doeth good." Psalm 14:1. The context we see gives quite a different meaning than is intended by our hypothetical atheist. In like manner, Arminians take bible verses out of context to promote a meaning contrary to God's intended meaning.

One example where Arminians twist God's meaning is found in the bible passage often cited by Arminians to support their unbiblical doctrine that God is willing that everyone in the

world should be saved. Arminian churches to part of 2 Peter 3:9, taken out of context, as authority for their doctrine. In fact, this single passage is so key to the Arminian theology that it is the motto of the *Society of Evangelical Arminians*.⁸⁷¹ Figure 2 shows their seal, containing the statement: “**Not Willing That Any Should Perish**”, which is a clause taken out of context from 2 Peter 3:9.

The Arminians have hijacked the gospel and all of the terms that have traditionally been used in the Christian community to describe orthodox biblical Christianity. An organization calling itself the *Society of Evangelical Arminians* makes no historical sense. While almost all Arminians consider themselves evangelicals, they deny the foundational biblical doctrines that are at the core of what it historically meant to be an evangelical. Dr. Michael Scott Horton, who is the J. Gresham Machen Professor of Systematic Theology and Apologetics, in his article *Evangelical Arminians, Option or Oxymoron?*, explains that it is an oxymoron for an Arminian to be described as an evangelical.

[T]he evangelicals who faced this challenge of Arminianism universally regarded it as a heretical departure from the Christian faith. One simply could not deny total depravity, unconditional election, justification by grace alone through faith alone because of Christ alone, and continue to call himself or herself an evangelical. There were many Christians who were not evangelicals, but to be an evangelical meant that one adhered to these biblical convictions. ... Today one can be an evangelical-which has historically meant holding to total depravity, unconditional election, justification by grace through faith alone, the sufficiency of scripture-and at the same time be an Arminian, denying or distorting this very evangelical message.⁸⁷²

Franklin Graham, son of Billy Graham, speaking on behalf of the Billy Graham Evangelistic Association, stated: “According to 2 Peter 3:9, the Lord is ‘not willing that any should perish but that all should come to repentance.’”⁸⁷³

At first glance it would appear that 2 Peter 3:9 supports what Graham has said. Closer examination of that passage reveals that the passage does not in fact support that false Arminian doctrine promoted by Graham. Notice the missing passage. “The Lord is [...] not willing that any should perish, but that all should come to repentance.” 2 Peter 3:9.

Those who try to force the square peg of scripture into the round hole of their false doctrine must shave off parts of the bible in order to get it to fit. In this case, Graham, as is the practice with all Arminians, shaved that portion of the passage which limits its application to those who are already chosen for salvation. What God means in that passage is that God is not willing that any who have been chosen for salvation by God should perish, but that all those who are saved should come to repentance. Read the entire passage in context and you will see that God is “**longsuffering to us-ward.**” God is not willing that “us” should perish and that “us” should come to repentance.

The Lord is not slack concerning his promise, as some men count slackness; **but is longsuffering to us-ward**, not willing that any should perish, but that all should come to repentance. 2 Peter 3:9.

Who are the “us” in 2 Peter 3:9? Simply read the first paragraph of the letter and we see that Peter is writing to “them that have obtained like precious faith with us.” “Simon Peter, a servant and an apostle of Jesus Christ, **to them that have obtained like precious faith with us** through the righteousness of God and our Saviour Jesus Christ:” (2 Peter 1:1)

One can see that in 2 Peter 3:9, Peter was stating that God was not willing that any who believe in Jesus should perish. God's will is always done, and his will cannot be thwarted by man's will. If God has foreordained one to salvation, no one can stay his hand. "And all the inhabitants of the earth are reputed as nothing: and he doeth according to his will in the army of heaven, and among the inhabitants of the earth: and none can stay his hand, or say unto him, What doest thou?" (Daniel 4:35)

While the Arminian salvation is tenuous, the true salvation by and through God is eternal and permanent. "**All that the Father giveth me shall come to me; and him that cometh to me I will in no wise cast out.**" (John 6:37)

All who are chosen by the Father for salvation will be saved. Notice in John 6:37 that Jesus made the points that 1) "**All that the Father giveth me,**" 2) "**shall come to me**"; and 3) "**him that cometh to me I will in no wise cast out.**" We see: 1) God gives **all** of elect to Jesus, 2) **all** of his elect will come to Jesus, and 3) **all** of his elect will be securely saved and cannot lose their salvation. John chapter 6 precludes the possibility of falling away from salvation. Chapter 6 of John refutes the Arminian theology. God uses parallelism in John 6:39-40 to lock down what he means when he states that salvation comes by the faith of which he is the author and finisher.

"And this is the Father's will which hath sent me, that of all which he hath given me I should lose nothing, but should raise it up again at the last day." (John 6:39)

"And this is the will of him that sent me, that every one which seeth the Son, and believeth on him, may have everlasting life: and I will raise him up at the last day." (John 6:40)

Notice that in John 6:40 states that "every one which seeth the Son, and believeth on him, may have everlasting life." It is

those same believers in verse 40 that Jesus states in verse 39 are given to him by the Father: “of all which he hath given me I should lose nothing.” That means that all whom the Father has given to Jesus will “believeth on him.” God preordained that they would believe in Jesus and gave them to Jesus. Jesus will lose none of those who believe on him. Jesus will “raise him up at the last day.” Salvation is locked in once it is given to the believer by the grace of God. “Every” person who believes on Jesus are the same “all” whom the Father has given Jesus. None of those believers will ever be lost; they all have “everlasting life.” They “all” will be raised up on the last day.

Just to punctuate the point Jesus made it clear in John 6:44 that “No man can come to me, except the Father which hath sent me draw him: and I will raise him up at the last day.” (John 6:44) The very theme of the bible that salvation is only by the grace of God through faith in Jesus Christ. E.g., Ephesians 2:8. Combine John 6:44 with verses 37, 39, and 40 of John chapter 6, and we see that it is only those who believe in Jesus who can be saved. All whom God has ordained to believe in Jesus will in fact believe in Jesus unto salvation. No believer will ever be lost. “All that the Father giveth me shall come to me; and him that cometh to me I will in no wise cast out.” (John 6:37) All believers will inherit eternal life. “I will raise him up at the last day.” John 6:40 and 6:44.

On the flip side, without the ordained election of God, no man can believe in Jesus. It is those, and only those, whom God draws to Jesus who will be saved. John 6:44. God’s drawing is effectual, all who are drawn will in fact believe in Jesus unto salvation. John 6:39-40. All who do not believe in Jesus are ordained by God not to believe in Jesus. “No man can come to me, except the Father which hath sent me draw him.” John 6:44.

Jesus ended his discourse in John chapter 6 with that very point. He stated that there were some among his audience who did

not believe in him. And Jesus explained why. Because, he stated, “no man can come unto me, except it were given unto him of my Father.”

But there are some of you that believe not. For Jesus knew from the beginning who they were that believed not, and who should betray him. And he said, Therefore said I unto you, that no man can come unto me, except it were given unto him of my Father.” (John 6:64-65)

How do Arminians address John chapter 6? They reinterpret the language to say that God’s drawing is only effectual for those of their own free will who choose to believe in Jesus. They claim that not all who are drawn will believe in Jesus and be saved. The problem with that interpretation is that it ignores the clauses Jesus put at the end of verses 37, 39, 40, and 44. Those clauses mean that of **all** whom the Father has given to Jesus, he draws **all** of them to Jesus, they **all** will believe in Jesus, and they **all** will be saved. “I will in no wise cast out.” John 6:37; “I should lose nothing, but should raise it up again at the last day.” John 6:39; I will raise him up at the last day.” John 6:40; “I will raise him up at the last day.” John 6:44.

Those clauses alone impeach the entire Arminian construct. How do Arminians address those clauses? Arminians ignore those clauses, as though they are not there. They do not even try to explain them, because there is simply no way to reconcile their Arminian theology with God’s clear words.

Ken Johnson, Th.D., is typical in that regard. In his deceptive book, *The Gnostic Origins of Calvinism*, Johnson cites to the verses in John 6:37, 39, and 44 in support of the proposition that “[t]he Holy Spirit draws men to Himself with grace.”⁸⁷⁴ While that is certainly true, immediately after citing to those bible passages, Johnson ignores the clear language in those passages to

say: "But this drawing can be resisted."⁸⁷⁵ How can he make such a statement after typing out three bible passages, all of which taken together (or even read separately) mean clearly that all those who are drawn by God to Jesus, will in no wise be cast out, but that Jesus will raise them up on the last day? Jesus states emphatically "that of all of which he hath given me, I should lose nothing, but should raise it up again at the last day." John 6:39. Jesus allows no possibility for resisting the drawing of God. The drawing of God is effectual and leads to salvation. Clearly Dr. Johnson has an Arminian agenda. And his agenda does not include being a faithful witness to the word of God.

There are two groups of people in the world: 1) those whom God draws to Jesus for salvation, and 2) those whom God does not draw to Jesus for salvation. Those who are drawn by God to Jesus are ordained by God to be saved. Whereas, those who are not drawn by God to Jesus are ordained by God to be damned. "No man can come to me, except the Father which hath sent me draw him: and I will raise him up at the last day." (John 6:44)

There are those, like Judas, who appear for a time to be part of the church but in the end they make manifest that they are enemies of the gospel. "They went out from us, but they were not of us; for if they had been of us, they would no doubt have continued with us: but they went out, that they might be made manifest that they were not all of us." (1 John 2:19) Judas and others like him went out, not because they were saved and lost their salvation, but rather because from the beginning "they were not of us." That is, they were pretenders to salvation; they were unsaved tares congregating among the saved wheat. Matthew 13:27-43.

Those who do not believe in Christ are lost because they have not been chosen by God for salvation. Those who are chosen for salvation cannot lose their salvation. John 10:26-30. There is simply no such thing as a person losing his salvation.

But ye believe not, because ye are not of my sheep, as I said unto you. My sheep hear my voice, and I know them, and they follow me: And I give unto them eternal life; and they shall never perish, neither shall any man pluck them out of my hand. My Father, which gave them me, is greater than all; and no man is able to pluck them out of my Father's hand. I and my Father are one. (John 10:26-30)

There are only two possibilities in the gospel. First, those who are lost cannot believe, because God has not chosen them to believe. The other possibility is the flip side of the first. Those who are chosen to believe will in fact believe, and they cannot ever lose their faith. Jesus promised that “no man is able to pluck them out of my Father’s hand.” There is no category for persons to be first saved and then for them to overrule God’s choice by the power of their free will and “unsave” themselves. Such an occurrence is an impossibility. The only way to build such a theology is to ignore the clear message of the gospel.

God’s creation reveals his very character. If people are deceived by heliocentrism, they then have a perverted view of creation and thus a perverted view of their god. Heliocentrism creates in the minds of men a different kind of god. The heliocentric god is a god made after the image of man. Under heliocentrism, man is all powerful, with the heliocentric god being a far-off helpless and hapless spectator, unable to intervene to save anyone. Indeed, there is very little difference between such a god and no god at all. The whole point of heliocentrism is to remove the God of the bible from people’s minds. As the heliocentric creation does not exist, so also, the heliocentric creator does not exist. All religions that worship a heliocentric creator worship a false god. From that misguided worship flows all manner of false doctrine.

The God of the bible is real. He is the creator of a real earth that is at the center of his creation. He intervenes in the affairs of men to effectually save his people. The gospel is simple. Salvation comes only by the grace of God through faith in Jesus Christ. John 6:47; Ephesians 2:8-10. No man can be saved unless God elects to save him. John 6:65. All whom God elects to save will be saved. John 6:39.

God makes one a Christian. God must change your heart. As Jesus said, a man must be born again. John 3:3. No man is born of himself. One must be born of God. "Know ye that the LORD he is God: it is he that hath made us, and not we ourselves; we are his people, and the sheep of his pasture." (Psalms 100:3) Salvation is not by the will of man. "Which were born, not of blood, nor of the will of the flesh, nor of the will of man, but of God." John 1:13. God must draw you. John 6:44. Unless God draws a man, he will have no desire to be a Christian.

Man by nature is spiritually dead. God must quicken you, that is, make you spiritually alive. Ephesians 2:1-10. You then become a new spiritual creation through God's Holy Spirit.

There is no way that a man would accept those things written in the Holy Bible unless God has first opened his heart to the spiritual truths in the Bible. If one accepts that Jesus Christ is Lord God, the creator of the universe who reigns from heaven, he should submit completely to his authority. Ask the Lord in prayer to help you and he will. "And straightway the father of the child cried out, and said with tears, Lord, I believe; help thou mine unbelief." Mark 9:24.

Understand this simple truth, that if you ask Jesus to save you, he will. You will not, indeed you cannot, unless God draws you and gives you the ability to do so. He will then give you the gift of the Holy Spirit. Pray to Jesus for salvation.

And he said unto them, Which of you shall have a friend, and shall go unto him at midnight, and say unto him, Friend, lend me three loaves; For a friend of mine in his journey is come to me, and I have nothing to set before him? And he from within shall answer and say, Trouble me not: the door is now shut, and my children are with me in bed; I cannot rise and give thee. I say unto you, Though he will not rise and give him, because he is his friend, yet because of his importunity he will rise and give him as many as he needeth. And I say unto you, **Ask, and it shall be given you; seek, and ye shall find; knock, and it shall be opened unto you. For every one that asketh receiveth; and he that seeketh findeth; and to him that knocketh it shall be opened.** If a son shall ask bread of any of you that is a father, will he give him a stone? or if he ask a fish, will he for a fish give him a serpent? Or if he shall ask an egg, will he offer him a scorpion? If ye then, being evil, know how to give good gifts unto your children: how much more shall your heavenly Father give the Holy Spirit to them that ask him? (Luke 11:5-13)

Those that ascribe to the free will mythology will cite the above passage as authority for their position that the source of faith is the will of man. However, that passage says nothing of the source of the faith, the passage simply explains the result of faith.

Faith comes from God, it is a gift; he will shower you with his merciful grace if you ask him. You must humble yourself before almighty God and ask for his mercy and grace. The only way that you can come to Christ is if he draws you and causes you to ask him to save you. John 6:44. **“Blessed is the man whom thou choosest, and causest to approach unto thee, that he may**

dwelt in thy courts: we shall be satisfied with the goodness of thy
house, even of thy holy temple.” (Psalms 65:4)

 pdfelement

31

The Inevitable Shills

The world conspiracy against God and man has its shills that it presses into service in order to undermine any effort to expose its plans. Exposing heliocentrism as a lie and presenting evidence of a flat earth simply cannot be allowed. A video titled *Flat Earth*, posted on You Tube by Joseph Flatley on March 21, 2015, illustrates the methods used by the ruling elite to coopt any opposition to them. *Flat Earth* is an excellent video, and makes a very compelling case for the flat earth. The poster of the video, Joseph Flatley, summarizes his views in one of his comment postings on the video page:

The Earth is Flat 1. No satellites, just under sea cable, radar and cell towers 2. We are not spinning 3. Horizon is flat 4. There is no gravity, just temperature, mass, pressure and density 5. We are not moving upwards either 6. Coriolis effect can be seen on an airplane (both directions simultaneously) 7. Antarctica surrounds us and goes on forever 8. We are in a melted puddle of ice 9. Sun and moon are very small and circle above us 10. Man cannot fly higher than 80,000 feet (ha ha to Virgin) 11. Historic tests were

conducted that proved that the ether circles as 12. Whatever NASA, Disney and Hollywood preach, believe the opposite to be true 13. Photos of earth in space are paintings and graphics.⁸⁷⁶

Flatley seems emphatic about his beliefs in a flat earth. In his comments, he calls those who believe in a globular earth “globetards.”

I am so sick of the brainwashed globetards. They say that our ancestors were unintelligent, when they themselves do not realize that we were all part of the 'dumbing down of society' agenda. People from the past were brilliant compared to us. When they observed and recorded that the Earth was FLAT.....they were right. We were fooled our whole lives. Wake the hell up everyone. Picture yourself putting a clear cup upside down on your floor to catch a bug. Your floor represents the vastness of Earth, the cup represents the DOME and the bug is one of us. Flat Earth is not a disc you can fall from, the plane goes on forever in all directions. WAKE THE HELL UP.⁸⁷⁷

The problem with all of this is that if Flatley believes what he is saying, he is perfectly willing to try to deceive people about the truth of it. He is a shill, who is apparently trying coopt and control information about the flat earth. How do I know? On September 20, 2015, only 6 months after posting the above video, and while the video was still posted, he wrote an article attacking those who believe in a flat earth. Below is an excerpt of the hatchet job that he did on Rich Hopkins, who seems to be an honest seeker of the truth who has uncovered irrefutable proof of a flat earth.

Since [Rich] Hopkins’s flat Earth ideas involve all the traditional conspiracy tropes (and since conspiracy theory itself has anti-Semitism in its DNA) I had to ask: Does he believe that the Holocaust happened?

“I don’t know,” Hopkins says. “I wasn’t there. Like, a lot of people say, ‘Do you believe in the Holocaust?’ I wasn’t there, I don’t know. All I know is that the people that win the wars write the history.” He refuses to believe something just because it’s taught in school. “I guess I’d have to go over to Germany and do some forensic examination to prove it.”

This isn’t science, and this isn’t skepticism. It’s stupidity. While this one guy’s crank idea probably isn’t too terribly dangerous, it reflects a larger problem of rejecting scientific understanding—not an inability to understand science, but a refusal of its methods and conclusions. How will we possibly hope to thrive and survive, mister, if we’re wasting precious time and energy trying to figure out if the Earth is round, if the moon is real, or if the Holocaust even happened? Everything’s up in the air, floating over an obviously, demonstrable, inarguably flat Earth.⁸⁷⁸ (emphasis added)

Notice how Flatley inadvertently revealed the real issue. He seemingly goes completely off-topic and states in the article “conspiracy theory itself has anti-Semitism in its DNA.” He then segues right into a question about the Holocaust. In doing this, he revealed more about himself than he planned to.

Vladmir Lenin explained the communist principle that

“the best way to control the opposition is to lead it ourselves.” As previously revealed, a little known fact is that Lenin was a Jew. It is notable that Flatley attempts to smear those who believe in any conspiracy, especially flat earth conspiracy, as anti-Semites. He knows that the slightest examination of heliocentricity will reveal that it is based upon esoteric Jewish religious beliefs originating in Babylon and nurtured by the Jews in their Kabbalah and Talmud. That is why he stated in the context of flat earth science, “conspiracy theory itself has anti-Semitism in its DNA.”

False claims of antisemitism are used as a shield to protect the Jewish hierarchy when evidence of their crimes are uncovered. Former Israeli government official Shulamit Aloni succinctly described the epithet antisemite as “a trick we [Jews] always use.”⁸⁷⁹ She explained that Jews hide behind it like a smokescreen, which is used to conceal evidence of Jewish malefaction.

Shulamit Aloni knows what she is talking about. She was a member of the Israeli Knesset from 1965 to 1969 and again from 1974 to 1996. She served on the Knesset Constitution Committee, Law and Justice Committee; State Audit Committee; Education and Culture Committee; and the Finance Committee. She served briefly as Minister without Portfolio from June to October 1974. From 1992 to 1996, Aloni served as Minister of Communications and the Arts, Science and Technology.⁸⁸⁰

By the trick of labeling a person as an antisemite, the accused person’s credibility is undermined, and the focus shifts from the evidence against wrongdoing by the Jews to the motives of the accused antisemite. The Jewish controlled media then destroys the reputation of the accused antisemite, and he becomes an object lesson for anyone who might consider criticizing Israel or Jews.

Indeed all secret societies employ undercover agents of infiltration who seek to control the opposition by gaining a

leadership position in that opposition. For example, the preamble to the Extreme Oath of the Jesuits states in pertinent part:

My son, heretofore you have been taught to act the dissembler: among Roman Catholics to be a Roman Catholic, and to be a spy even among your own brethren; to believe no man, to trust no man. Among the Reformers, to be a Reformer; among the Huguenots, to be a Huguenot; among the Calvinists, to be a Calvinist; among other Protestants, generally to be a Protestant; and obtaining their confidence, to seek even to preach from their pulpits, and to denounce with all the vehemence in your nature our Holy Religion and the Pope; and even to descend so low as to become a Jew among Jews, that you might be enabled to gather together all information for the benefit of your Order as a faithful soldier of the Pope.⁸⁸¹

Joseph Flatley has been acting the part of a flat earth believer, as a way of controlling and undermining the growing awareness of it. He has Jesuitically pretended to believe in a flat earth and even posted a professionally polished video promoting his views in agreement with the evidence for a flat earth. At the same time he has been caught in his published article stating that believing in the flat earth “isn’t science,” and it “isn’t skepticism.” No, Flatley thinks “[i]t’s stupidity.” In his article, he called the idea of a flat earth a “crank idea.” He accuses those who believe in a flat earth of “rejecting scientific understanding.”

Flatley goes in for the kill in his article and tries to associate anyone who believes in a flat earth as being an antisemite, denying the Holocaust. Indeed, Flatley stated outright his position that “conspiracy theory itself has anti-Semitism in its DNA.” Flatley tries, unsuccessfully, to paint Rich Hopkins (and by

association all who believe in a flat earth) as a Holocaust denier. Saying that Hopkins views on the flat earth are “wasting precious time and energy trying to figure out if the Earth is round, if the moon is real, or if the Holocaust even happened.”⁸⁸² Although Hopkins has never publically spoken about the Holocaust, Flatley tries to imply that Hopkins is a Holocaust denier. Flatley hopes by doing that to cause the vast majority of people to have a visceral Pavlovian response, which has been pre-programmed by years of Jewish Holocaust propaganda, of rejecting the science of the flat earth and instead believing the heliocentric religion passing as “science.”

Who really is Joseph Flatley, and why is he so interested in the flat earth? Flatley seems to have an expertise in the area of social media, particularly as it affects Israel. He seems to have taken a great interest in the leveraging of social media for propaganda purposes by the Israeli Defense Forces (IDF) in its battles with Hamas in and around the Gaza strip and elsewhere.⁸⁸³ Flatley has written several articles on that topic for *The Verge*.⁸⁸⁴

Indeed, Flatley seems to be hooked into the massive social media and internet propaganda effort by Israel. As reported at *Zero Hedge*, “Israeli service men are not the only ones engaged in pro-Israeli social media efforts. As we've noted for years, Israel has employed its civilians to automatically vote stories questioning Israel down and to send pro-Israel letters to politicians and media.”⁸⁸⁵ Jonathan Cook reported in July 2009, that “Israel’s foreign ministry is reported to be establishing a special undercover team of paid workers whose job it will be to surf the internet 24 hours a day spreading positive news about Israel.”⁸⁸⁶ Notably, the *Zero Hedge* article quoted Joseph L. Flatley, apparently due to his expertise on the subject. The *Zero Hedge* article ends with stark evidence of how important propaganda is to Israel: “Indeed, Israeli prime minister Netanyahu publicly thanked Israel's keyboard warriors for battling on social media for the cause.”⁸⁸⁷

Who are these “keyboard warriors” to which Netanyahu refers? In January 2012, Ali Abunimah reported that the National Union of Israeli Students had partnered with the Israeli government to pay students \$2,000 to spend 5 hours per week in spreading pro-Israel propaganda on the internet.⁸⁸⁸ It took four years, but finally the major media decided to report on Jonathan Cook’s 2009 allegations. However, the major media made to sound like the internet propaganda effort by Israel was just getting off the ground in 2013, when in fact it had been going on for at least four years by the time the Associated Press reported it. In an August 14, 2013, article, the Associated Press reported that “Israel is looking to hire university students to post pro-Israel messages on social media networks without needing to identify themselves as government-linked, officials said Wednesday.”⁸⁸⁹

Flatley’s schizophrenic positions of being both pro-flat earth and anti-flat earth at the same time certainly suggest a nefarious motive. Could Flatley be part of Israel’s effort to spread Israeli propaganda? If so, it would seem that the State of Israel has an interest in putting a stop to any evidence of a flat earth being spread to the masses. In view of the fact that the heliocentric globular earth model at its core is a Kabbalistic religious belief, it would stand to reason that Israel would want to stop any information that impeaches it. Israel certainly wants to put a stop to any in-depth research on the issue, as it would lead directly to the Jews as the prime source of the myth of a globular, spinning earth. That explains Flatley’s segue into allegations of antisemitism and Holocaust denial in his flat earth article.

32

Compromising the Faith

Heliocentricity is so ingrained within the world's culture that many Christian ministries refuting evolution cling to the heliocentric model of a globular, spinning earth, despite clear biblical passages that refute that model. For example, Robert Carter, Ph.D., coauthored an article titled, *Why the Universe Does Not Revolve Around the Earth, Refuting Absolute Geocentrism*, which was posted on the *Creation Ministries International* website on February 12, 2015.⁸⁹⁰ In the article, Dr. Carter explained away the bible passages describing the geocentric creation by arguing that God was not accurately describing the movement of the sun, but that God was instead using "phenomenological language." Below is a dialogue that this author had with Dr. Carter in the comments section to his article.

Edward H., United States, 25 February 2015:

You subtitled the article "Refuting absolute geocentrism," but you did no such thing. A refutation is proof that something is wrong. You presented arguments against geocentricity, but your article can hardly be termed a refutation. To

refute geocentricity would require proof. However, you have craftily dodged and avoided some strong scientific and biblical arguments that support geocentricity. For example, you made passing reference to Isaiah 38:1–7, but you did not cite or discuss the operative passage that proves geocentricity, which appears in verse 8. Why not? If you are refuting geocentricity, one would think that you would address Isaiah 38:8. “Behold, I will bring again the shadow of the degrees, which is gone down in the sun dial of Ahaz, ten degrees backward. So the sun returned ten degrees, by which degrees it was gone down.” Isaiah 38:8. That passage clearly states that “the sun returned ten degrees, by which degrees it was gone down.” God is stating clearly that he moved the shadow on the sun dial ten degrees by moving the sun back in its path by ten degrees. Your statement that God is using “phenomenological language” in the bible passages that support geocentricity is just a clever way of saying that God is telling us a fib, because we are too dense to understand what is really happening. God could have easily stated that he moved the earth back ten degrees in its rotation, if that is what he had done. I think we could understand that phenomenon. God did not say that, because he did not do that. God is not lying to us about what he did by using what you call “phenomenological language.” God explained exactly what happened, “the sun returned ten degrees, by which degrees it was gone down.” Isaiah 38:8.

Robert Carter responds:

We have not ‘craftily dodged’ anything, and your

argument really amounts to nothing. The refutation is in the physics, and so far nobody has attempted to seriously grapple with it, which is telling. Regarding Isaiah 38:8, the shadow went backwards in the reference frame of those doing the observing. If that happened today, the first-hand reports would use the exact same language even though later pundits would state the earth must have temporarily reversed its spin. I note that God did not say the universe reversed its spin around the earth, only that the sun/shadow went back, which could happen in a geocentric universe if God reversed the spin of the universe OR if He temporarily decoupled the sun (and planets!) from the rotation of the universe. In a geokinetic universe, God could reverse the spin of the earth OR move the sun and planets in their place to produce the same effect (thank you for making me think of this last bit). Therefore, this passage is entirely ambiguous. It does nothing to inform us of the workings of the universe. Nobody is being duplicitous.⁸⁹¹

Dr. Carter stated: “this passage [Isaiah 38:8] is entirely ambiguous. It does nothing to inform us of the workings of the universe.” He seems to think that saying something makes it so. There is not any ambiguity in the passage, and that passage speaks directly to the workings of the universe. The foundation of his biblical argument is a “phenomenological language” tradition that requires three assumptions: 1) someone other than God is viewing the phenomenon, 2) that someone is telling us what he saw, and 3) and what he saw may not actually have happened as he described it. First of all, it is God speaking in Isaiah 38:8. Verse 4 states “then came the word of the Lord to Isaiah.” Isaiah was speaking the words of God Almighty. God stated what he would do:

“Behold, I will bring again the shadow of the degrees, which is gone down in the sun dial of Ahaz, ten degrees backward.” God then stated exactly how he did it. “So the sun returned ten degrees, by which degrees it was gone down.” God says, without ambiguity, that the sun returned the very ten degrees that it had gone down. Yet, Dr. Carter states the passage is ambiguous. In Dr. Carter’s world any passage that contradicts his heliocentric theology is rendered “ambiguous.” The ambiguity is not real. It is a construct of a method of bible interpretation that assumes that God uses “phenomenological language” to say what he does not really mean.

Interestingly, in the biography for Dr. Carter on the Creation Ministries website it states of Dr. Carter: “He says he felt a tremendous joy when he realized his science and his religion were no longer at odds.”⁸⁹² Apparently, he was unwilling to see the religion behind the so-called “science” of heliocentricity and had to somehow find agreement between the heliocentric religion, passing itself as science, and the Christian religion of the bible. Dr. Carter had a problem. He had to make some accommodation for the clear language in the bible indicating a stationary earth. He did this by coming up with a theory that God does not truly mean what he is saying in the bible. Dr. Carter claims that God is using “phenomenological language.”

Carter’s sophistry of alleging that God was using “phenomenological language” in the bible is just another way of saying that God was not telling the truth about what was happening. “Let God be true, but every man a liar.” (Romans 3:4) God does not lie. “God is not a man, that he should lie; neither the son of man, that he should repent: hath he said, and shall he not do it? or hath he spoken, and shall he not make it good?” (Numbers 23:19 AV) Indeed, it is a command of God that Christians are to witness that God reigns, he is righteous, and the world is immovable. “Say among the heathen that the LORD reigneth: the world also shall be established that it shall not be moved: he shall

judge the people righteously.” (Psalms 96:10)

Lest, dear reader, you think that I am being unkind to Dr. Carter, I take my cue from Paul, who did not hesitate to upbraid Peter for his unchristian dissembling.

But when Peter was come to Antioch, I withstood him to the face, because he was to be blamed. For before that certain came from James, he did eat with the Gentiles: but when they were come, he withdrew and separated himself, fearing them which were of the circumcision. And the other Jews dissembled likewise with him; insomuch that Barnabas also was carried away with their dissimulation. But when I saw that they walked not uprightly according to the truth of the gospel, I said unto Peter before them all, If thou, being a Jew, livest after the manner of Gentiles, and not as do the Jews, why compellest thou the Gentiles to live as do the Jews? (Galatians 2:11-14)

While Peter was a feverish worker for the gospel, he was wrong in his approach, just as Dr. Carter is a feverish worker against evolution, but is wrong regarding heliocentricity. Just as did Paul to Peter, in like manner, I am upbraiding Dr. Carter for his dissimulation. What is the dissembling about which Paul speaks in Galatians but concealing one's true thoughts by some pretense or hypocrisy? Dr. Carter's "phenomenological language" construct is so contrary to what it means be a Christian, it is hard to accept that he truly believes it, being, as he claims, a Christian. Dr. Carter seems to have engaged in dissembling similar to that of Peter, when Carter claimed in his article that God is using "phenomenological language" in describing the movement of the sun in the bible. He would certainly object to the claim that God was using "phenomenological language" in the creation account in Genesis. He believes that God meant what he said when he said

he created the world in 6 days. The days were in fact six literal days. Yet, he argues that God did not mean what he said in Isaiah 38.

Dr. Carter is a scientist on the staff of *Creation Ministries International*. The statement of faith for *Creation Ministries International* specifically states, in pertinent part:

The doctrines of Creator and Creation cannot ultimately be divorced from the Gospel of Jesus Christ. ... The 66 books of the Bible are the written Word of God. The Bible is divinely inspired and inerrant throughout. Its assertions are factually true in all the original autographs. It is the supreme authority, not only in all matters of faith and conduct, but in everything it teaches. ... The account of origins presented in Genesis is a simple but factual presentation of actual events and therefore provides a reliable framework for scientific research into the question of the origin and history of life, mankind, the Earth and the universe. ... The days in Genesis do not correspond to geologic ages, but are six [6] consecutive twenty-four [24] hour days of Creation. ... The view, commonly used to evade the implications or the authority of Biblical teaching, that knowledge and/or truth may be divided into ‘secular’ and ‘religious’, is rejected. Facts are always subject to interpretation by fallible people who do not possess all information. By definition, therefore, no interpretation of facts in any field, including history and chronology, can be valid if it contradicts the scriptural record.⁸⁹³

How can Dr. Carter use his “phenomenological language”

to get around the clear statements in the bible, which to do so violates the very statement of faith of *Creation Ministries International*, for which he works? The statement of faith states clearly that “the Bible is divinely inspired and inerrant throughout” and that “it is the supreme authority, in all matters of faith and conduct,” and “in everything it teaches.” The biblical account is a “simple but factual presentation of actual events and therefore provides a reliable framework for scientific research.”

It seems that Dr. Carter and *Creation Ministries International* selectively apply their principle that the bible is the supreme authority in everything they teach only to the account of origins presented in Genesis. Dr. Carter only accepts the Genesis account as being a “factual account of actual events,” but that part of the bible that addresses the cosmos uses “phenomenological language” that can be interpreted contrary to the expressed words, at the whim of the reader. How can that be? What is Dr. Carter’s authority to decide what part of the bible is a “factual account of actual events” and what part of the bible uses “phenomenological language?”

When I asked Dr. Carter about his failure to biblically refute geocentricity in his article, he responded that “the refutation is in the physics.” He confesses in his comment post that the basis for his rejection of an immovable earth is modern “science;” he calls it physics. He based his entire argument on the “scientific” theories that have been constructed upon Copernicus’ heliocentric myth. He uses so-called “science” to overrule the bible. He does the very thing that is forbidden by the *Creation Ministries International* statement of faith, which states in pertinent part, that “no interpretation of facts in any field, including history and chronology, can be valid if it contradicts the scriptural record.”⁸⁹⁴ His approach not only violates the admonition in *Creation Ministries International’s* statement of faith, it also violates the very scriptures he professes to uphold. “O Timothy, keep that which is committed to thy trust, avoiding profane and vain

babbings, and oppositions of science falsely so called. (1 Timothy 6:20)

The key statement in the Creation Ministries International that gives away the game they are playing is: “The 66 books of the Bible are the written Word of God. The Bible is divinely inspired and inerrant throughout. Its assertions are factually true **in all the original autographs.**” (emphasis added). Notice the words: “in all the original autographs.” What the *Creation Ministries International* implies by that statement is that they only stand by the “original autographs.” The problem is that the original autographs no longer exist. Therefore, according to their statement of faith, there is no inerrant word of God that is factually true to which one can point. They assert allegiance to something that does not exist and has not existed for almost two millennia.

God holds his word in even higher esteem than even his name.

[T]hou hast magnified thy word above all thy name. (Psalms 138:2)

God’s name is so precious that the biblical penalty for blaspheming his name is death. Leviticus 24:16. However, God holds his word above even his name. Why? Because God’s word is God’s revelation of him to man. The Holy Bible states that:

In the beginning was the Word, and the Word was with God, and **the Word was God.** The same was in the beginning with God. **All things were made by him;** and without him was not any thing made that was made. (John 1:1-3)

In whom we have redemption through his blood, even the forgiveness of sins: Who is the image of the invisible God, the firstborn of every

creature: **For him were all things created, that are in heaven, and that are in earth, visible and invisible, whether they be thrones, or dominions, or principalities, or powers: all things were created by him, and for him: And he is before all things, and by him all things consist.** (Colossians 1:14-17)

The gospel found in John states that God (the Word, the Creator) came to Earth in the flesh: Jesus Christ.

And the **Word was made flesh**, and dwelt among us, (and we beheld his glory, the glory as of the only begotten of the Father,) full of grace and truth. (John 1:14)

In the Holy Bible God the Father makes it clear that his Son, Jesus, is God.

But unto the **Son** he saith, Thy throne, **O God**, is for ever and ever: a sceptre of righteousness *is* the sceptre of thy kingdom. (Hebrews 1:8)

The Holy Bible is not like any other book; it is unique; it was written by God through men.

All scripture is given by inspiration of God, and is profitable for doctrine, for reproof, for correction, for instruction in righteousness: (2 Timothy 3:16)

Knowing this first, that no prophecy of the scripture is of any private interpretation. For the prophecy came not in old time by the will of man: but **holy men of God spake as they were moved by the Holy Ghost.** (2 Peter 1:20-21)

Which things also **we speak, not in the words which man's wisdom teacheth, but which the Holy Ghost teacheth**; comparing spiritual things with spiritual. But the natural man receiveth not the things of the Spirit of God: for they are foolishness unto him: neither can he know *them*, because **they are spiritually discerned**. (1 Corinthians 2:13-14)

In the beginning God created the heaven and the earth. How did he create? He created by speaking. **“God said . . . and it was so.”** See Genesis 1:1-2:25. “Through faith we understand that the worlds were framed by the word of God, so that things which are seen were not made of things which do appear.” (Hebrews 11:3)

God has promised to preserve his word forever. Even though the original autographs no longer exist, God's word has been supernaturally preserved. God's word is the way to salvation. God would not leave us without the means for our salvation. The following scripture passages testify that God has promised that his word will be preserved forever.

For verily I say unto you, Till heaven and earth pass, one jot or one tittle shall in no wise pass from the law, till all be fulfilled. (Matthew 5:18)

Heaven and earth shall pass away, but my words shall not pass away. (Matthew 24:35)

The words of the LORD *are* pure words: *as* silver tried in a furnace of earth, purified seven times. **Thou shalt keep them, O LORD, thou shalt preserve them from this generation for ever.** (Psalms 12:6-7)

[T]he word of the Lord endureth for ever. And this is the word which by the gospel is preached unto you. (1 Peter 1:25)

The grass withereth, the flower fadeth: but **the word of our God shall stand for ever.** (Isaiah 40:8)

For ever, O LORD, thy word is settled in heaven. (Psalms 119:89)

Dr. Carter's disrespectful "phenomenological language" theory for bible passages goes hand-in-hand with the fact that he seems not to truly believe God's promise to preserve his word. He and the *Creation Ministries International* only consider the original autographs to be God's infallible word. The originals, however, have not been preserved. They are long gone. God never promised to preserve the original autographs, he promised to preserve his word. God's word is spiritual, eternal, and preserved in the English language in the Authorized (King James) Version of the bible. For more information on that issue read this author's book, *Solving the Mystery of Babylon the Great*.

The "phenomenological language" theory simply does not hold up under scrutiny. Take, for example, God causing the sun and the moon to stand still in Joshua 10:12-13.

Then spake Joshua to the LORD in the day when the LORD delivered up the Amorites before the children of Israel, and he said in the sight of Israel, Sun, stand thou still upon Gibeon; and thou, Moon, in the valley of Ajalon. And **the sun stood still, and the moon stayed**, until the people had avenged themselves upon their enemies. Is not this written in the book of Jasher? **So the sun stood still in the midst of heaven,**

and hasted not to go down about a whole day.
(Joshua 10:12-13)

Note that the passage clearly states that the “the sun stood still in the midst of heaven, and hasted not to go down about a whole day.” It did not state that the earth stopped spinning. It states that the sun stood still. Interestingly, it also states that the moon also “stayed.”

A car or motorcycle traveling at a mere 60 miles per hour and coming to a sudden halt would kill all passengers on board. Imagine what would happen to people on Earth, when the 1,000 mile per hour spinning Earth suddenly stopped. People, standing on Earth, would be caused to tumble and crash along the earth with such force as to be killed instantly. Indeed, any physicist worth his salt would understand that if the earth were spinning, as supposed by modern science, at over 1,000 miles per hour at the equator, and it suddenly stopped, there would be complete carnage on Earth for all living things. The oceans still in motion, would flood the continents. The very idea is ludicrous. Yet, in Joshua 10, we have two armies facing each other and they are not the least bit fazed in their footing by the sun and moon stopping. Obviously, it was not the earth that stopped spinning, but rather the sun and moon stopped in their motion over a fixed non-moving Earth, just as the bible describes it.

On September 13, 2016, Dr. Robert Carter again partnered with Dr. Jonathan Sarfati to write an article that went beyond the issue of geocentricity and addressed the issue of the flat Earth. The title of the article will give the reader some idea of the contempt that Drs. Carter and Sarfati have for anyone who accepts that the earth is flat. Their article is titled: *Flat Earth, and Other Nonsense, Dealing with Ideas That Would Not Exist Were it Not for the Internet.*⁸⁹⁵

Their article portrays those who adhere to the flat earth in

the most demeaning terms. They state in the article that belief in a flat earth is pseudoscience that is based upon hype that is being pushed by deceptive charlatans. They characterize belief in the flat earth as a nutty idea, which is only believed because of a tragic flaw in human psychology.

Carter and Sarfati also caution the readers to steer clear of any examination of a conspiracy surrounding the 911 attacks. And for good measure, they specifically poo-poo any thought that the NASA moon landings were hoaxes. Carter and Sarfati then dismiss independent research posted on the internet by stating that “[o]ur only conclusion is that the Internet is breeding people who have trouble thinking through important ideas.”⁸⁹⁶ They think that “[c]learly, the Internet easily radicalizes people.”⁸⁹⁷ Those are not the concerns of truth-seekers; those are the ravings of gatekeepers.

Indeed, Carter and Sarfati begin their insulting and deceptive article by expressing their exasperation at how they must lower themselves to address the issue of the flat earth. “Sadly, we must also take on the subject of whether or not the earth is flat.”⁸⁹⁸ They then proceed to outright lie and pretend that somehow Pythagorean trigonometry proves their case for the spherical earth, when in fact it completely destroys their case. “One of the worst aspects of the flat-Earth claim is that to believe it you also have to deny simple trigonometry.”⁸⁹⁹

Carter and Sarfati fear that acceptance of a flat earth would require science “to go back centuries and reject just about everything we have learned about physics. This includes the great discoveries of Sir Isaac Newton.”⁹⁰⁰ What is one of the great Newtonian discoveries that Carter and Sarfati fear rejecting? They specifically list the theory of gravity. Carter and Sarfati do not want to reject the theory of gravity. These are two scientists who are clinging to a theory (gravity) which has never been proven, but to which they adhere as some kind of religious dogma. If the earth were flat, they would no longer have any need for gravity to

explain how things work. Indeed, Carter and Sarfati claim that “if the earth is flat, we cannot use physics [i.e., gravity] to explain how things work.”⁹⁰¹ If the earth is not a spinning globe, then the theory that explains why we do not fly off the globe due to centrifugal force is rendered a nullity. Carter and Sarfati cannot have that.

Carter and Sarfati state that we should “try to think of something that disproves a spherical Earth (if you can!).”⁹⁰² They cannot be serious! There is a truckload of scientific evidence and biblical authority that disproves a spherical earth, which is documented in this book. They seem to act as though the evidence does not exist, perhaps to hoodwink the reader who does not know about it. They tell the reader that as experts they have concluded that “the sphericity of the earth is one of the simplest aspects of operational science one could wish for.”⁹⁰³ They portray themselves as experts (they both proudly announce that they each hold Ph.D.’s) and so they must be held to the standard expected of experts. To do so, requires us to conclude that they are not simply mistaken in their conclusion regarding the sphericity of the earth, but that they are being purposely deceptive, as no expert who claims to have examined the biblical and scientific evidence could ever come to the conclusion that the earth is a sphere.

Carter and Sarfati state that “[i]n the case of the flat Earth, people have been fed a line of false reasoning that takes a while for some people to ‘unthink.’ With this in mind, we encourage people to put on their thinking caps and take a serious look at what the Bible and science have to say.”⁹⁰⁴ That sounds high-minded of Carter and Sarfati, but they do not practice what they preach. They point the reader to, of all organizations, NASA. That’s right; Carter and Sarfati, in part, support their theory of a spherical earth on propaganda from NASA. They tell the reader to believe NASA. What about their admonition to look put on our “thinking caps and take a serious look at what the Bible and science have to say?” They didn’t really mean that. What they really intend is for us to

shut up and believe what we have been told. Carter and Sarfati's double-mindedness is almost too much to take as they admonish the readers to think for themselves, but they then vouch for the credibility of NASA and tell us to trust and believe NASA:

The International Space Station has now gone around the earth over 100,000 times, carrying with it more than 220 different astronauts over the past 15 years. One astronaut, Col. Jeff Williams has recently returned from his fourth trip to space. Not only has Col. Williams set the record for cumulative days in space (534) but he is also an outspoken Christian! He and other astronauts have taken thousands of pictures and hundreds of hours of videos of the earth from space, many of which are available online. You can patch these together seamlessly to make a montage of the entire earth, and it is demonstrably a sphere. All of these scientists and astronauts are not lying!⁹⁰⁵

Carter and Sarfati want you to believe that NASA scientists and astronauts are not lying. But the fact is that NASA scientists and astronauts are lying, and so are Carter and Sarfati.

Creation Ministries International is just one of many examples of "Christian" ministries that have been carried away from Christ and spoiled by the rudiments of the world.

Beware lest any man spoil you through philosophy and vain deceit, after the tradition of men, after the rudiments of the world, and not after Christ. (Colossians 2:8)

Creationists are quite correct in attacking the scientific fraud of evolution and standing by the biblical authority for

creation. However, many of them seem to reject the scientific evidence and biblical authority for a geocentric, flat earth, which only serves to undermine the authority of the bible and, in turn, their credibility. Dr. Danny R. Faulkner exhibits the typical hypocrisy of many creationists who stand by the biblical authority for creation but reject that same biblical authority for a geocentric, flat earth. Dr. Faulkner taught at the University of South Carolina Lancaster for over 26 years. Dr. Faulkner is a member of the *Creation Research Society* (CRS) and also serves as the editor of the *Creation Research Society Quarterly*. He has written more than a hundred papers in various astronomy and astrophysics journals, and is author of *Universe by Design* and *The New Astronomy Book*.

How can a creation ministry accept the bible authority for creation but reject that same authority for a geocentric, flat earth? They use the devil inspired artifice of textual criticism. The CRS statement of belief is similar to that of the *Creation Ministries International*. The CRS statement of belief is that “the account of origins in Genesis is a factual presentation of simple historical truths.”⁹⁰⁶ However, the CRS guts the authority of scripture by limiting the inspired word of God to only being “historically and scientifically true in the **original autographs**.”⁹⁰⁷

With this artifice of looking for his biblical authority to “the original autographs,” which is a bible that no longer exists, Dr. Faulkner can embark on the duplicity of ignoring the clear meaning of bible passages by engaging in textual criticism of the English (Authorized King James Version) translation.

Some creationists believe that the scientific assault on the Bible did not begin with biological evolution, but with the acceptance of the heliocentric (or more properly, geokinetic) theory centuries ago. These people believe that the Bible clearly states that the Earth does not move, and

hence the only acceptable Biblical cosmology is a geocentric one. Modern geocentrists use both Biblical and scientific arguments for their case. ... Some geocentrists draw distinctions that do not exist in the original autographs or even in translations. ... Much of their case is based upon a misunderstanding of general relativity and the rejection of that theory. While geocentrists are well intended, their presence among recent creationists produces an easy object of ridicule by our critics.⁹⁰⁸ (parenthetical in original)

Dr. Faulkner points out the real issue: that the scientific assault on the bible began with heliocentrism. Faulkner is quick to point out, however, that he does not believe that heliocentrism is an attack on the bible. Faulkner relies on the devilish artifice of textual criticism to construct a belief that heliocentricity is consistent with what the bible says. He further relies for his authority on the bankrupt scientific theory of relativity. Faulkner concludes that geocentrism, particularly a belief in a flat earth, presents “an easy object of ridicule by our critics.” Faulkner seeks friendship with the world on heliocentrism in order to avoid the ridicule of critics. He does not abide by the admonition of God: “[K]now ye not that the friendship of the world is enmity with God? whosoever therefore will be a friend of the world is the enemy of God.” James 4:4. Dr. Faulkner, with his Ph.D., has great pride in his scholastic achievement. Therein lies the impediment to him accepting the truth of the geocentric, flat earth. He is quite frank in admitting that for him to do so would bring ridicule. His fear of ridicule is born of his “pride of life,” which is of the world and is contrary to God. “For all that is in the world, the lust of the flesh, and the lust of the eyes, and the pride of life, is not of the Father, but is of the world.” 1 John 2:16. Indeed, the devil knows the weak character of men and thus has conditioned people to have contempt and deride as an ignoramus anyone who believes the earth is flat. That heliocentric hive environment that zeros in on

and attacks a man's pride serves as an impediment to the truth of the geocentric, flat earth being accepted in academic and scientific circles.

What Faulkner does not see is that his adherence to heliocentricity and his failure to abide by the clear biblical authority for a geocentric, flat earth, in fact, undermines the credibility of the biblical argument for creation. For example, Glenn Elert, in his article, *The Scriptural Basis for a Geocentric Cosmology*, states that the bible clearly presents a flat earth that is immovable and lies at the center of all things.⁹⁰⁹ Elert rejects the authority of the bible and believes in both evolution and heliocentricity. Elert states that “[t]he purpose of this essay is to demolish the notion that the Bible has any scientific relevance whatsoever. In particular, I aim to show that the same thinking that leads devout fundamentalists to deny evolution as atheism must also lead them to embrace geocentrism and flat-earthism as God-given truths.”⁹¹⁰ On one point, Elert is correct; both creation and a geocentric, flat earth are supported by the bible. You simply cannot have one without the other. There is no lukewarm middle ground. “So then because thou art lukewarm, and neither cold nor hot, I will spue thee out of my mouth.” Revelation 3:16.

Elert then proceeds in his article to present bible passage after bible passage that clearly state that the earth is flat, stationary, and at the center of God's creation. Elert then eviscerates the credibility of the creationists who rely on the inerrant authority of scripture to support the truth of God's creation in a literal six days while they hypocritically dismiss the clear authority in the bible for a flat, stationary earth that is at the center of God's creation. Creationists, like Faulkner, erroneously think that they can stand firm having one foot in bible truth to refute evolution, while having the other foot in the quicksand of bible criticism and modern science eschewing a flat, stationary, geocentric earth. Elert is an example of how the heathen world uses creationists' own arguments that attack the biblical authority for a geocentric, flat

earth against creationists to undermine the biblical authority for creation. The obvious hypocrisy of adhering to the authority of the inerrant bible to refute evolution, while at the same time undermining the authority of that same bible when it speaks of a flat, stationary earth that is at the center of that creation, serves to reveal the modern creationists as double minded charlatans. Elert is thus forced to conclude:

The shocking truth of it all is that the pseudoscientific, anti-evolutionary forces have compartmentalized their literalism. There is a deafening silence among the aforementioned ranks when it comes to scientific theories other than the origin and evolution of life on earth. ... The message here is, I think, obvious. The Bible is the literal truth only when it's convenient and doesn't conflict with overwhelming evidence. In my view, this invalidates the core of the anti-evolutionary movement in its entirety. If the Bible is open to interpretation from time to time, then it is open to interpretation at any time. If the Bible is occasionally poetic, then it is possibly poetic at any time -- even on the first page, even on the last page, even on every page.⁹¹¹

Elert never addresses the true scientific evidence in support of a flat, stationary, geocentric earth, because neither he nor any other evolutionist are ever called on to do so by creationists. By yielding the field on heliocentricity, creationists have lost advantage of biblical authority before the battle even begins. Elert can get away with falsely saying that heliocentrism is supported by “overwhelming evidence,” because creationists accept that statement as true, and therefore do not try to refute the false claim. Elert then uses the very arguments of creationists against the bible truth of a geocentric, flat earth to bludgeon the hypocritical creationists. The creationists are portrayed as con

artists who use clever sophistry; this serves to undermine their argument for God's creation and, in turn, the authority of the bible.

The Satanic brainwashing to believe the heliocentric myth has been so effective that even the distinguished scientist and Christian minister Kent Hovind cannot overcome his conditioning. Kent Hovind has done wonderful work exposing the lies in school textbooks promoting the theory of evolution. Hovind has suffered terrible persecution at the hands of the government, even to the point of being sent to prison on false charges in order to stop him from his effective ministry against the evolutionary lies in the school textbooks. Hovind, however, continues to believe in a heliocentric system with a globular, spinning earth, orbiting the sun.

Hovind has been asked by Christians about the biblical model of a flat earth; he claims to have examined the matter and admonishes his followers to reject any notion of a flat earth. He views the flat earth as a "silly distraction from the gospel."⁹¹² What does Hovind rely upon as his authority for rejecting the flat earth? He refers his followers to "any earth science book."⁹¹³ Hovind hypocritically relies upon the authority of the very earth science books that he has proven to be full of lies promoting the myth of evolution in order to establish the validity of the supposed heliocentric model.

Søren Kierkegaard stated that "there are two ways to be fooled. One is to believe what isn't true; the other is to refuse to believe what is true." God states that "evil men and seducers shall wax worse and worse, deceiving, and being deceived." 2 Timothy 3:13. The so-called scientists that are pushing heliocentrism have been deceived and have in turn become deceivers themselves; they are fools who speak lies and refuse to believe the truth. "For the wisdom of this world is foolishness with God. For it is written, He taketh the wise in their own craftiness." (1 Corinthians 3:19) We are admonished to keep the faith and not join with those so-called

scientists who oppose God's word.

Remove Watermark Now

[K]eep that which is committed to thy trust, avoiding profane and vain babblings, and oppositions of science falsely so called: Which some professing have erred concerning the faith. Grace be with thee. Amen. (1 Timothy 6:20-21)

 pdfelement

Remove Watermark Now

 pdfelement

Endnotes

1. Anugrah Kumar, Christian Post, Christian Bakery Closed for Refusing Lesbian Wedding Cake Breaks Record on Crowdfunding Site With \$352,000, July 18, 2015.

2. Anugrah Kumar, Christian Post, Christian Bakery Closed for Refusing Lesbian Wedding Cake Breaks Record on Crowdfunding Site With \$352,000, July 18, 2015,
<http://www.christianpost.com/news/christian-bakery-closed-for-refusing-lesbian-wedding-cake-breaks-record-on-crowdfunding-site-with-352000-141657/#aORrHCwjl0oKMXVS.99>.

3. Todd Starnes, Fox News, Oregon Ruling Really Takes the Cake -- Christian Bakery Guilty of Violating Civil Rights of Lesbian Couple, January 21, 2014,
<http://www.foxnews.com/opinion/2014/01/21/christian-bakery-guilty-violating-civil-rights-lesbian-couple.html>.

4. Anugrah Kumar, Christian Post, Christian Bakery Closed for Refusing Lesbian Wedding Cake Breaks Record on Crowdfunding Site With \$352,000, July 18, 2015.

5. Todd Starnes, Fox News, Christian Bakers Face Government Wrath for Refusing to Make Cake for Gay Wedding, February 3, 2015,
<http://www.foxnews.com/opinion/2015/02/03/christian-bakers-face-government-wrath-for-refusing-to-make-cake-for-gay.html>.

6. Todd Starnes, Fox News, Christian Bakers Face Government Wrath for Refusing to Make Cake for Gay

Wedding, February 3, 2015,
<http://www.foxnews.com/opinion/2015/02/03/christian-bakers-face-government-wrath-for-refusing-to-make-cake-for-gay.html>.

7. Todd Starnes, Fox News, Christian Bakers Face Government Wrath for Refusing to Make Cake for Gay Wedding, February 3, 2015,
<http://www.foxnews.com/opinion/2015/02/03/christian-bakers-face-government-wrath-for-refusing-to-make-cake-for-gay.html>.

8. Todd Starnes, Fox News, Christian Bakers Face Government Wrath for Refusing to Make Cake for Gay Wedding, February 3, 2015,
<http://www.foxnews.com/opinion/2015/02/03/christian-bakers-face-government-wrath-for-refusing-to-make-cake-for-gay.html>.

9. Pentagon Manual Details Rules for Transgender Military Personnel, Fox News, July 19, 2016,
<http://www.foxnews.com/politics/2016/07/19/pentagon-manual-details-rules-for-transgender-military-personnel.html>.

10. Michael Swift's 1987 Gay Manifesto,
<http://www.blessedcause.org/protest/Gay%20Manifesto.htm>.

11. Steve Baldwin, Child Molestation and the Homosexual Movement, 14 REGENT L. REV. 267, 278 (2002),
http://www.mega.nu/ampp/baldwin_pedophilia_homosexuality.pdf.

12. Baldwin, *supra*, at 271, 278 citing W.D. Erickson et al., *Behavior Patterns of Child Molesters*, 17

ARCHIVES SEXUAL BEHAV., at 83 (1988).

13. Baldwin, *supra*, at 278.

14. Baldwin, *supra*, at 274.

15. Baldwin, *supra*, at 268.

16. Baldwin, *supra*, at 272-73, 277.

17. Baldwin at 272.

18. Reptilian Pets - Viewer Discretion Advised, Mar 8, 2016, at 8:15,

<https://www.youtube.com/watch?v=1YRuQ56Mie8>.

19. Bill Hoffmann, Tom DeLay: Justice Dept. Wants to Legalize 12 'Perversions', 30 June 2015, NEWSMAX, <http://www.newsmax.com/Newsmax-Tv/Tom-DeLay-Justice-Department-perversions/2015/06/30/id/652929/>.

20. The Friends of Charles Darwin, Marx of Respect, <http://friendsofdarwin.com/articles/marx/> (last visited on November 1, 2015).

21. Stamp, 150th Birth Anniversary of Charles Darwin, http://colnect.com/en/stamps/stamp/455245-150th_Birth_Anniversary_of_Charles_Darwin-Soviet_Union_US_SR (last visited on November 2, 2015).

22. Mark Edmundson, Defender of the Faith?, *The New York Times*, September 9, 2007, http://www.nytimes.com/2007/09/09/magazine/09wwln-lede-t.html?pagewanted=all&_r=0.

23. President George H.W. Bush, Address Before a Joint Session of the Congress on the State of the Union, January 29, 1991,

<http://www.presidency.ucsb.edu/ws/?pid=1253>.

24. Did Lenin say “a lie told often enough becomes the truth”?,

<http://skeptics.stackexchange.com/questions/32926/did-lenin-say-a-lie-told-often-enough-becomes-the-truth>
(last visited on December 8, 2016).

25. Samuel Birley Rowbotham (Parallax), *Zetetic Astronomy, Earth Not a Globe* (1881).

26. Samuel Birley Rowbotham (Parallax), *Zetetic Astronomy, Earth Not a Globe*, at 11-12 (1881).

27. Samuel Birley Rowbotham (Parallax), *Zetetic Astronomy, Earth Not a Globe*, at 12-13 (1881).

28. Samuel Birley Rowbotham (Parallax), *Zetetic Astronomy, Earth Not a Globe*, at 31 (1881).

29. Samuel Birley Rowbotham, A/K/A “Parallax,” *Zetetic Astronomy, The Earth is Not a Globe*, at 169-70 (1865),

30. Alexander Findlay, *Lighthouses of the World*, at 32 (1861).

31. Samuel Birley Rowbotham (Parallax), *Zetetic Astronomy, Earth Not a Globe*, at 28 (1881).

32. Samuel Birley Rowbotham (Parallax), *Zetetic Astronomy, Earth Not a Globe*, at 28-29 (1881).

33. Robert Schadewald, *Looking for Lighthouses*, Reprinted from *Creation/Evolution* #31 (1992), <https://www.lhup.edu/~dsimanek/litehous.htm>.

34. Robert Schadewald, Looking for Lighthouses,
Reprinted from Creation/Evolution #31 (1992),
<https://www.lhup.edu/~dsimanek/litehous.htm>.

35. Robert Schadewald, Looking for Lighthouses,
Reprinted from Creation/Evolution #31 (1992),
<https://www.lhup.edu/~dsimanek/litehous.htm>.

36. Robert Schadewald, Looking for Lighthouses,
Reprinted from Creation/Evolution #31 (1992),
<https://www.lhup.edu/~dsimanek/litehous.htm>.

37. Robert Schadewald, Looking for Lighthouses,
Reprinted from Creation/Evolution #31 (1992),
<https://www.lhup.edu/~dsimanek/litehous.htm>.

38. Bell Rock Lighthouse, <http://www.bellrock.org.uk/>
(last visited on October 15, 2015).

39. Alexander Findlay, Lighthouses of the World, at 44
(1861).

40. Alexander Findlay, Lighthouses of the World, at 32
(1861).

41. Fourteen Foot Bank Lighthouse, Lighthouse
Friends,
<http://www.lighthousefriends.com/light.asp?ID> (last
visited on October 16, 2015).

42. Fourteen Foot Bank Lighthouse, New Jersey
Lighthouse Society,
<http://www.njlhs.org/njlight/fourteen.html> (last visited
on October 16, 2015).

43. Fourteen Foot Bank Lighthouse, New Jersey
Lighthouse Society,
<http://www.njlhs.org/njlight/fourteen.html> (last visited

on October 16, 2015).

44. Joshua Nowicki,
<https://joshuanowicki.smugmug.com/search/?q=chicago&c=photos> (last visited on October 22, 2015).

45. Tom Coomes, Mirage of Chicago Skyline Seen from Michigan Shoreline, ABC 57 News, April 29, 2015,
<http://www.abc57.com/story/28925566/mirage-of-chicago-skyline-seen-from-michigan-shoreline>.

46. Tom Coomes, Mirage of Chicago Skyline Seen from Michigan Shoreline, ABC 57 News, April 29, 2015,
<http://www.abc57.com/story/28925566/mirage-of-chicago-skyline-seen-from-michigan-shoreline>.

47. Sjaak Slanina, Superior mirage, Encyclopedia of Earth, October 6, 2008,
<http://www.eoearth.org/view/article/156343/>.

48. Mirage Reveals Chicago Skyscrapers over Lake Michigan, WILX, April 23, 2015,
<http://www.wilx.com/news/headlines/Mirage-Reveals-Chicago-Skyscrapers-over-Lake-Michigan-301021881.html>.

49. Rossall Beach Residents and Community Group,
<http://www.rossallbeach.org.uk/iom.html> (last visited on November 12, 2015).

50. Distance From Rossall Beach, Wyre District, United Kingdom to Port Soderick, Isle of Man, 62.82 miles, <http://www.distancefromto.net/> (last visited on November 12, 2015).

51. Elevation Map of Rossall Beach, United Kingdom,
<http://elevationmap.net/rossall-beach-united-kingdom#menu2> (last visited on November 12, 2015).

52. Distance From Rossall Beach, Wyre District, United Kingdom to Snaefell, Isle of Man, 63.25 miles,
<http://www.distancefromto.net/> (last visited on November 12, 2015).

53. Rossall Beach Residents and Community Group,
<http://www.rossallbeach.org.uk/iom.html> (last visited on November 12, 2015).

54. Flat earth test, Part 1. Proof? Full HD,
https://www.youtube.com/watch?v=Ne_B4vqZ6oY
(last visited on October 14, 2015).

55. Tokitea, Washington State Department of Transportation,
http://www.wsdot.com/ferries/vesselwatch/VesselDetail.aspx?vessel_id=68 (last visited on October 15, 2015).

56. Flat Earth, Part 2. Proof ?, September 4, 2015,
<https://www.youtube.com/watch?v=eM2Tgjc528k>.

57. Corsica From Nervi (Genova), December 4, 2007,
Camera: Panasonic DMC-FZ10, Exposure: 0.040s (1/25), Focal Length: 72.00mm, F / Stop: f / 2,800, ISO Speed: ISO 200, Exposure Bias: 0.00 EV,
<http://www.panoramio.com/photo/10807454>.

58. The camera used was a Panasonic DMC-FZ10; the exposure was 0.040s (1/25); the focal length was 72.00mm; the F/Stop was f / 2,800; the ISO Speed was 200; and the exposure bias was 0.00 EV.
<http://www.panoramio.com/photo/10807454>.

59.U.S. Department of Homeland Security, UNITED STATES COAST GUARD, LIGHT LIST, Volume III, Atlantic and Gulf Coasts, Little River, South Carolina to Econfina River, Florida, (Includes Puerto Rico and the U.S. Virgin Islands), COMDTPUB P16502.3, U.S. Government Printing Office, Washington, DC 20402 (2015),
<http://www.navcen.uscg.gov/pdf/lightLists/LightList%20V3.pdf>.

60.U.S. Department of Homeland Security, UNITED STATES COAST GUARD, LIGHT LIST, Volume III, supra, at 4 (2015).

61.U.S. Department of Homeland Security, UNITED STATES COAST GUARD, LIGHT LIST, Volume III, supra, at vi (2015).

62.Water Finds Its Own Level, September 16, 2015,
<https://redrundrain.wordpress.com/2013/09/16/water-finds-its-own-level/>.

63.Eric Dubay, The Flat Earth Conspiracy, at 46 (2014).

64.David Wardlaw Scott, Terra Firma, at 134 (1901).

65.Samuel Rowbotham, Zetetic Astronomy, Earth Not a Globe!, at 54-55 (1881),
<http://www.sacred-texts.com/earth/za/za18.htm#page54>.

66.Samuel Rowbotham, Zetetic Astronomy, Earth Not a Globe!, at 54-55 (1881),
<http://www.sacred-texts.com/earth/za/za18.htm#page54>.

67.Samuel Rowbotham, Zetetic Astronomy, Earth Not a Globe!, at 54-55 (1881),
<http://www.sacred-texts.com/earth/za/za18.htm#page54>.

68.Samuel Rowbotham, Zetetic Astronomy, Earth Not a Globe!, at 54-55 (1881),
<http://www.sacred-texts.com/earth/za/za18.htm#page54>.

69.Samuel Rowbotham, Zetetic Astronomy, Earth Not a Globe!, at 55-56 (1881)
<http://www.sacred-texts.com/earth/za/za18.htm#page54>.

70.Samuel Rowbotham, Zetetic Astronomy, Earth Not a Globe!, at 55-56 (1881)
<http://www.sacred-texts.com/earth/za/za18.htm#page54>.

71.Mark Fonstad, William Pugatch, and Brandon Vogt, Kansas is Flatter Than a Pancake, Improbable Research, 2003,
<http://www.improbable.com/airchives/paperair/volume9/v9i3/kansas.html>.

72.Matt Sokiak, Is Kansas Really "Flatter than a Pancake"?, September 22, 2014,
<http://mentalfloss.com/article/58976/kansas-really-flatter-pancake>.

73.Matt Sokiak, Is Kansas Really "Flatter than a Pancake"?, September 22, 2014,
<http://mentalfloss.com/article/58976/kansas-really-flatter-pancake>.

74. Matt Sokiak, Is Kansas Really "Flatter than a Pancake"?, September 22, 2014, <http://mentalfloss.com/article/58976/kansas-really-flatter-pancake>.

75. Matt Sokiak, Is Kansas Really "Flatter than a Pancake"?, September 22, 2014, <http://mentalfloss.com/article/58976/kansas-really-flatter-pancake>.

76. Brendan Lynch, Research: If You Think Kansas Is the Flattest U.S. State, You're Plain Wrong, The University of Kansas, February 18, 2014, <https://news.ku.edu/2014/02/06/research-if-you-think-kansas-flattest-us-state-youre-plain-wrong>. Dobson, J. E., and J. S. Campbell. 2014. "The Flatness of U. S. States." *Geographical Review* 104(1):1-9.

77. Megan Garber, Science: Several U.S. States, Led by Florida, Are Flatter Than a Pancake, *The Atlantic*, March 11, 2014, <http://www.theatlantic.com/technology/archive/2014/03/science-several-us-states-led-by-florida-are-flatter-than-a-pancake/284348/>.

78. Kansans Flattered by Flatness vs Kansas Flatness Decriers, March 6, 2014, <http://www.improbable.com/2014/03/05/kansans-flattered-by-flatness-vs-kansas-flatness-decriers/>.

79. Jon McIntyre, Flat Earth ... A Mountain of Evidence, Sep 1, 2016, <https://www.youtube.com/watch?v=DPDtMQqlprk>.

80. Jon McIntyre, Flat Earth ... A Mountain of Evidence, at the 47:00 point in the video, Sep 1, 2016, <https://www.youtube.com/watch?v=DPDtMQqlprk>.

81. Jon McIntyre, Flat Earth ... A Mountain of Evidence, Sep 1, 2016,
<https://www.youtube.com/watch?v=DPDtMQqlprk>.

82. Debunked: View of Blue Ridge Mountains Impossible on Spherical Earth,
<https://www.metabunk.org/debunked-view-of-blue-ridge-mountains-impossible-on-spherical-earth.t7941/page-2>.

83. Debunked: View of Blue Ridge Mountains Impossible on Spherical Earth,
<https://www.metabunk.org/debunked-view-of-blue-ridge-mountains-impossible-on-spherical-earth.t7941/page-2>.

84. Rob Alphanostrum, Experiment which proves the flat earth or the round earth, May 6, 2016,
<https://www.youtube.com/watch?v=iixntrq8eu>.

85. Malcolm Bowden, Flat Earth Stupidity Exposed, February 5, 2016,
https://www.youtube.com/watch?v=nCh-tbTd_Pc&t=1053s.

86. Malcolm Bowden, Flat Earth Stupidity Exposed, February 5, 2016,
https://www.youtube.com/watch?v=nCh-tbTd_Pc&t=1053s.

87. Malcolm Bowden, Flat Earth Stupidity Exposed, February 5, 2016,
https://www.youtube.com/watch?v=nCh-tbTd_Pc&t=1053s.

88. Nick Berry, Consequences of Living on a Globe, DataGenetics,

<http://datagenetics.com/blog/june32012/index.html>
(last visited on December 25, 2016).

89. Nick Berry, Consequences of Living on a Globe, DataGenetics,
<http://datagenetics.com/blog/june32012/index.html>
(last visited on December 25, 2016).

90. Facts & Figures About the Bridge, Golden Gate Bridge Highway & Transportation District,
<http://goldengate.org/exhibits/facts-and-figures-about-the-bridge.php> (last visited on December 25, 2016).

91. Sarah L. Billington, David P. Billington, Jr., Engineering the Golden Gate, June 22, 2012,
https://www.curee.org/projects/GGB/conference/agenda_files/presentations-day2/10_History_of_Research-Billington.pdf.

92. E.g., D. B. Steinman, A.M., C.E., Ph.D., A Practical Treatise on Suspension Bridges, 1922,
<https://archive.org/details/practicaltreatis00steiuoft>.

93. Sumitomo Group Public Affairs Committee, Akashi Kaikyo Bridge and Advanced Technology,
http://www.sumitomo.gr.jp/english/discoveries/special/74_02.html (last visited on December 25, 2016).

94. North Tower Blueprints, Table of World Trade Center Drawings,
<http://911research.wtc7.net/wtc/evidence/plans/table.html>.

95. Ronald Hamburger, et al., FEMA 403, World Trade Center Building Performance Study (2002),
https://www.fema.gov/pdf/library/fema403_ch2.pdf.

96. Final Reports from the NIST World Trade Center Disaster Investigation, Final Reports Released in November 2005, and Final Report on the Collapse of World Trade Center Building 7, Released in November 2008,

<https://www.nist.gov/engineering-laboratory/final-reports-nist-world-trade-center-disaster-investigation>.

97. Tower Blueprints, Surviving Evidence of the World Trade Center Attack,

<http://911research.wtc7.net/wtc/evidence/blueprints.html#ref1> (last visited on December 31, 2016).

98. Tower Blueprints, Surviving Evidence of the World Trade Center Attack,

<http://911research.wtc7.net/wtc/evidence/blueprints.html#ref1> (last visited on December 31, 2016).

99. Ronald Hamburger, et al., FEMA 403, World Trade Center Building Performance Study (2002), Chapter 2, WTC1 and WTC2,

https://www.fema.gov/pdf/library/fema403_ch2.pdf.

100. Eric Dubay, The Flat Earth Conspiracy, at 46 (2014).

101. Brian Mullin, Official Launch! Force the Line Is On, July 16, 2016,

<https://www.youtube.com/watch?v=iu1t0jBBuTI>.

102. Brian Mullin, Official Launch! Force the Line Is On, July 16, 2016,

<https://www.youtube.com/watch?v=iu1t0jBBuTI>.

103. Brian Mullin, Official Launch! Force the Line Is On, July 16, 2016,

<https://www.youtube.com/watch?v=iu1t0jBBuTI>.

Comment by Yolanda Whittle.

104. Brian Mullin, Official Launch! Force the Line Is On, July 16, 2016,

<https://www.youtube.com/watch?v=iu1t0jBBuTI>.

Comment by Yolanda Whittle.

105. David Barnard Steiman, Levy Award, Engineering, The Design of the Mackinac Bridge, The Franklin Institute, 1957,

<https://www.fi.edu/laureates/david-barnard-steinman>.

106. E.g., D. B. Steinman, A.M., C.E., Ph.D., A Practical Treatise on Suspension Bridges, 1922,

<https://archive.org/details/practicaltreatis00steiuoft>.

107. Eric Dubay, The Flat Earth Conspiracy, at 46 (2014).

108. Target Generation Facility (TGF), Federal Aviation Administration, May 3, 2012,

<http://hf.tc.faa.gov/capabilities/tgf.htm>.

109. Target Generation Facility (TGF), Federal Aviation Administration, May 3, 2012,

<http://hf.tc.faa.gov/capabilities/tgf.htm>.

110. Mark Peters and Michael A. Konyak, The Engineering Analysis and Design of the Aircraft Dynamics Model For the FAA Target Generation Facility, Simulation Branch, Laboratory Services Division, Federal Aviation Administration, William J. Hughes Technical Center, October 2012, at 1, http://www.faa.gov/about/office_org/headquarters_offices/ang/offices/tc/about/campus/faa_host/labs/tgf/media/AircraftDynamicsModel.pdf.

111. Mark Peters and Michael A. Konyak, The Engineering Analysis and Design of the Aircraft Dynamics Model For the FAA Target Generation Facility, Simulation Branch, Laboratory Services Division, Federal Aviation Administration, William J. Hughes Technical Center, October 2012, at 32, http://www.faa.gov/about/office_org/headquarters_offices/ang/offices/tc/about/campus/faa_host/labs/tgf/media/AircraftDynamicsModel.pdf.

112. Peters and Konyak, The Engineering Analysis and Design of the Aircraft Dynamics Model For the FAA Target Generation Facility, *supra*, at 1-2.

113. Peters and Konyak, The Engineering Analysis and Design of the Aircraft Dynamics Model For the FAA Target Generation Facility, *supra*, at 2.

114. Peters and Konyak, The Engineering Analysis and Design of the Aircraft Dynamics Model For the FAA Target Generation Facility, *supra*, at 234.

115. Eugene Duke, Robert Antoniewicz, and Keith Krambeer, NASA Reference Publication 1207, Derivation and Definition of a Linear Aircraft Model, NASA Scientific and Technical Information Division, Ames Research Center, Dryden Flight Research Facility, 1988, https://www.nasa.gov/centers/dryden/pdf/88104main_H-1391.pdf.

116. United States Navy Training Film, Gyroscopes. See also United States Navy Training Film, FN-8048e, Instrument Flight Control, Gyroscopic Instruments Part II, 1960.

117.odiupicku, THE FLAT EARTH - A GYRO EXPERIMENT, November 12, 2015,
<https://www.youtube.com/watch?v=hlHOSUpmgQ8>.

118.Eric Dubay, The Flat Earth Conspiracy, at 35 (2014), quoting B. Chas. Brough, "The Zetetic" Volume 1 Number 1, July 1872.

119.Eric Dubay, The Always Horizontal Horizon Proves Earth Flat, January 14, 2015,
<http://www.atlanteanconspiracy.com/2015/01/flat-earth-horizon.html>, quoting Dr. Samuel Rowbotham, "Zetetic Astronomy, Earth Not a Globe!"

120.Samuel Birley Rowbotham (Parallax), Zetetic Astronomy, Earth Not a Globe, at 24-25 (1881),
http://www.sacred-texts.com/earth/za/za12.htm#page_25.

121.Samuel Birley Rowbotham (Parallax), Zetetic Astronomy, Earth Not a Globe, at 26-27 (1881),
http://www.sacred-texts.com/earth/za/za13.htm#page_26.

122.Eric Dubay, The Always Horizontal Horizon Proves Earth Flat, January 14, 2015,
<http://www.atlanteanconspiracy.com/2015/01/flat-earth-horizon.html>.

123.Samuel Birley Rowbotham, Zetetic Astronomy, Earth Not a Globe!, at 20 (1865).

124.Samuel Rowbotham, Zetetic Astronomy, Earth Not a Globe, at 40 (1881),
http://www.sacred-texts.com/earth/za/za16.htm#page_40.

125. Eric Dubay, The Always Horizontal Horizon Proves Earth Flat, January 14, 2015,
<http://www.atlanteanconspiracy.com/2015/01/flat-earth-horizon.html>.

126. NASA Unexplained Files 2015 Exposed Photo Expert Reveals PsyOp, October 23, 2015,
<https://www.youtube.com/watch?v=OeDhSbYsKXA>.
 See also BUSTED! - 2015 NASA Photo Fakery Revealed, September 27, 2015,
<https://www.youtube.com/watch?v=18IGhRt37pM>.

127. Tony Reichhardt, First Photo From Space, Air & Space Magazine, November 2006,
<http://www.airspacemag.com/space/the-first-photo-from-space-13721411/?no-ist>.

128. First Photo From Space, NASA,
<http://solarsystem.nasa.gov/planets/earth> (last visited on December 10, 2015).

129. Tony Reichhardt, First Photo From Space, Air & Space Magazine, November 2006,
<http://www.airspacemag.com/space/the-first-photo-from-space-13721411/?no-ist>.

130. Flat Earth View from 317 000 Feet - 96 Km (NASA Footage), December 1, 2015,
<https://www.youtube.com/watch?v=l7BhcufC-5Y>.

131. Gustave-Gaspard Coriolis, French physicist, Encyclopedia Britannica,
<http://www.britannica.com/biography/Gustave-Gaspard-Coriolis> (last visited on September 26, 2015).

132. Gustave-Gaspard Coriolis, French physicist, Encyclopedia Britannica, supra.

133. Coriolis Effect, National Geographic, <http://education.nationalgeographic.com/encyclopedia/coriolis-effect/> (last visited on September 26, 2015).

134. Mark Piggott, British Airways 777 Plane Blown Across Atlantic at Supersonic Speeds by Freak Jetstream, International Business Times, January 11, 2015, <http://www.ibtimes.co.uk/british-airways-777-plane-blown-across-atlantic-supersonic-speeds-by-freak-jetstream-1482875>.

135. David Wardlaw Scott, Terra Firma: The Earth Not a Planet Proved From Scripture, Reason, and Fact, 89-90 (1901).

136. Coriolis Effect, Coastal Practice Network, <http://www.coastalpractice.net/glossary/coriolis%20effect%20%20.htm> (last visited on October 26, 2015).

137. E.g., John J. McGrath, Fire for Effect: Field Artillery and Close Air Support in the U.S. Army, Combat Studies Institute Press, U.S. Army Combined Arms Center, Fort Leavenworth, Kansas.

138. E.g., Sniper Training, Field Manual, FM-2310, Headquarters, Department of the Army, 17 August 1994. See also U.S. Navy SEAL Sniper Training Program, Navy Special Warfare.

139. E.g., Colonel H.A. Bethel, Modern Artillery in the Field: A Description of the Artillery of the Field, A Description of the Artillery of the Field Army, and the Principles and Methods of Its Employment, 1911. See also Instruction for Field Artillery Prepared by a Board of Artillery Officers, 1860; Artillerist's Manual, Compiled from Various Sources and Adapted to The

Service of the United States, 1863; Joseph Roberts, The Hand-Book of Artillery, For the Service of the United States, (Army and Militia.) With the Manual of Heavy Artillery, Including That of the New Iron Carriage, 1863.

140. Georgia Diebelius, Caught on Camera: Amazing Moment a Woman Gives Birth to a Premature Baby Girl at 30,000ft on a Bali to Los Angeles Flight with Crew and Passengers Helping, Daily Mail, 13 October 2015,
http://www.dailymail.co.uk/travel/travel_news/article-3270382/Caught-camera-amazing-moment-woman-gives-birth-premature-baby-girl-30-000ft-Bali-Los-Angeles-flight-crew-passengers-helping-out.html.

141. Taiwanese Woman Gives Birth at 30,000 Feet on CAL Flight, October 12, 2015,
<http://www.chinapost.com.tw/taiwan/national/national-news/2015/10/12/448127/Taiwanese-woman.htm>.

142. Taiwanese Woman Gives Birth at 30,000 Feet on CAL Flight, October 12, 2015,
<http://www.chinapost.com.tw/taiwan/national/national-news/2015/10/12/448127/Taiwanese-woman.htm>.

143. Ben Mutzabaugh, Swiss Boeing 777 Diverts to Remote Arctic Canada, USA Today, February 3, 2017,
<http://www.usatoday.com/story/travel/flights/todayinthesky/2017/02/03/swiss-boeing-777-diverts-remote-arctic-canada/97439112/>.

144. Ben Mutzabaugh, USA Today, *supra*.

145. Ben Mutzabaugh, USA Today, *supra*.

146. Emirates Plane Flying from San Francisco to Dubai Makes Emergency Landing in Moscow, TASS Russian News Agency, November 20, 2016, <http://tass.com/society/913556>.

147. Flat Earth: Six Emergency Landings That Prove the Earth Is Flat, January 23, 2017, <https://www.youtube.com/watch?v=KzmjDFv23Ng>.

148. Laura Mowat, Flight Diverted After Teen Falls Into a Coma, Express, April 7, 2016, <http://www.express.co.uk/news/world/659059/Qatar-Airways-flight-Chicago-diverted-Moscow-teen-coma>.

149. Harriet Baskas, Cathay Pacific Blames Faulty Fan for Emergency Landing, USA Today, July 31, 2015, <http://www.usatoday.com/story/todayinthesky/2015/07/31/cathay-pacific-emergency-landing/30954955/>.

150. Sidereal Time, <http://www.astro.cornell.edu/academics/courses/astro201/sidereal.htm> (last visited on December 10, 2015).

151. Jerry Coffey, How Long is a Day on Earth?, June 3, 2008, <http://www.universetoday.com/14700/how-long-is-a-day-on-earth/>.

152. Sidereal Time, Cornell University Department of Astronomy, <http://www.astro.cornell.edu/academics/courses/astro201/sidereal.htm> (last visited on December 10, 2015).

153. How is this view of Earth's daily cycle similar to a clock?, Annenberg Learner, <http://www.learner.org/jnorth/tm/mclass/jr/LongNorthPoleAnimationAns.html> (last visited on December 10,

2015).

154. Now It's Your Turn: Self-Study Guide, University of California at Berkeley,
<http://cse.ssl.berkeley.edu/lessons/indiv/spin/selfstudy.html> (December 10, 2015).

155. Spin the Globe, University of Chicago Department of Astronomy and Astrophysics,
<http://astro.uchicago.edu/cara/southpole.edu/spin.html>
 (last visited on December 10, 2015).

156. Professor of Astronomy & Author Courtney Seligman, Rotation Period and Day Length, Online Astronomy eText: The Sky, March 3, 2015,
<http://cseligman.com/text/sky/rotationvsday.htm>.

157. Professor of Astronomy & Author Courtney Seligman, Rotation Period and Day Length, Online Astronomy eText: The Sky, March 3, 2015,
<http://cseligman.com/text/sky/rotationvsday.htm>.

158. Lesson 6.2 Start at the Source: Earth Rotating Around the Sun, Pennsylvania State University, The John A. Dutton e-Education Institute,
<https://www.e-education.psu.edu/meteo300/node/681>
 (last visited on November 2, 2015).

159. James I. Sammons, Navigating Around the World by Observing the Sun, Jamestown School Rhode Island,
<http://www.pbs.org/wgbh/nova/education/ideas/sammons/packet.html> (last visited on December 10, 2015).

160. Sidereal, Merriam-Webster Dictionary.

161. Justin Sink, Obama Mocks Skeptics of Climate Change as 'Flat-earth Society', The Hill, June 25,

2013,
[http://thehill.com/blogs/blog-briefing-room/news/307655-obama-we-don't-have-time-for-a-meeting-of-the-flat-earth-society](http://thehill.com/blogs/blog-briefing-room/news/307655-obama-we-don-t-have-time-for-a-meeting-of-the-flat-earth-society).

162.North Norway,
<http://www.norwaves.com/north-norway.html> (last visited on December 1, 2015).

163.Photographer, Amulf Husmo, describes the photograph as follows: "Time-lapse photography. Taken between July 21st, 1900 hrs and July 22nd, 1800 hrs. It is a 360 degrees panorama showing the sun's cycle North of the Arctic Circle. The location is the island of Loppa in Norway." Norway Midnight Sun Montage,
<http://www.gettyimages.com/detail/photo/norway-midnight-sun-high-res-stock-photography/290186-001>
 (last visited on December 1, 2015).

164.My Perspective, Flat earth and the Maze, March 9, 2015,
<https://www.youtube.com/watch?v=dADEYcXvFhI>.

165.Samuel Rowbotham, *Zetetic Astronomy*, at 91 (1865), citing "Astronomy and Astronomical Instruments," p. 105. By George G. Carey.

166.Samuel Rowbotham, *Zetetic Astronomy*, at 91 (1865), citing McCulloch's *Geography*, p. 85.

167.Samuel Rowbotham, *Zetetic Astronomy*, at 91 (1865), citing McCulloch's *Geography*, p. 85.

168.Samuel Rowbotham, *Zetetic Astronomy*, at 131 (1881). See "Daily Telegraph," July 16th, 1870.
<http://www.sacred-texts.com/earth/za/za29.htm#fr> 23.

169. Joe Rao, Total Lunar Eclipse On Wednesday Will Be a Rare 'Selenelion', October 5, 2014,
<http://www.space.com/27338-total-lunar-eclipse-rare-sunrise-selenelion.html>.

170. Joe Rao, Total Lunar Eclipse On Wednesday Will Be a Rare 'Selenelion', October 5, 2014,
<http://www.space.com/27338-total-lunar-eclipse-rare-sunrise-selenelion.html>.

171. Impossible "Selenelion" eclipse, Dec 2011,
<https://www.youtube.com/watch?v=jIyw6xuEJxk>,
uploaded December 10, 2011. See also Daytime Lunar Eclipse Footage Debunks The Ball Earth - The Flat Earth Reality,
<https://www.youtube.com/watch?v=xYCIIRXKiT4>,
published on July, 2016. Jenny Lea, Lunar Eclipse at Sunrise: Selenelion Viewed from Cahokia Mounds, December 14, 2011,
<https://www.youtube.com/watch?v=QUkjb4bbjpc>.

172. John Kees, Partial Lunar Eclipse, Madison Wisconsin 12-10-2011,
https://www.youtube.com/watch?v=mn6WrC_30IM.

173. Jenny Lea, Lunar Eclipse at Sunrise: Selenelion Viewed from Cahokia Mounds, December 14, 2011,
<https://www.youtube.com/watch?v=QUkjb4bbjpc>.

174. Jenny Lea, Lunar Eclipse at Sunrise: Selenelion Viewed from Cahokia Mounds, December 14, 2011,
<https://www.youtube.com/watch?v=QUkjb4bbjpc>.

175. Jenny Lea, Lunar Eclipse at Sunrise: Selenelion Viewed from Cahokia Mounds, December 14, 2011,
<https://www.youtube.com/watch?v=QUkjb4bbjpc>.

176. Jenny Lea, Lunar Eclipse at Sunrise: Selenelion
Viewed from Cahokia Mounds, December 14, 2011,
<https://www.youtube.com/watch?v=QUkjb4bbjpc>.

177. Jenny Lea, Lunar Eclipse at Sunrise: Selenelion
Viewed from Cahokia Mounds, December 14, 2011,
<https://www.youtube.com/watch?v=QUkjb4bbjpc>.

178. Samuel Rowbotham, *Zetetic Astronomy*, at 148
(1881),
http://www.sacred-texts.com/earth/za/za29.htm#fr_23.

179. Samuel Rowbotham, *Zetetic Astronomy*, at 149
(1881), quoting "Herschel's Astronomy," pp. 521 and
616,
http://www.sacred-texts.com/earth/za/za29.htm#fr_23.

180. Samuel Rowbotham, *Zetetic Astronomy*, at 149
(1881), quoting "Philosophical Magazine" for 1848, p.
80.

181. Samuel Rowbotham, *Zetetic Astronomy*, at 149
(1881), quoting "Encyclopædia Londinensis." Art.,
"Fixed Stars."

182. Samuel Rowbotham, *Zetetic Astronomy*, at 150-51
(1881).

183. Samuel Rowbotham, *Zetetic Astronomy*, at 136
(1881),
http://www.sacred-texts.com/earth/za/za29.htm#fr_23.

184. Samuel Rowbotham, *Zetetic Astronomy*, at 139-
141 (1881),
http://www.sacred-texts.com/earth/za/za29.htm#fr_23.

185. Samuel Rowbotham, *Zetetic Astronomy*, at 145
(1881),

<http://www.sacred-texts.com/earth/za/za29.html#1129>.

186."The Stevenson Effect" The Cold hard Truth
Moonlight is Cold" Flat earth VS Mandela Effect,
December 16, 2016,
<https://www.youtube.com/watch?v=DPi3n9br58M>.

187.Moon Light Test Results - Full Moon & New
Moon Compared, April 9, 2016,
https://www.youtube.com/watch?v=rSHs2_116JQ.

188.Does Moonlight Make You Cold? CONFIRMED!,
July 30, 2015,
https://www.youtube.com/watch?v=6uZ9B_iMG5k.

189.AMAZING!! - Moonlight Experiment -
Repeatable, July 2, 2015,
<https://www.youtube.com/watch?v=7sKe0POov-M&t=22s>.

190.Enno Logic eT650D Dual Laser Infrared
Thermometer.

191.R. Henry Noad, "Lectures on Chemistry," p. 334,
quoted in Samuel Rowbotham, Zetetic Astronomy, at
145 (1881).

192.Hey Bill Nye, "How Do We Know the Earth Is
Round?" #TuesdaysWithBill, May 24, 2016,
https://www.youtube.com/watch?v=3oz7k7Wn_vo.

193.Hey Bill Nye, "How Do We Know the Earth Is
Round?" #TuesdaysWithBill, May 24, 2016,
https://www.youtube.com/watch?v=3oz7k7Wn_vo.

194.Hey Bill Nye, "How Do We Know the Earth Is
Round?" #TuesdaysWithBill, May 24, 2016,
https://www.youtube.com/watch?v=3oz7k7Wn_vo.

195. Hey Bill Nye, "How Do We Know the Earth is Round?" #TuesdaysWithBill, May 24, 2016,
https://www.youtube.com/watch?v=3oz7k7Wn_vo.

196. Earth From Space: 15 Amazing Things in 15 Years, NASA, December 18, 2014,
<https://www.nasa.gov/content/goddard/earth-from-space-15-amazing-things-in-15-years>.

197. Elizabeth M. Jarrell, Lead Data Visualizer and Information Designer, Robert Simmon, Senior Program Analyst, Code 613, Climate and Radiation Branch, Earth Sciences Division, Sciences and Exploration Directorate, Conversations With Goddard, June 12, 2012,
<http://www.nasa.gov/centers/goddard/about/people/RSimmon.html> (last visited on May 8, 2016).

198. NASA Admits They Dont Use Real Images from Space, Dec 12, 2014,
https://www.youtube.com/watch?v=4p_0bnICtDc.

199. NASA Admits They Dont Use Real Images from Space, Dec 12, 2014,
https://www.youtube.com/watch?v=4p_0bnICtDc.

200. Elizabeth M. Jarrell, Lead Data Visualizer and Information Designer, Robert Simmon, Senior Program Analyst, Code 613, Climate and Radiation Branch, Earth Sciences Division, Sciences and Exploration Directorate, Conversations With Goddard, June 12, 2012,
<http://www.nasa.gov/centers/goddard/about/people/RSimmon.html> (last visited on May 8, 2016).

201. Earth - Apollo 16, Full Earth Showing North America and the Pacific Ocean, NASA,

http://nssdc.gsfc.nasa.gov/imgcat/html/object_page/a17_h_118_18885.html (last visited on October 31, 2015).

202. Conscious Truth, NASA Fake Images of Earth - Smoking Gun [Part 3], March 29, 2015,
<https://www.youtube.com/watch?v=kyzRNv3KJqE>.

203. Earth - Apollo 17, Full Earth Showing Africa and Antarctica, NASA,
http://nssdc.gsfc.nasa.gov/imgcat/html/object_page/a17_h_148_22725.html (last visited on October 31, 2015).

204. Conscious Truth, NASA Fake Images of Earth - Smoking Gun [Part 1], January 31, 2015.
<https://www.youtube.com/watch?v=35n9FLAoiA8>.

205. National Geospatial-Intelligence Agency, Mission,
<https://www.nga.mil/ProductsServices/Pages/default.aspx> (last visited on October 31, 2015).

206. Earth - Apollo 17, Full Earth showing Africa and Antarctica, NASA,
http://nssdc.gsfc.nasa.gov/imgcat/html/object_page/a17_h_148_22725.html (last visited on October 31, 2015).

207. Eric Hartwell's Infodabble,
<http://www.ehartwell.com/Apollo17/> (last visited on February 20, 2016).

208. Eric Hartwell's Infodabble,
<http://www.ehartwell.com/Apollo17/> (last visited on February 20, 2016).

209. Apollo 17 Image Library, last revised 14 December 2015,
<http://history.nasa.gov/alsj/a17/images17.html#MagN>
N.

210.The Blue Marble Explained,
[http://everything.explained.today/The Blue Marble/#
Ref-7](http://everything.explained.today/The+Blue+Marble/#Ref-7) (last visited on February 20, 2016).

211.Antonio Subirats, Flat Earth Slam Dunk! The Blue
Marble's Missing Continents, November 18, 2015,
https://www.youtube.com/watch?v=QtFvJtXu_jI.

212.Day and Night World Map,
[http://www.timeanddate.com/worldclock/sunearth.html
?month=12&day=7&year=1972&hour=10&min=39&s
ec=0&n=&ntxt=&earth=0](http://www.timeanddate.com/worldclock/sunearth.html?month=12&day=7&year=1972&hour=10&min=39&sec=0&n=&ntxt=&earth=0) (last visited on February 20,
2016).

213.NASA "Realist Artist" Contractor Exposes
Massive Lie of Heliocentrism, Matthew Boylan, Plane
Not a Planet, April 11, 2015,
<http://aplanetruth.info/tag/matthew-boylan/>.

214.NASA "Realist Artist" Contractor Exposes
Massive Lie of Heliocentrism, Matthew Boylan, Plane
Not a Planet, April 11, 2015,
<http://aplanetruth.info/tag/matthew-boylan/>.

215.NASA Captures "EPIC" Earth Image, July 20,
2015,
[https://www.nasa.gov/image-feature/nasa-captures-epic
-earth-image](https://www.nasa.gov/image-feature/nasa-captures-epic-earth-image).

216.NASA Captures "EPIC" Earth Image, July 20,
2015,
[https://www.nasa.gov/image-feature/nasa-captures-epic
-earth-image](https://www.nasa.gov/image-feature/nasa-captures-epic-earth-image).

217.Globe Skeptic, NASA Unexplained Files 2015
Exposed Photo Expert Reveals PsyOp, October 23,
2015,

<https://www.youtube.com/watch?v=OeDhSbYsKXA>.

218. Globe Skeptic, NASA Unexplained Files 2015 Exposed Photo Expert Reveals PsyOp, October 23, 2015,
<https://www.youtube.com/watch?v=OeDhSbYsKXA>.

219. NASA Captures "EPIC" Earth Image, July 20, 2015,
<https://www.nasa.gov/image-feature/nasa-captures-epic-earth-image>.

220. Blue Marble, 2012, January 25, 2012, NASA,
http://www.nasa.gov/multimedia/imagegallery/image_feature_2159.html.

221. Jeranism, Flat Earth Obama and Unfalsifiable "Science", Published on Apr 6, 2016,
https://www.youtube.com/watch?v=YqiiA4bOt_o&nohtml5=False.

222. WDTV Live 42 - Archive Footage, Apollo 10 "To Sort Out the Unknowns" - NASA Space Program & Moon Landings Documentary - WDTVLIVE42, uploaded to You Tube on November 8, 2011 ("This film has been made available thanks to NASA / courtesy of nasaimages.org"),
https://www.youtube.com/watch?v=R4_30-0YTO0.

223. WDTV Live 42 - Archive Footage, Apollo 10 "To Sort Out the Unknowns" - NASA Space Program & Moon Landings Documentary - WDTVLIVE42, uploaded to You Tube on November 8, 2011 ("This film has been made available thanks to NASA / courtesy of nasaimages.org"),
https://www.youtube.com/watch?v=R4_30-0YTO0.

224.Flat Earth Claims That Rocked My World (1 of 5),
October 20, 2015,
https://www.youtube.com/watch?v=FkjBx1f_OZ0.

225.Did We Go to the Moon? The NASA “Images”,
<http://aplanetruth.info/2015/03/05/6-how-did-we-go-to-the-moon-the-nasa-pictures/> (last visited on December 27, 2015).

226.Did We Go to the Moon? The NASA “Images”,
<http://aplanetruth.info/2015/03/05/6-how-did-we-go-to-the-moon-the-nasa-pictures/> (last visited on December 27, 2015).

227.Jack White's Apollo Studies – Index 1,
http://www.aulis.com/jackstudies_index1.html (last visited on December 27, 2015).

228.Jack White's Studies – Apollo 15 File,
http://www.aulis.com/jackstudies_11.html (last visited on December 27, 2015).

229.Jack White's Studies – Apollo 17 File,
http://www.aulis.com/jackstudies_19.html (last visited on December 27, 2015).

230.Jack White's Mystery of the Apollo Moonrovers,
http://www.aulis.com/jackstudies_23.html (December 27, 2015).

231.International Astronautical Federation, 1972:
Apollo 16 (NASA), March 8, 2009,
<https://www.youtube.com/watch?v=vsuBd0nUKZw>.

232.International Astronautical Federation, 1972:
Apollo 16 (NASA), March 8, 2009,
<https://www.youtube.com/watch?v=vsuBd0nUKZw>.

233. Apollo 16 Video Library,
<https://www.hq.nasa.gov/alsj/a16/video16.html#lrvdeply>
(last visited on January 3, 2016).

234. Ralph Renee, NASA Mooned America, at page c,
1994,
http://www.checktheevidence.com/pdf/Ralph%20Rene%20-%20NASA_mooned_america.pdf.

235. Ralph Renee, NASA Mooned America, at page d,
1994,
http://www.checktheevidence.com/pdf/Ralph%20Rene%20-%20NASA_mooned_america.pdf.

236. Ralph Renee, NASA Mooned America, at page d,
1994,
http://www.checktheevidence.com/pdf/Ralph%20Rene%20-%20NASA_mooned_america.pdf.

237. Ralph Renee, NASA Mooned America, at page d,
1994,
http://www.checktheevidence.com/pdf/Ralph%20Rene%20-%20NASA_mooned_america.pdf.

238. Jarrah White, Carrying The Fire, 1975 Edition,
December 17, 2007,
<https://www.youtube.com/watch?v=qIDYGsBmdeQ>.

239. Jarrah White, Carrying The Fire, 1975 Edition,
December 17, 2007,
<https://www.youtube.com/watch?v=qIDYGsBmdeQ>.
See also [Busted] NASA caught faking Gemini-10
Spacewalk Photos?,
<http://www.abovetopsecret.com/forum/thread482640/pg1>
(last visited on January 9, 2016).

240.Jarrah White, Carrying The Fire, 1975 Edition,
December 17, 2007,
<https://www.youtube.com/watch?v=qIDYGsBmdeQ>.

241.Russ Brown, Secret Moon - NASA Fake Moon
and Mars Hoax Proven,
<https://www.youtube.com/watch?v=iNxxzEIzDVU>.

242.Russ Brown, Secret Moon - NASA Fake Moon
and Mars Hoax Proven,
<https://www.youtube.com/watch?v=iNxxzEIzDVU>.

243.Brian Mullen, Ball's Out Physics Episode 5.0:
Propulsion in Space, April 1, 2016,
<https://www.youtube.com/watch?v=q8C0mStHdV0>.
Brian Mullen, Ball's Out Physics Episode 5.1:
Propulsion in a Vacuum Chamber, April 4, 2016,
<https://www.youtube.com/watch?v=Mq4fGmYoiqs>.

244.Snorkels in Space: Nasa's 'Macgyver' Solution to
Protect Spacewalking Astronauts, Fox News,
December 19, 2013,
<http://www.foxnews.com/science/2013/12/19/snorkels-in-space-macgyver-solution-to-protect-spacewalking-astronauts.html>.

245.Eric Dubay, ISS Hoax - The International Space
Station Does Not Exist!, February 1, 2015,
<https://www.youtube.com/watch?v=5e-RnKAN9qY>.
See also Steve Blakey, ISS Space Station Hoax Yes the
ISS and Pretty Much Everything Else to Do with
NASA, May 12, 2014,
<https://www.youtube.com/watch?v=Kgt3V-2xPFU>.

246.Lin Edwards, Moon Rock Turns Out To Be Fake,
September 1, 2009,
<http://phys.org/news/2009-09-moon-fake.html>.

247. Lin Edwards, Moon Rock Turns Out To Be Fake, September 1, 2009, <http://phys.org/news/2009-09-moon-fake.html>.

248. The fake Dutch moon rock and the Queen, October 9, 1969, Nieuwsblad van het Noorden, <http://www.awe130.com/apollo-hoax-explained/304-the-fake-dutch-moon-rock-and-the-queen>

249. The fake Dutch moon rock and the Prince, <http://www.awe130.com/apollo-hoax-explained/305-the-fake-dutch-moon-rock-and-the-prince> (last visited on December 28, 2015).

250. The fake Dutch moon rock and the Prince, <http://www.awe130.com/apollo-hoax-explained/305-the-fake-dutch-moon-rock-and-the-prince> (last visited on December 28, 2015).

251. Mary Bennett and David Percy, Dark Moon, Apollo and the Whistle-Blowers, at 268 (2001).

252. Documentary - Moon Landing Hoax - Conspiracy Theory - Part (1), <https://www.youtube.com/watch?v=Y5MVVtFYTS0> (last visited on January 4, 2016).

253. Astronaut Brian O'leary Is Not Entirely Convinced That the Apollo Program Succeeded, <http://www.clavius.org/oleary.html> (last visited on January 4, 2016). Quotations taken from a letter from Brian O'Leary, 29 August 2001, and from several letters in March 2009. All material used with his permission.

254. Astronaut Brian O'leary Is Not Entirely Convinced That the Apollo Program Succeeded,

<http://www.clavius.org/oleary.html> (last visited on January 4, 2016). Quotations taken from a letter from Brian O'Leary, 29 August 2001, and from several letters in March 2009. All material used with his permission.

255. Astronaut Brian O'leary Is Not Entirely Convinced That the Apollo Program Succeeded, <http://www.clavius.org/oleary.html> (last visited on January 4, 2016). Quotations taken from a letter from Brian O'Leary, 29 August 2001, and from several letters in March 2009. All material used with his permission.

256. Astronaut Brian O'leary Is Not Entirely Convinced That the Apollo Program Succeeded, <http://www.clavius.org/oleary.html> (last visited on January 4, 2016). Quotations taken from a letter from Brian O'Leary, 29 August 2001, and from several letters in March 2009. All material used with his permission.

257. Astronaut Brian O'leary Is Not Entirely Convinced That the Apollo Program Succeeded, <http://www.clavius.org/oleary.html> (last visited on January 4, 2016). Quotations taken from a letter from Brian O'Leary, 29 August 2001, and from several letters in March 2009. All material used with his permission.

258. Christopher Ruddy, Apollo Astronaut Was Murdered, February 4, 2000, http://www.theforbiddenknowledge.com/hardtruth/astro_naut_murdered.htm.

259. Why Did So Many Apollo Astronots Die Mysterious Deaths in Just Three Years Time?,

<http://aplanetruth.info/24-why-did-so-many-apollo-astronauts-die-mysterious-deaths-in-just-three-years-time/>
(last visited on January 6, 2016).

260. Bart Sibrel, Bill Kaysing Interview (Never Broadcast), April 14, 2013,
<https://www.youtube.com/watch?v=IJxHnpa90w4>.

261. Ralph Rene, NASA Mooned America!, at 49 (1994).

262. Christopher Ruddy, Apollo Astronaut Was Murdered, February 4, 2000,
http://www.theforbiddenknowledge.com/hardtruth/astro_naut_murdered.htm.

263. Christopher Ruddy, Apollo Astronaut Was Murdered, February 4, 2000,
http://www.theforbiddenknowledge.com/hardtruth/astro_naut_murdered.htm.

264. Christopher Ruddy, Apollo Astronaut Was Murdered, February 4, 2000,
http://www.theforbiddenknowledge.com/hardtruth/astro_naut_murdered.htm.

265. Bart Sibrel, Bill Kaysing Interview (Never Broadcast), April 14, 2013,
<https://www.youtube.com/watch?v=IJxHnpa90w4>.

266. Bart Sibrel, Bill Kaysing Interview (Never Broadcast), April 14, 2013,
<https://www.youtube.com/watch?v=IJxHnpa90w4>.

267. Bart Sibrel, Bill Kaysing Interview (Never Broadcast), April 14, 2013,
<https://www.youtube.com/watch?v=IJxHnpa90w4>.

268. Bart Sibrel, Bill Kaysing Interview (Never Broadcast), April 14, 2013,
<https://www.youtube.com/watch?v=IJxHnpa90w4>.

269. Ralph Rene, NASA Mooned America!, at 46 (1994).

270. Ralph Rene, NASA Mooned America!, at 49 (1994).

271. Ralph Rene, NASA Mooned America!, at 44 (1994).

272. Ralph Rene, NASA Mooned America!, at 49 (1994).

273. Ralph Rene, NASA Mooned America!, at 49 (1994).

274. Ralph Rene, NASA Mooned America!, at 44 (1994).

275. Ralph Rene, NASA Mooned America!, at 47 (1994).

276. Ralph Rene, NASA Mooned America!, at 47 (1994).

277. Amy Shira Teitel, The Apollo 1 Conspiracy Theory, Discover News, February 4, 2013,
<http://news.discovery.com/space/history-of-space/the-apollo-1-conspiracy-theory-130204.htm>.

278. Christopher Ruddy, Apollo Astronaut Was Murdered, February 4, 2000,
http://www.theforbiddenknowledge.com/hardtruth/astro_naut_murdered.htm.

279. Ralph Renee, NASA Mooned America!, at page 18, 1994, (1994).

280. Bart Sibrel, Bill Kaysing Interview (Never Broadcast), April 14, 2013,
<https://www.youtube.com/watch?v=IJxHnpa90w4>.

281. Bart Sibrel, Bill Kaysing Interview (Never Broadcast), April 14, 2013,
<https://www.youtube.com/watch?v=IJxHnpa90w4>.

282. Why Did So Many Apollo Astronauts Die Mysterious Deaths in Just Three Years Time?,
<http://aplanetruth.info/24-why-did-so-many-apollo-astronauts-die-mysterious-deaths-in-just-three-years-time/>
(last visited on January 6, 2016).

283. President Bush Offers New Vision For NASA, January 14, 2004,
http://www.nasa.gov/missions/solarsystem/bush_vision.html.

284. President Bush Offers New Vision For NASA, January 14, 2004,
http://www.nasa.gov/missions/solarsystem/bush_vision.html.

285. Ralph Renee, NASA Mooned America, at page 18, 1994,
http://www.checktheevidence.com/pdf/Ralph%20Rene%20-%20NASA_mooned_america.pdf.

286. Ralph Renee, NASA Mooned America, at page 18, 1994,
http://www.checktheevidence.com/pdf/Ralph%20Rene%20-%20NASA_mooned_america.pdf.

287.The Apollo 11 Telemetry Data Recordings: A Final Report,
https://www.hq.nasa.gov/alsj/a11/Apollo_11_TV_Tapes_Report.pdf (last visited on January 11, 2016).

288.The Apollo 11 Telemetry Data Recordings: A Final Report, at 13,
https://www.hq.nasa.gov/alsj/a11/Apollo_11_TV_Tapes_Report.pdf (last visited on January 11, 2016).

289.Brother Bart's Blog, Did We Walk on the Moon with 1960's Technology?,
<http://www.moontruth.org/bart/index.htm> (last visited on February 12, 2016). See also, Bart Sibrel, CRAPPY ANNIVERSARY: Did We Walk on the Moon 46 Years Ago With 1960's Technology? (VIDEOS), July 20, 2015,
<http://www.thesleuthjournal.com/land-moon-1960s-technology/>.

290.Russianvids, Ron Howard Says The 1969 Apollo 11 Moon Landing Was Faked In A Studio, April 9, 2016,
<https://www.youtube.com/watch?v=NyivxOiKuBs>.

291.Thomas W. Africa, Copernicus' relation to Aristarchus and Pythagoras, Isis, Vol. 52, No. 3. (Sep., 1961), pp. 403-409,
http://www.faculty.umb.edu/gary_zabel/Courses/Spinoza/Texts/Copernicus'%20Relation%20to%20Aristarchus%20and%20Pythagoras.pdf. Stable URL:
http://www.jstor.org/stable/228080?seq=1#page_scan_tab_contents.

292.Africa, at 403, citing J. Kepler, letter to Michael Mastlin, 11 June 1598, Gesammelte Werke, ed. Max Caspar (Munich: Beck'sche, 1955), XIII, 219.

293.Africa, at 404.

294.Africa, at 404.

295.Thomas W. Africa, Copernicus' relation to Aristarchus and Pythagoras, Isis, Vol. 52, No. 3. (Sep., 1961), pp. 403-409,
http://www.faculty.umb.edu/gary_zabel/Courses/Spinoza/Texts/Copernicus%20Relation%20to%20Aristarchus%20and%20Pythagoras.pdf. Stable URL:
http://www.jstor.org/stable/228080?seq=1#page_scan_tab_contents.

296.Jose Wudka, The Pythagoreans,
http://physics.ucr.edu/~wudka/Physics7/Notes_www/node32.html (last visited on December 8, 2016).

297.Jose Wudka, The Pythagoreans,
http://physics.ucr.edu/~wudka/Physics7/Notes_www/node32.html (last visited on December 8, 2016).

298.Eric Dubay, The Flat Earth Conspiracy, at 149 (2015).

299.Eric Dubay, The Flat Earth Conspiracy, at 149 (2015).

300.Eric Dubay, The Flat Earth Conspiracy, at 149 (2015).

301.Albert Mackey, Encyclopedia of Freemasonry,
http://www.phoenixmasonry.org/mackeys_encyclopedia/p.htm (last visited on January 1, 2016).

302.Jewish Encyclopedia, Cabala, at
<http://www.jewishencyclopedia.com/view.jsp?artid=1&letter=C#4> (last visited on April 18, 2010).

303. Jewish Encyclopedia, Cabala, at

<http://www.jewishencyclopedia.com/view.jsp?artid=1&letter=C#4> (last visited on April 18, 2010).

304. J. J. O'Connor and E. F. Robertson, Pythagoras of Samos,

<http://www-history.mcs.st-andrews.ac.uk/Biographies/Pythagoras.html> (last visited on December 8, 2016).

305. J. J. O'Connor and E. F. Robertson, Pythagoras of Samos,

<http://www-history.mcs.st-andrews.ac.uk/Biographies/Pythagoras.html> (last visited on December 8, 2016).

306. Jewish Encyclopedia, Cabala, at

<http://www.jewishencyclopedia.com/view.jsp?artid=1&letter=C#4> (last visited on April 18, 2010).

307. Jose Wudka, The Pythagoreans,

http://physics.ucr.edu/~wudka/Physics7/Notes_www/node32.html (last visited on December 8, 2016).

308. The Divine Origin of the Kabbalah, Jewish Alchemy: the Kabbalah,

http://www.alchemylab.com/jewish_alchemy.htm (last visited on January 5, 2016).

309. The Divine Origin of the Kabbalah, Jewish Alchemy: the Kabbalah,

http://www.alchemylab.com/jewish_alchemy.htm (last visited on January 5, 2016).

310. The Divine Origin of the Kabbalah, Jewish Alchemy: the Kabbalah,

http://www.alchemylab.com/jewish_alchemy.htm (last visited on January 5, 2016).

311. Johannes Reuchlin, The Wisdom of Kabbalah,
<http://www.kabbalah.info/eng/content/view/frame/80159?eng/content/view/full/80159&main> (last visited on January 5, 2016).

312. Johannes Reuchlin, The Wisdom of Kabbalah,
<http://www.kabbalah.info/eng/content/view/frame/80159?eng/content/view/full/80159&main> (last visited on January 5, 2016).

313. Johannes Reuchlin, The Wisdom of Kabbalah,
<http://www.kabbalah.info/eng/content/view/frame/80159?eng/content/view/full/80159&main> (last visited on January 5, 2016).

314. Albert Pike, *Morals and Dogma of the Ancient and Accepted Scottish Rite of Freemasonry*, P. 741 (1871).

315. Albert Mackey, *Encyclopedia of Freemasonry*,
http://www.phoenixmasonry.org/mackeys_encyclopedia/c.htm (last visited on January 1, 2016).

316. Martin L. Wagner, *Freemasonry: An Interpretation* (1912), available at
http://www.mindserpent.com/American_History/organization/mason/freemasonry/freemasonry.html.

317. Martin L. Wagner, *Freemasonry: An Interpretation*, at 182 (1912) available at
http://www.mindserpent.com/American_History/organization/mason/freemasonry/freemasonry.html.

318. MICHAEL A. HOFFMAN, *JUDAISM'S STRANGE GODS*, at p. 88, (2000).

319. MICHAEL A. HOFFMAN, *JUDAISM'S STRANGE GODS*, at p. 88, (2000). See also Michael Hoffman, *Judaism Discovered*, at 779 (2008) (quoting

Gershom Scholem, *Kabbalah* pp.183-84).

320. Protocols of the Learned Elders of Zion, Protocol 4,
<http://www.biblebelievers.org.au/przion3.htm#PROTOCOL%20No.%204> (last visited on August 31, 2012).
 See also Des Griffin, *Fourth Reich of the Rich*, p. 216 (1993).

321. Texe Marrs, *Masonic Jews Plot to Control World, Power of Prophecy*, April 2003,
http://www.texemarrs.com/masonic_jews_plot_world_control.htm (website address current as of April 4, 2003).

322. Texe Marrs, *Masonic Jews Plot to Control World, Power of Prophecy*, April 2003,
http://www.texemarrs.com/masonic_jews_plot_world_control.htm (website address current as of April 4, 2003).

323. Protocols of the Learned Elders of Zion, Protocol 15,
<http://www.biblebelievers.org.au/przion5.htm#protocol%20No.%2015> (last visited on August 25, 2012).

324. Protocols of the Learned Elders of Zion, Protocol 11,
<http://www.biblebelievers.org.au/przion4.htm#protocol%20No.%2011> (last visited on August 25, 2012).

325. Martin L. Wagner, *Freemasonry: An Interpretation*, at 113 (1912), quoting *Mystic Masonry*, pp. 119, 130, 138, 139, 140, available at http://www.mindserpent.com/American_History/organization/mason/freemasonry/freemasonry.html.

326.Martin L. Wagner, *Freemasonry: An Interpretation*, at 182 (1912), available at http://www.mindserpent.com/American_History/organization/mason/freemasonry/freemasonry.html.

327.Texe MARRS, *Masonic Jews Plot to Control World, Power of Prophecy*, April 2003, http://www.texemarrs.com/masonic_jews_plot_world_control.htm (website address current as of April 4, 2003).

328.Texe MARRS, *Masonic Jews Plot to Control World, Power of Prophecy*, April 2003, http://www.texemarrs.com/masonic_jews_plot_world_control.htm (website address current as of April 4, 2003).

329.Michael Hoffman, *Judaism Discovered*, at 768 (2008) (citing “The Place of Kabbalah in the Doctrine of Russian Freemasons,” in *Aries: Journal for the Study Western Esotericism*, vol. 4, no. 1 (Brill Academic 2004) and Heimbichner, *Blood on the Alter*).

330.Henry Makow, *Illuminati 2, Deceit and Seduction*, at 10 (2010).

331.Henry Makow, *Illuminati 2, Deceit and Seduction*, at 10 (2010).

332.Albert Pike, "Instructions to the 23 Supreme Councils of the World" (July 14, 1889), as recorded by Abel Clarin de La Rive, *La Femme et l'Enfant dans la Franc-Maçonnerie Universelle* (1894): 588, http://amazingdiscoveries.org/S-deception-Freemason_Lucifer_Albert_Pike#footnotevii. See also *Occult Theocracy*, pp. 220-21.

333. Albert Pike, *Morals and Dogma of the Ancient and Accepted Scottish Rite of Freemasonry Prepared for the Supreme Council of the Thirty-Third Degree, for the Southern Jurisdiction of the United States, and Published by Its Authority* (Richmond, Virginia: L.H. Jenkins, 1871, New and Revised Edition 1950), 321.

334. Manly Palmer Hall, "The Fellow Craft," *The Lost Keys of Freemasonry* (Richmond, Virginia: Macoy Publishing, 1931),
<http://www.manlyphall.org/text/the-lost-keys-of-freemasonry/chapter-iv-the-fellow-craft/>.

335. E.g., Lodge Copernicus No. 505, New Zealand; Lodge Copernicus No. 246, Australia.

336. *The Freemasons' Quarterly Review*, at 369 (1843).

337. *Freemasonry: When Man Reaches New Worlds, Masonry Will Be There*, July 19, 2009,
<http://www.conspiracyarchive.com/2013/12/01/freemasonry-when-man-reaches-new-worlds-masonry-will-be-there/>.

338. *The Story of Tranquility Lodge No. 2000, Chartered by The Grand Lodge of Texas, A.F. & A.M.*,
<http://tl2k.org/history.htm>.

339. *Buzz Aldrin Lies About His Masonic Activities on the Moon*, *Secret Societies*, August 18, 2009,
<http://www.conspiracyarchive.com/2013/12/03/buzz-aldrin-lies-about-his-masonic-activities-on-the-moon/>.
 See also, *Jeranism, We're Not in Kansas Anymore - FRAUD KINGS: NASA, BOLDEN, KELLY & GIFFORDS*, at 32:30, December 14, 2015,
<https://www.youtube.com/watch?v=H1AyU7jgKvE>.

340. The Dark Side of NASA, May 28, 2008,
http://primarysources.newsvine.com/_news/2008/05/28/1513441-the-dark-side-of-nasa.

341. 1979 10th Anniversary Our Flags on the Moon Medallion,
http://www.phoenixmasonry.org/masonicmuseum/sr_man_on_the_moon_medallion_1979.htm (last visited on December 31, 2015).

342. The Dark Side of NASA, May 28, 2008,
http://primarysources.newsvine.com/_news/2008/05/28/1513441-the-dark-side-of-nasa.

343. Science Proves that NASA Faked the Moon Landings - Moon Landing Hoax, December 6, 2012,
<https://www.youtube.com/watch?v=q7pzg9xpAOE&index=6&list=RDXtW72nT7cYQ>.

344. Science Proves that NASA Faked the Moon Landings - Moon Landing Hoax, December 6, 2012,
<https://www.youtube.com/watch?v=q7pzg9xpAOE&index=6&list=RDXtW72nT7cYQ>.

345. Edinburgh Encyclopedia (ed. David Brewster) (J.&E. Parker, 1832) Vol. II at 230,
<http://www.jesusbible.com/books/379-apollyon-bible-study.html>.

346. Wakeman Ryno, Amen: The God of the Amonians Or a Key to the Mansions in Heaven (Kessinger 2006), at 121,
<http://www.jesusbible.com/books/379-apollyon-bible-study.html>.

347. Texe Marrs, The Eagle Has Landed: Magic, Alchemy, and the Illuminati Conquest of Outer Space,

http://www.texemarrs.com/032003/eagle_has_landed.htm (last visited on January 2, 2015).

348.Nasa, The KJV Old Testament Hebrew Lexicon, <http://www.biblestudytools.com/lexicons/hebrew/kjv/nasa.html> (last visited on January 22, 2016).

349.Nasa, The KJV Old Testament Hebrew Lexicon, <http://www.biblestudytools.com/lexicons/hebrew/kjv/nasa.html> (last visited on January 22, 2016).

350.Shira Schoenberg & Mitchell Bard, Israel Science & Technology: NASA-Israel Collaboration, October 2015, <https://www.jewishvirtuallibrary.org/jsource/US-Israel/nasa.html>.

351.Shira Schoenberg & Mitchell Bard, Israel Science & Technology: NASA-Israel Collaboration, October 2015, <https://www.jewishvirtuallibrary.org/jsource/US-Israel/nasa.html>.

352.Shira Schoenberg & Mitchell Bard, Israel Science & Technology: NASA-Israel Collaboration, October 2015, <https://www.jewishvirtuallibrary.org/jsource/US-Israel/nasa.html>.

353.Shira Schoenberg & Mitchell Bard, Israel Science & Technology: NASA-Israel Collaboration, October 2015, <https://www.jewishvirtuallibrary.org/jsource/US-Israel/nasa.html>.

354.Bart Sibrel, Bill Kaysing Interview (Never Broadcast), April 14, 2013,

<https://www.youtube.com/watch?v=IJxHnpa90w4>.

355. Bart Sibrel, Bill Kaysing Interview (Never Broadcast), April 14, 2013,
<https://www.youtube.com/watch?v=IJxHnpa90w4>.

356. Bart Sibrel, Bill Kaysing Interview (Never Broadcast), April 14, 2013,
<https://www.youtube.com/watch?v=IJxHnpa90w4>.

357. Website Terms of Service, ProBoards,
<https://proboards.com/tos> (last visited on January 10, 2016).

358. Eric Dubay and IFERS Banned From the Internet, January 9, 2016, <http://www.atlanteanconspiracy.com/>.

359. Eric Dubay and IFERS Banned From the Internet, January 9, 2016, <http://www.atlanteanconspiracy.com/>.

360. Eric Dubay and IFERS Banned From the Internet, January 9, 2016, <http://www.atlanteanconspiracy.com/>.

361. John Whitley, *Seven Jewish American Control Most US Media*, Real News 24/7 (November 21, 2003), available at http://www.realnews247.com/seven_jewish_americans_control_media_rense.htm.

362. Id.

363. Id.

364. Id.

365. Guy Grimland, Facebook, Google Founders to Attend Jerusalem Conference in May, Ha'aretz 01/04/2008, cited in the Jewish Hand Behind Internet -

Google, Facebook, Wikipedia, Yahoo!, MySpace, eBay, Freedom Research, June, 2009,
http://www.fourwinds10.net/siterun_data/media/internet/news.php?q=1262024557.

366. Guy Rolnik, Google Founder Plans R&D Center in Israel, Ha'aretz 30/01/2006, cited in The Jewish Hand Behind Internet - Google, Facebook, Wikipedia, Yahoo!, MySpace, eBay, Freedom Research, June, 2009,
http://www.fourwinds10.net/siterun_data/media/internet/news.php?q=1262024557.

367. The Jewish Hand Behind Internet - Google, Facebook, Wikipedia, Yahoo!, MySpace, eBay, Freedom Research, June, 2009,
http://www.fourwinds10.net/siterun_data/media/internet/news.php?q=1262024557.

368. The Jewish Hand Behind Internet - Google, Facebook, Wikipedia, Yahoo!, MySpace, eBay, Freedom Research, June, 2009,
http://www.fourwinds10.net/siterun_data/media/internet/news.php?q=1262024557.

369. IFERS Forum Terminated/TFESSboards.net Activates!,
<http://aplanetruth.info/2015/12/30/ifers-forum-terminatedtfessboards-net-activates/> (last visited on January 11, 2016). See The Flat Earth Skeptic's Society forum at <http://tfess.proboards.com/forum> (last visited on January 11, 2016).

370. The Flat Earth Skeptic's Society,
<http://tfess.proboards.com/forum> (last visited on January 11, 2016).

371. Rob Skiba, *Folds, Yet Somehow this Only Pushes Me Further*, August 17, 2015,
<https://weseeasthroughaglassdarkly.wordpress.com/2015/08/17/rob-skiba-folds-yet-somehow-this-only-pushes-me-further/>.

372. Rob Skiba, *The Flat Earth Controversy: A Biblical World View And One Man's Quest For Truth*,
<http://testingtheglobe.com/> (last visited on January 10, 2016).

373. Rob Skiba, *The Flat Earth Controversy: A Biblical World View And One Man's Quest For Truth*,
<http://testingtheglobe.com/> (last visited on January 10, 2016).

374. Rob Skiba, *The Flat Earth Controversy: A Biblical World View And One Man's Quest For Truth*,
<http://testingtheglobe.com/> (last visited on January 10, 2016).

375. Rob Skiba, *The Flat Earth Controversy: A Biblical World View And One Man's Quest For Truth*,
<http://testingtheglobe.com/quest1.html> (last visited on March 16, 2016).

376. *Map Projections*, United States Geological Survey,
<http://egsc.usgs.gov/isb//pubs/MapProjections/projects.html> (last visited on November 2, 2015).

377. *Map Projections*, United States Geological Survey,
<http://egsc.usgs.gov/isb//pubs/MapProjections/projects.html> (last visited on November 2, 2015).

378. Eric Dubay, *The South Pole Does Not Exist*, *The Atlantean Conspiracy*, June 13, 2015, citing Greely, General A. W. "Antarctica, or the Hypothetical Southern Continent." *Cosmopolitan* 17 (1894): p. 296. See also *The Ice Wall*, [https://wiki.tfes.org/The Ice Wall](https://wiki.tfes.org/The_Ice_Wall), (Last visited on February 19, 2016), Photograph is used under a Creative Commons Attribution-Share Alike 4.0 International License.

379. *The Ice Wall*, [https://wiki.tfes.org/The Ice Wall](https://wiki.tfes.org/The_Ice_Wall), (Last visited on February 19, 2016).

380. Samuel Birley Rowbotham (Parallax), *Zetetic Astronomy, Earth Not a Globe* (1881), at 258, quoting from a book published by Gordon & Gotch, 85, Collins Street West, Melbourne, and 121, Holborn Hill, London.

381. Samuel Birley Rowbotham (Parallax), *Zetetic Astronomy, Earth Not a Globe* (1881), at 258, quoting from a book published by Gordon & Gotch, 85, Collins Street West, Melbourne, and 121, Holborn Hill, London.

382. Samuel Birley Rowbotham (Parallax), *Zetetic Astronomy, Earth Not a Globe* (1881), at 258-59.

383. Samuel Birley Rowbotham (Parallax), *Zetetic Astronomy, Earth Not a Globe* (1881), at 259, quoting "South Sea Voyages." By Sir J. C. Ross, p. 96, vol. i.

384. Samuel Birley Rowbotham (Parallax), *Zetetic Astronomy, Earth Not a Globe* (1881), at 260, quoting from a book published by Gordon & Gotch, 85, Collins Street West, Melbourne, and 121, Holborn Hill, London.

385.Samuel Birley Rowbotham (Parallax), *Zetetic Astronomy, Earth Not a Globe* (1881), at 260, quoting "The Builder." Sept. 20th, 1862.

386.Samuel Birley Rowbotham (Parallax), *Zetetic Astronomy, Earth Not a Globe* (1881), at 260-61, citing "South Sea Voyages." By Sir J. C. Ross, p. 96, vol. i.

387.The White House, *Inside the White House: The Situation Room*, December 18, 2009,
<https://www.youtube.com/watch?v=T7ch13ZuMu8>.

388.Can Christianity and Science Coexist?, ABC News, June 11, 2009,
<https://www.youtube.com/watch?v=M5sMva2ydoU>.

389.Compass, *American Dictionary of the English Language*, 1828,
<http://1828.mshaffer.com/d/word/compass>.

390.Image: Flat Earth versus Spherical Earth (Matthew 4 - 8 and Luke 4 - 5), for RW.PNG,
http://rationalwiki.org/wiki/File:Flat_Earth_versus_Spherical_Earth_%28Matthew_4_-_8_and_Luke_4_-_5%29,_for_RW.PNG. Copyright for image was released by its author into the public domain.

391.Corner, *American Dictionary of the English Language*, 1828,
<http://1828.mshaffer.com/d/word/corner> (last visited on December 23, 2015).

392.Corner, *American Dictionary of the English Language*, 1828,
<http://1828.mshaffer.com/d/word/corner> (last visited on December 23, 2015).

393. Corner, Webster's Revised Unabridged Dictionary (1913 + 1828),
<http://machaut.uchicago.edu/?resource=Webster%27s&word=corner&use1913=on> (last visited on December 23, 2015).

394. Corner, MacMillan Dictionary,
http://www.macmillandictionary.com/dictionary/american/corner_1#corner_20 (last visited on December 23, 2015).

395. Corner, Merriam Webster Dictionary,
<http://www.merriam-webster.com/dictionary/corner>
 (last visited on December 23, 2015).

396. Corner, Merriam Webster Dictionary,
<http://www.merriam-webster.com/dictionary/corner>
 (last visited on December 23, 2015).

397. SAMUEL C. GIPP, AN UNDERSTANDABLE HISTORY OF THE BIBLE, p. 70 (1987).

398. *Id.*

399. *Id.* at p. 71.

400. *Id.* at p. 70.

401. *Id.* at p. 71.

402. Samuel KJBB, Tares Among The Wheat (Sequel to "A Lamp in the Dark"), Published on April 29, 2014,
<https://www.youtube.com/watch?v=-aiHcghldjM&spfreload=5>.

403. Samuel KJBB, Tares Among The Wheat (Sequel to "A Lamp in the Dark"), Published on April 29,

2014,
<https://www.youtube.com/watch?v=-aiHcghIdjM&spfreload=5>.

404.Samuel KJBB, Tares Among The Wheat (Sequel to "A Lamp in the Dark"), Published on April 29, 2014,
<https://www.youtube.com/watch?v=-aiHcghIdjM&spfreload=5>.

405.Samuel KJBB, Tares Among The Wheat (Sequel to "A Lamp in the Dark"), Published on April 29, 2014,
<https://www.youtube.com/watch?v=-aiHcghIdjM&spfreload=5>.

406.*Id.* at p. 71.

407.*Id.*

408.*Id.* at p. 72.

409.LES GARRETT, WHICH BIBLE CAN WE TRUST?, p. 151 (1982).

410.G.A. RIPLINGER, NEW AGE BIBLE VERSIONS, p. 435 (1993).

411.SAMUEL C. GIPP, AN UNDERSTANDABLE HISTORY OF THE BIBLE, p. 116-130 (1987).

412.*Id.*

413.*Id.* at 126-29.

414.*Id.* at 131-68.

415.*Id.*

416.*Id.*

417.*Id.*

418.*Id.*

419.*Id.*

420.*Id.* at p. 405.

421.*Id.* at p. 400.

422.*Id.*

423.*Id.* at p. 406.

424.*Id.* at p. 432.

425.G. A. RIPLINGER, THE LANGUAGE OF THE KING JAMES BIBLE, p. 66 (1998).

426.*Id.* at p. 132 (quoting *Carlo Martini, In the Thick of the Ministry*, p. 42, the Liturgical Press, Collegeville, Minn., 1990).

427.G.A. RIPLINGER, BLIND GUIDES, p. 19.

428.G.A. RIPLINGER, BLIND GUIDES, p. 19.

429.Company History: Zondervan Corporation, <http://www.answers.com/topic/zondervan> (last visited on April 5, 2010).

430.G. A. RIPLINGER, THE LANGUAGE OF THE KING JAMES BIBLE, p. 114 (1998).

431.G.A. RIPLINGER, NEW AGE BIBLE VERSIONS, p. 2 (1993).

432.G. A. RIPLINGER, THE LANGUAGE OF THE KING JAMES BIBLE, p. 128 (1998).

433.Company History: Zondervan Corporation, <http://www.answers.com/topic/zondervan> (last visited on April 5, 2010).

434.Anton La Vey, Satanic Bible, Harper Collins, *available at* <http://www.harpercollins.com/book/index.aspx?isbn=9780380015399> (on sale 12/1/1976); NIV Bible, Harper Collins *available at* http://www.harpercollins.com/books/9780310949862/NIV_Bible/index.aspx.

435.G. A. RIPLINGER, THE LANGUAGE OF THE KING JAMES BIBLE, p. 128 (1998).

436.G. A. RIPLINGER, THE LANGUAGE OF THE KING JAMES BIBLE, p. 128 (1998).

437.Eric Dubay, The Flat Earth Conspiracy, at 114 (2014).

438.Eric Dubay, The Flat Earth Conspiracy, at 113-114 (2014).

439.David Wardlaw Scott, Terra Firma, at 8 (1901).

440.The Divine Origin of the Kabbalah, Jewish Alchemy: the Kabbalah, http://www.alchemylab.com/jewish_alchemy.htm (last visited on January 5, 2016).

441.The Divine Origin of the Kabbalah, Jewish Alchemy: the Kabbalah, http://www.alchemylab.com/jewish_alchemy.htm (last visited on January 5, 2016).

442. Sir Isaac Newton and the Jews, Jewish Currents, July 4, 2015, <http://jewishcurrents.org/july-5-sir-isaac-newton-and-the-jews-37605>.

443. Sir Isaac Newton and the Jews, Jewish Currents, July 4, 2015, <http://jewishcurrents.org/july-5-sir-isaac-newton-and-the-jews-37605>.

444. Sarah, Dry, Saving Isaac Newton: How a Jewish Collector Brought the Physicist's Papers to America, May 5, 2014, <http://www.tabletmag.com/jewish-arts-and-culture/books/170960/saving-isaac-newton>.

445. Sarah, Dry, Saving Isaac Newton: How a Jewish Collector Brought the Physicist's Papers to America, May 5, 2014, <http://www.tabletmag.com/jewish-arts-and-culture/books/170960/saving-isaac-newton>.

446. The Religious Background and Religious Beliefs of Albert Einstein, http://www.adherents.com/people/pe/Albert_Einstein.html, citing Dr. Arthur J. Deikman, who noted that Einstein echoed Isaac Newton's belief in the reality of the mystical (source: "A Functional Approach to Mysticism" in Journal of Consciousness Studies, Vol. 7, No. 11-12, November/December 2000; special issue: 'Cognitive Models and Spiritual Maps'; URL: <http://www.deikman.com/functional.html>).

447. Sarah, Dry, Saving Isaac Newton: How a Jewish Collector Brought the Physicist's Papers to America, May 5, 2014, <http://www.tabletmag.com/jewish-arts-and-culture/boo>

ks/170960/saving-isaac-newton.

448.Sarah, Dry, Saving Isaac Newton: How a Jewish Collector Brought the Physicist's Papers to America, May 5, 2014,
<http://www.tabletmag.com/jewish-arts-and-culture/books/170960/saving-isaac-newton>.

449.Sarah, Dry, Saving Isaac Newton: How a Jewish Collector Brought the Physicist's Papers to America, May 5, 2014,
<http://www.tabletmag.com/jewish-arts-and-culture/books/170960/saving-isaac-newton>.

450.Marshall Hall, Sola Scriptura - IV, Kabbala Phariseism or Bible Christianity?,
<http://www.fixedearth.com/sola-scriptura-4.html> (last visited on December 8, 2015).

451.Marshall Hall, Sola Scriptura - IV, Kabbala Phariseism or Bible Christianity?,
<http://www.fixedearth.com/sola-scriptura-4.html> (last visited on December 8, 2015).

452.Gershom Scholem, The Kabbalah, Meridian Books, New York 1978,
<http://www.mishkan.com/kbltalk1.html>.

453.Migene Gonzalez-Wippler, The Kabbalah & Magic of Angels, at 95-96 (2013).

454.Athol Bloomer, *The Eucharist and The Jewish Mystical Tradition • Part 1*, Association of Hebrew Catholics, at
<http://hebrewcatholic.org/PrayerandSpirituality/eucharistjewishm.html> (originally published in The Hebrew Catholic #77, pp 15-18 (Summer-Fall 2002)).

455. Athol Bloomer, *The Eucharist and The Jewish Mystical Tradition • Part 1*, Association of Hebrew Catholics, at <http://hebrewcatholic.org/PrayerandSpirituality/eucharistjewishm.html> (originally published in *The Hebrew Catholic* #77, pp 15-18 (Summer-Fall 2002)).

456. Athol Bloomer, *The Eucharist and The Jewish Mystical Tradition • Part 1*, Association of Hebrew Catholics, at <http://hebrewcatholic.org/PrayerandSpirituality/eucharistjewishm.html> (originally published in *The Hebrew Catholic* #77, pp 15-18 (Summer-Fall 2002)).

457. Rabbi Geoffrey W. Dennis, *The Encyclopedia of Jewish Myth, Magic, and Mysticism*, at 199 (2007), quoted by Michael Hoffman in *Judaism Discovered*, at 239-40 (2008).

458. Dennis, at 199.

459. Dan Cohn-Sherbok and Lavinia Cohn-Sherbok, *Jewish and Christian Mysticism: An Introduction*, at 167 (1994).

460. Rabbi Eli Mallon, M.Ed., LMSW, *Shir ha-Shirim: The Song of Songs*, April, 23, 2011, <http://rabbielimallon.wordpress.com/2011/04/23/4-23-11-shir-ha-shirim-the-song-of-songs/>, quoting, Schochet, J. Immanuel, transl. and ed.; *Tzva'at ha-Rivash (The Ethical Will of the Baal Shem Tov)*; section 68; Kehot Publication Society.

461. Rabbi Eli Mallon, M.Ed., LMSW, *Shir ha-Shirim: The Song of Songs*, April, 23, 2011, <http://rabbielimallon.wordpress.com/2011/04/23/4-23-11-shir-ha-shirim-the-song-of-songs/>.

462. Francis and the Shekinah, Call Me Jorge, May 29, 2014,
<http://callmejorgebergoglio.blogspot.com/2014/05/francis-shekinah.html>. See also, Brother Nathaniel Enlightens Us: Satan at the “Wailing Wall,”
<http://givingpsychologyaway.com/?tag=davening> and
<http://www.realjewnews.com/?p=798>.

463. Brother Nathaniel Kapner, Satan at the Wailing Wall, February 13, 2013,
<http://www.realjewnews.com/?p=798>.

464. Rabbi Michael Leo Samuel, Davening at Victoria’s Secret, San Diego Jewish Herald, 27 December 2013,
<http://www.sdjewishworld.com/2013/12/27/davening-at-victorias-secret/>, quoting Jacob I. Schochet, *Tzavat HaRivash* (Brooklyn, NY: Kehot Publication, 1998), pp.54-55.

465. Rabbi Michael Leo Samuel, Davening at Victoria’s Secret, San Diego Jewish Herald, 27 December 2013,
<http://www.sdjewishworld.com/2013/12/27/davening-at-victorias-secret/>, quoting Jacob I. Schochet, *Tzavat HaRivash* (Brooklyn, NY: Kehot Publication, 1998), pp.54-55.

466. Michael Hoffman, *Judaism Discovered*, at 239 (2008).

467. Michael Hoffman, *Judaism Discovered*, at 240 (2008).

468. Michael Hoffman, *Judaism Discovered*, at 240 (2008).

469. Moshe Idel, *Hasidism Between Ecstasy and Magic*, at 103.

470. Ithmar Gruenwald, *Israel Oriental Studies* 1 (1971); pp. 132-177 and *Temerin*, vol. 7 (Jerusalem, 1972) pp. 101-139. Gershom Scholem, *Jewish Gnosticism, Merkabah Mysticism and Talmudic Tradition* (Jewish Theological Seminary of America, 1965) cited by Michael Hoffman in *Judaism Discovered*, at 241 (2008).

471. Michael Hoffman, *Judaism Discovered*, at 241 (2008).

472. Tiferet, Jewish Virtual Library, at <http://www.jewishvirtuallibrary.org/jsource/Judaism/Tiferet.html> (last visited on March 2, 2010).

473. Tree of Life created by Friedhelm Wessel (25 October 2008), at http://commons.wikimedia.org/wiki/File:Tree_of_Life_%28Sefiroth%29.svg.

474. Laura Ellen Shulman, *Judaism, Jewish Mysticism Kabbalah and the Sefirot* (March 13, 2007), at <http://www.nvcc.edu/home/lshulman/Rel232/resource/sefirot.htm>.

475. MARSHAL HALL, *THE EARTH IS NOT MOVING*, p. 97 (1991)

476. GERARDUS BOUW, *GEOCENTRICITY*, p. 254-56 (1992).

477. Dr. Neville Thomas Jones, Ph.D., *Airy's Experiment*, <http://www.geocentricuniverse.com/Airy.htm> (last visited on August 24, 2012).

478.Malcolm Bowden, The Basic Scientific Arguments for Geocentricity,
<http://homepage.ntlworld.com/malcolmbowden/Geocentrism.html>.

479.Malcolm Bowden, The Basic Scientific Arguments for Geocentricity,
<http://homepage.ntlworld.com/malcolmbowden/Geocentrism.html>.

480.Gerrard Hickson, Kings Dethroned, at 60 (1922).

481.Herbert Dingle, Science at the Crossroads (1972), at 114.

482.Malcolm Bowden, Geocentricity is Scientific, Heliocentricity is a Lie!, December 28, 2014,
<https://www.youtube.com/watch?v=bxMSL9h2ziY>.

483.Herbert Dingle, Science at the Crossroads (1972), at 108.

484.Nikola Tesla,
<http://www.brainyquote.com/quotes/quotes/n/nikolatesla1401270.html> (last visited on September 9, 2015).

485.New York Times, 11 July 1935, p23, c.8.

486.Herbert Dingle, Science at the Crossroads (1972), at 14,
http://blog.hasslberger.com/Dingle_SCIENCE_at_the_Crossroads.pdf.

487.Herbert Dingle, Science at the Crossroads (1972), at 16,
http://blog.hasslberger.com/Dingle_SCIENCE_at_the_Crossroads.pdf.

488. Herbert Dingle, *Science at the Crossroads* (1972), at 5,
http://blog.hasslberger.com/Dingle_SCIENCE_at_the_Crossroads.pdf.

489. Herbert Dingle, *Science at the Crossroads* (1972), at 18,
http://blog.hasslberger.com/Dingle_SCIENCE_at_the_Crossroads.pdf.

490. Herbert Dingle, *Science at the Crossroads* (1972), at 18,
http://blog.hasslberger.com/Dingle_SCIENCE_at_the_Crossroads.pdf.

491. Herbert Dingle, *Science at the Crossroads* (1972), at 64,
http://blog.hasslberger.com/Dingle_SCIENCE_at_the_Crossroads.pdf.

492. Marshal Hall, *The Earth is Not Moving*, at 117 (1991), (quoting Ronald W. Clark, *Einstein: The Life and Times*, at 87 (1971)).

493. Herbert Dingle, *Science at the Crossroads* (1972), at 5,
http://blog.hasslberger.com/Dingle_SCIENCE_at_the_Crossroads.pdf.

494. N. Martin Gwynne, *Einstein and Modern Physics*, at 11, <http://www.alcazar.net/einstein.pdf> (last visited on October 6, 2015).

495. Herbert Dingle, *Science at the Crossroads* (1972), at 6,
http://blog.hasslberger.com/Dingle_SCIENCE_at_the_Crossroads.pdf.

496. Herbert Dingle, *Science at the Crossroads* (1972), at 7, http://blog.hasslberger.com/Dingle_SCIENCE_at_the_Crossroads.pdf.

497. Herbert Dingle, *Science at the Crossroads* (1972), at 33.

498. Michelson-Morley Experiment, World Heritage Encyclopedia, http://self.gutenberg.org/articles/Michelson-Morley_experiment (last visited on October 28, 2016).

499. Gerrard Hickson, *Kings Dethroned*, at 65 (1922).

500. Gerrard Hickson, *Kings Dethroned*, at 65 (1922).

501. N. Martin Gwynne, *Einstein and Modern Physics*, at 3, <http://www.alcazar.net/einstein.pdf> (last visited on October 6, 2015).

502. N. Martin Gwynne, *Einstein and Modern Physics*, at 31, <http://www.alcazar.net/einstein.pdf> (last visited on October 6, 2015).

503. N. Martin Gwynne, *Einstein and Modern Physics*, at 31-32, <http://www.alcazar.net/einstein.pdf> (last visited on October 6, 2015).

504. N. Martin Gwynne, *Einstein and Modern Physics*, at 32, <http://www.alcazar.net/einstein.pdf> (last visited on October 6, 2015).

505. N. Martin Gwynne, *Einstein and Modern Physics*, at 3-4, <http://www.alcazar.net/einstein.pdf> (last visited on October 6, 2015).

506.N. Martin Gwynne, Einstein and Modern Physics, at 5, <http://www.alcazar.net/einstein.pdf> (last visited on October 6, 2015).

507.N. Martin Gwynne, Einstein and Modern Physics, at 5-6, <http://www.alcazar.net/einstein.pdf> (last visited on October 6, 2015).

508.Malcolm Bowden, Geocentricity is Scientific, Heliocentricity is a Lie!, December 28, 2014, <https://www.youtube.com/watch?v=bxMSL9h2ziY>. See also, Jeroen van Dongen, *infra*.

509.Malcolm Bowden, Geocentricity is Scientific, Heliocentricity is a Lie!, December 28, 2014, <https://www.youtube.com/watch?v=bxMSL9h2ziY>, citing Ronald W. Clark, Einstein, The Life and Times, at 80 (1971).

510.Jeroen van Dongen, On the role of the Michelson-Morley experiment: Einstein in Chicago, Institute for History and Foundations of Science & Descartes Centre, Utrecht University & Einstein Papers Project, Caltech, http://philsci-archive.pitt.edu/4778/1/Einstein_Chicago_Web2.pdf (last visited on October 6, 2015).

511.Jeroen van Dongen, *supra* (quoting Einstein to Michelson's biographer, Bernard Jaffe, on 17 March 1942; as in (Holton 1969/1995), p. 340.).

512.Jeroen van Dongen, *supra*.

513.Albert Einstein, How I Created the Theory of Relativity, Translated by Yoshimasa A. Ono, Physics Today, Vol. 35, No.8, pp. 45-47, August 1982, <http://citeseerx.ist.psu.edu/viewdoc/download?doi=10.>

1.1.451.9501&rep=rep1&type=pdf.

514.Danian Hu, China and Albert Einstein, Harvard University Press, at 85 (2005).

515.Albert Einstein, How I Created the Theory of Relativity, Translated by Yoshimasa A. Ono, Physics Today, Vol. 35, No.8, pp. 45-47, August 1982, <http://citeseerx.ist.psu.edu/viewdoc/download?doi=10.1.1.451.9501&rep=rep1&type=pdf>.

516.Jeroen van Dongen, supra.

517.Jeroen van Dongen, supra.

518.Frederic Golden, Einstein, Time, December 31, 1999, <http://content.time.com/time/magazine/article/0,9171,993017,00.html>.

519.ANTHONY C. SUTTON, AMERICA'S SECRET ESTABLISHMENT, AN INTRODUCTION TO THE ORDER OF SKULL & BONES, at p. 212 (1986).

520.ANTHONY C. SUTTON, AMERICA'S SECRET ESTABLISHMENT, AN INTRODUCTION TO THE ORDER OF SKULL & BONES, at p. 212 (1986).

521.ANTHONY C. SUTTON, AMERICA'S SECRET ESTABLISHMENT, AN INTRODUCTION TO THE ORDER OF SKULL & BONES, at p. 7 (1986).

522.ANTHONY C. SUTTON, AMERICA'S SECRET ESTABLISHMENT, AN INTRODUCTION TO THE ORDER OF SKULL & BONES, at p. 200 (1986).

523.David Bay, Secret Societies Killed Jesus Christ, www.cuttingedge.org

http://home.talkcity.com/InspirationAv/jforjesus/secret_societies.html (current as of October 1, 2001).

524. George H.W Bush, Address Before a Joint Session of the Congress on the State of the Union, January 29, 1991, The American Presidency Project, University of California,
<http://www.presidency.ucsb.edu/ws/?pid=19253>.

525. M.S. King, The Bad War, The Truth Never Taught About World War II, at 155 (2015). See also NEW WORLD ORDER PLEDGED TO JEWS; Arthur Greenwood of British War Cabinet Sends Message of Assurance Here RIGHTING OF WRONGS SEEN English Rabbi Delivers to Dr. S.S. Wise New Statement on Question After War, The New York Times, October 6, 1940,
<http://query.nytimes.com/gst/abstract.html?res=9B03EFDC1639E23ABC4E53DFB667838B659EDE>.

526. M.S. King, The Bad War, The Truth Never Taught About World War II, at 155 (2015). See also NEW WORLD ORDER PLEDGED TO JEWS; Arthur Greenwood of British War Cabinet Sends Message of Assurance Here RIGHTING OF WRONGS SEEN English Rabbi Delivers to Dr. S.S. Wise New Statement on Question After War, The New York Times, October 6, 1940,
<http://query.nytimes.com/gst/abstract.html?res=9B03EFDC1639E23ABC4E53DFB667838B659EDE>.

527. Herbert Dingle, Science at the Crossroads (1972), at 19.

528. Letter Offering Albert Einstein the Presidency of Israel, Embassy of Israel, November 17, 1952, Jewish

Virtual Library,

<https://www.jewishvirtuallibrary.org/jsourc/Politics/einsteinlet.html>.

529. Protocols of the Learned Elders of Zion, Protocol 2,

<http://www.biblebelievers.org.au/przion2.htm#PROTOCOL%20No.%202> (Last visited on August 22, 2012).

530. Ivan Fraser, The Protocols of the Learned Elders of Zion: Proofs of an Ancient Conspiracy, quoting The American Bulletin, May 5, 1935,

http://www.bibliotecapleyades.net/sociopolitica/esp_sociopol_zion04.htm (last visited on October 17, 2012).

531. Ivan Fraser, The Protocols of the Learned Elders of Zion: Proofs of an Ancient Conspiracy, quoting The American Bulletin, May 5, 1935,

http://www.bibliotecapleyades.net/sociopolitica/esp_sociopol_zion04.htm (last visited on October 17, 2012).

532. MICHAEL A. HOFFMAN II, JEWISH COMMUNISTS: THE DOCUMENTARY RECORD, <http://www.hoffman-info.com/communist.html> (website current as of March 5, 2003) (citing N.Y. Times, Oct. 7, 1999 and Newsweek, Oct. 18, 1999, p. 30).

533. New World Encyclopedia,

http://www.newworldencyclopedia.org/entry/Comintern#cite_note-0 (last visited on September 19, 2012) (citing MI-5, History, The Inter-War Period. Retrieved December 19, 2007).

534. Henry Makow, Illuminati: The Cult That Hijacked the World, at 56 (2011).

535.MICHAEL A. HOFFMAN II, JEWISH COMMUNISTS: THE DOCUMENTARY RECORD, <http://www.hoffman-info.com/communist.html> (website current as of March 5, 2003).

536.MICHAEL A. HOFFMAN II, JEWISH COMMUNISTS: THE DOCUMENTARY RECORD, <http://www.hoffman-info.com/communist.html> (website current as of March 5, 2003) (quoting Dmitri Volkogonov, *Lenin: A New Biography*, p. 112).

537.MICHAEL A. HOFFMAN II, JEWISH COMMUNISTS: THE DOCUMENTARY RECORD, <http://www.hoffman-info.com/communist.html> (website current as of March 5, 2003).

538.ROBERT WILTON, THE LAST DAYS OF THE ROMANOV'S (1920).

539.Gordon "Jack" Mohr, The Talmudic Effect on Judeo-Christianity, <http://www.christianbiblestudy.org/OPS/JM/jm0027c.htm> (current as of September 19, 2001).

540.ROBERT WILTON, THE LAST DAYS OF THE ROMANOV'S, p. 148 (1920).

541.COLONEL GORDON "JACK" MOHR, THE TALMUDIC EFFECT ON JUDEO-CHRISTIANITY, <http://www.christianbiblestudy.org/OPS/JM/jm0027e.htm> (current as of September 17, 2001).

542.*Izvestia*, July 27, 1918.

543.HENRY FORD, THE INTERNATIONAL JEW, vol. 1, p. 225 (1920).

544.HENRY FORD, THE INTERNATIONAL JEW,
vol. 1, p. 225 (1920).

545.MICHAEL A. HOFFMAN II, JEWISH
COMMUNISTS: THE DOCUMENTARY RECORD,
<http://www.hoffman-info.com/communist.html>
(website current as of March 5, 2003) (quoting The
Christian News, Jan. 8, 1996, p. 2).

546.MICHAEL A. HOFFMAN II, JEWISH
COMMUNISTS: THE DOCUMENTARY RECORD,
<http://www.hoffman-info.com/communist.html>
(website current as of March 5, 2003).

547.Henry Makow, Communism - A Ruse for
Illuminati Jewish Theft & Murder, April 28, 2008,
http://www.savethemales.ca/communism_disguises_illuminati.html.

548.Slava Katamidze, Loyal Comrades, Ruthless
Killers -The Secret Services of the USSR 1917-1991,
at 25, quoted by Henry Makow, Communism - A Ruse
for Illuminati Jewish Theft & Murder, April 28, 2008,
http://www.savethemales.ca/communism_disguises_illuminati.html.

549.Henry Makow, Communism - A Ruse for
Illuminati Jewish Theft & Murder, April 28, 2008,
http://www.savethemales.ca/communism_disguises_illuminati.html.

550.Henry Makow, Communism - A Ruse for
Illuminati Jewish Theft & Murder, April 28, 2008,
http://www.savethemales.ca/communism_disguises_illuminati.html.

551. Sever Plocker, Stalin's Jews, December 26, 2000,
<http://www.ynetnews.com/articles/0,7340,L-3342999,00.html>.

552. DES GRIFFIN, FOURTH REICH OF THE RICH,
 p. 62 (1976).

553. *Id.*

554. Protocols of the Learned Elders of Zion, Protocol
 3,
<http://www.biblebelievers.org.au/przion2.htm#PROTOCOL%20No.%203> (last visited on October 17, 2012).

555. DONN DE GRAND PRE, BARBARIANS
 INSIDE THE GATES, THE BLACK BOOK OF
 BOLSHEVISM, p. 209 (2000) (quoting BEJAMIN
 FREEDMAN, FACTS ARE FACTS (1954)).

556. Baruch Levy, Letter to Karl Marx, 'La Revue de
 Paris', p. 574, June 1, 1928.

<http://www4.stormfront.org/posterity/ci/tjg.html>
 (current as of September 9, 2001). *See also*

DON DE GRAND PRE, BARBARIANS INSIDE
 THE GATES, p. 64 (2000).

557. DONN DE GRAND PRE, BARBARIANS
 INSIDE THE GATES, THE BLACK BOOK OF
 BOLSHEVISM, p. 313-14 (2000) (citing JACK
 BERNSTEIN, THE LIFE OF AN AMERICAN JEW
 IN RACIST MARXIST ISRAEL (1984)).

558. DONN DE GRAND PRE, BARBARIANS
 INSIDE THE GATES, THE BLACK BOOK OF
 BOLSHEVISM, p. 313-14 (2000) (citing JACK
 BERNSTEIN, THE LIFE OF AN AMERICAN JEW
 IN RACIST MARXIST ISRAEL (1984)).

559.DONN DE GRAND PRE, BARBARIANS INSIDE THE GATES, THE BLACK BOOK OF BOLSHEVISM, p. 313-14 (2000) (citing JACK BERNSTEIN, THE LIFE OF AN AMERICAN JEW IN RACIST MARXIST ISRAEL (1984)).

560.JACK BERNSTEIN, MY FAREWELL TO ISRAEL THE THORN IN THE MIDEAST.

561.See John S. Torell, Showdown in Jerusalem, The Dove, winter 1995.

562.Walter White, Jr., The Hidden Tyranny, <http://www.fourwinds10.com/corner/J224-ch4.pdf>, http://www.antichristconspiracy.com/HTML%20Pages/Harold_Wallace_Rosenthal_Interview_1976.htm (web address current as of April 21, 2002).

563.Des Griffin, The Fourth Reich of the Rich, p. 70 (1993), citing Le Femme et l'enfant dans la France-Maconnerie Universelle, by A.C. De La Rive, P. 588, and Occult Theocracy, pp. 220-21..

564.ALBERT PIKE, MORALS AND DOGMA OF THE ANCIENT AND ACCEPTED SCOTTISH RITE OF FREEMASONRY, p. 741 (1871).

565.RABBI DAVID A. COOPER, GOD IS A VERB, KABBALAH AND THE PRACTICE OF MYSTICAL JUDAISM, at 156 (1997) (emphasis added).

566.*Id.* at 160 (emphasis added).

567.Henry Makow, Illuminati 2, Deceit and Seduction, at 13 (2010).

568.Henry Makow, Illuminati 2, Deceit and Seduction, at 207 (2010).

569. See John S. Torell, Showdown in Jerusalem, The Dove, winter 1995.

570. MICHAEL A. HOFFMAN, JUDAISM'S STRANGE GODS, at p. 92, (2000).

571. Henry Makow, Illuminati, the Cult that Hijacked the World (2011),
http://antimatrix.org/Convert/Books/Henry_Makow/Henry_Makow_Illuminati_The_Cult_that_Hijacked_the_World.html.

572. Henry Makow, Illuminati: The Cult That Hijacked the World, at 59 (2011).

573. Henry Makow, Illuminati: The Cult That Hijacked the World, at 59 (2011).

574. Texe Marrs, The Holy Serpent of the Jews,
http://www.texemarrs.com/092012/holy_serpent_of_jews.htm (last visited on September 18, 2012).

575. Texe Marrs, The Holy Serpent of the Jews,
http://www.texemarrs.com/092012/holy_serpent_of_jews.htm (last visited on September 18, 2012).

576. Chika Flint, Examining Judaism and the Origin of the Six Pointed Star, December 18, 2011.

577. Chika Flint, Examining Judaism and the Origin of the Six Pointed Star, December 18, 2011.

578. Protocols of the Learned Elders of Zion, Preface,
<http://www.biblebelievers.org.au/przion1.htm#PREFACE> (last visited on October 17, 2012).

579. See John S. Torell, Showdown in Jerusalem, The Dove, winter 1995.

580. Baruch Levy, Letter to Karl Marx, 'La Revue de Paris', p. 574, June 1, 1928.

<http://www4.stormfront.org/posterity/ci/tjg.html>

(current as of September 9, 2001). *See also*

DON DE GRAND PRE, BARBARIANS INSIDE THE GATES, p. 64 (2000).

581. Babylonian Talmud: *Tractate Sanhedrin, Folio*

58b, Sanhedrin Translated into English with Notes,

Glossary and Indices Chapters I - VI by Jacob

Shachter, Chapters VII - XI

by H. Freedman, B.A., Ph.D., Under the Editorship of

Rabbi Dr I. Epstein B.A., Ph.D., D. Lit. (1961),

available at

http://www.come-and-hear.com/sanhedrin/sahedrin_58.html.

582. Michael Hoffman, *Judaism Discovered*, at 196

(2008) (quoting *Zohar Hadash, Bereshit* 18d-19a).

583. Henry Makow, *Illuminati: The Cult That Hijacked the World*, at 60-61 (2011).

584. The Kibbutz, Jewish Virtual Library,

http://www.jewishvirtuallibrary.org/jsource/Society_&_Culture/kibbutz.html (last visited on September 19, 2012).

585. The Kibbutz, Jewish Virtual Library,

http://www.jewishvirtuallibrary.org/jsource/Society_&_Culture/kibbutz.html (last visited on September 19, 2012).

586. Karl Marx, Critique of the Gotha Programme,

<http://www.marxists.org/archive/marx/works/1875/got/ha/ch01.htm> (last visited on September 19, 2012).

587. Henry Makow, *Illuminati: The Cult That Hijacked the World*, at 60-61 (2011).

588. Henry Makow, *Illuminati: The Cult That Hijacked the World*, at 60-61 (2011).

589. Harmony Daws, *Why Evangelicals Want to be Jews and Not Christians*,
 EVANGELICALS: IN THE IMITATION OF JEWS,
 April 28, 2010,
<http://mysteryworshippers.wordpress.com/2011/05/04/why-evangelicals-want-to-be-jews-and-not-christians/>.

590. Edith Starr Miller, *Occult Theocracy*, pp. 77 (1933) (quoting Flavien Brenier. Source: Lt. Gen. A. Netchvolodow, *Nicolas II et les Juifs*, p. 139.).

591. Edith Starr Miller, *Occult Theocracy*, pp. 78-79 (1933) (quoting Flavien Brenier. Source: Lt. Gen. A. Netchvolodow, *Nicolas II et les Juifs*, p. 139.).

592. Edith Starr Miller, *Occult Theocracy*, p. 80 (1933).

593. Edith Starr Miller, *Occult Theocracy*, p. 81 (1933).

594. *Babylonian Talmud: Tractate Sanhedrin, Folio 58b*, *Sanhedrin Translated into English with Notes, Glossary and Indices Chapters I - VI* by Jacob Shachter, Chapters VII - XI by H. Freedman, B.A., Ph.D., Under the Editorship of Rabbi Dr I. Epstein B.A., Ph.D., D. Lit. (1961), *available at*
http://www.come-and-hear.com/sanhedrin/sahedrin_58.html.

595. *Sanhedrin, Folio 58b*.

596. Babylonian Talmud: *Tractate Yebamoth, Folio 98a*, Yebamoth Translated into English with Notes Glossary and Indices by Rev. Dr. Israel W. Slotki, M.A., Litt.D., Under the Editorship of Rabbi Dr I. Epstein B.A., Ph.D., D. Lit. (1961), *available at* http://www.come-and-hear.com/yebamoth/yebamoth_98.html .

597. The Curse Against Christians at Jamnia About 90 AD, <http://www.defendingthebride.com/bb/curse.html#end> (last visited on August 20, 2012).

598. The Curse Against Christians at Jamnia About 90 AD, <http://www.defendingthebride.com/bb/curse.html#end> (last visited on August 20, 2012).

599. Ariel Toaff, *Blood Passover, The Jews of Europe and Ritual Murder*, translated into English by Gian Marco Lucchese and Pietro Gianetti, 24 August 2007, English version available in HTML at <http://www.bloodpassover.com/>, English version available in PDF at <http://www.israelshamir.net/BLOODPASSOVER.pdf>, original Italian version available in PDF at <http://www.laboratorio99.com/upload/Pasque%20di%20Sangue.pdf>.

600. Bar Ilan University, Ramat-Gan, 52900 Israel, *at* <http://www1.biu.ac.il/indexE.php> (last visited on April 7, 2010).

601. Adi Schwartz, *The Wayward Son*, Haaretz, February 22, 2007, cited by Michael Hoffman in *Judaism Discovered*, at 581 (2008).

602. Ariel Toaff, *Blood Passover*, at 10-11.

603. Ariel Toaff, *Blood Passover*, at 167.

604. Ariel Toaff, *Blood Passover*, at 167.

605. Ariel Toaff, *Blood Passover*, at 170.

606. Isabella of Spain, Chapter 25, The Trial of Benito Garcia— Expulsion of the Jews— Ritual Murder,
http://www.jrbooksonline.com/PDF_Books/QueenIsabella.pdf.

607. Ariel Toaff, *Blood Passover*, at 181,
<http://www.israelshamir.net/BLOODPASSOVER.pdf>.

608. Ariel Toaff, *Blood Passover*, at 182-83.

609. Ariel Toaff, *Blood Passover*, at 186.

610. Ariel Toaff, *Blood Passover*, at 187.

611. Talmud Unmasked , Appendix II,
<http://www.jrbooksonline.com/Talmud%20Unmasked/APPENDIX%20II.htm> (last visited on January 12, 2016).

612. Talmud Unmasked , Appendix II,
<http://www.jrbooksonline.com/Talmud%20Unmasked/APPENDIX%20II.htm> (last visited on January 12, 2016).

613. Royal Edict of the King and Queen of Spain, The Alhambra Decree, 31 March 1492,
http://www.jrbooksonline.com/PDF_Books/QueenIsabella.pdf.

614. Matt Hale, Jewish Occult Murders How and Why Jews Have Sacrificed Non-Jewish Children as Part of Their Religion, 2002,
http://antimatrix.org/Convert/Books/Matt_Hale/Jewish_Occult_Murders/Jewish_Occult_Murder.html.

615. Matt Hale, Jewish Occult Murders How and Why Jews Have Sacrificed Non-Jewish Children as Part of Their Religion, 2002,
http://antimatrix.org/Convert/Books/Matt_Hale/Jewish_Occult_Murders/Jewish_Occult_Murder.html.

616. Matt Hale, Jewish Occult Murders How and Why Jews Have Sacrificed Non-Jewish Children as Part of Their Religion, 2002,
http://antimatrix.org/Convert/Books/Matt_Hale/Jewish_Occult_Murders/Jewish_Occult_Murder.html.

617. Matt Hale, Jewish Occult Murders How and Why Jews Have Sacrificed Non-Jewish Children as Part of Their Religion, 2002,
http://antimatrix.org/Convert/Books/Matt_Hale/Jewish_Occult_Murders/Jewish_Occult_Murder.html.

618. Matt Hale, Jewish Occult Murders How and Why Jews Have Sacrificed Non-Jewish Children as Part of Their Religion, 2002,
http://antimatrix.org/Convert/Books/Matt_Hale/Jewish_Occult_Murders/Jewish_Occult_Murder.html.

619. Matt Hale, Jewish Occult Murders How and Why Jews Have Sacrificed Non-Jewish Children as Part of Their Religion, 2002,
http://antimatrix.org/Convert/Books/Matt_Hale/Jewish_Occult_Murders/Jewish_Occult_Murder.html.

620. Matt Hale, *Jewish Occult Murders How and Why Jews Have Sacrificed Non-Jewish Children as Part of Their Religion*, 2002,
http://antimatrix.org/Convert/Books/Matt_Hale/Jewish_Occult_Murders/Jewish_Occult_Murder.html.

621. *The Murder of Andrei Yushchinsky, 1917*, JR Rare Books and Commentary,
<http://www.jrbooksonline.com/leese.htm>. (last visited on January 12, 2016).

622. *The Murder of Andrei Yushchinsky, 1917*, JR Rare Books and Commentary,
<http://www.jrbooksonline.com/leese.htm>. (last visited on January 12, 2016).

623. *New York Herald*, April 6, 1850, Matt Hale, *Jewish Occult Murders How and Why Jews Have Sacrificed Non-Jewish Children as Part of Their Religion*, 2002,
http://antimatrix.org/Convert/Books/Matt_Hale/Jewish_Occult_Murders/Jewish_Occult_Murder.html.

624. *Jewish Ritual-Murder, A Historical Investigation*, at 311 (1943), English translation 2007.

625. Matt Hale, *Jewish Occult Murders How and Why Jews Have Sacrificed Non-Jewish Children as Part of Their Religion*, 2002,
http://antimatrix.org/Convert/Books/Matt_Hale/Jewish_Occult_Murders/Jewish_Occult_Murder.html.

626. Matt Hale, *Jewish Occult Murders How and Why Jews Have Sacrificed Non-Jewish Children as Part of Their Religion*, 2002,
http://antimatrix.org/Convert/Books/Matt_Hale/Jewish_Occult_Murders/Jewish_Occult_Murder.html.

627.Human Sacrifice Discussed on Oprah, October 7, 2011,
<https://www.youtube.com/watch?v=ImoZv1rprc0>.

628.Human Sacrifice Discussed on Oprah, October 7, 2011,
<https://www.youtube.com/watch?v=ImoZv1rprc0>.

629.Kitty Kelley, Oprah, at 201 (2010),
http://www.lukeford.net/profiles/profiles/vicki_polin.htm
 (last visited on January 13, 2016).

630.Kitty Kelley, Oprah, at 201 (2010),
http://www.lukeford.net/profiles/profiles/vicki_polin.htm
 (last visited on January 13, 2016).

631.Kitty Kelley, Oprah, at 201 (2010),
http://www.lukeford.net/profiles/profiles/vicki_polin.htm
 (last visited on January 13, 2016).

632.Kitty Kelley, Oprah, at 201 (2010),
http://www.lukeford.net/profiles/profiles/vicki_polin.htm
 (last visited on January 13, 2016).

633.Michael A. Hoffman II, *Judaism's Strange God's*, at 364 (2000) (quoting *Romemut Yisrael Ufarashat Hagalut*).

634.Michael A. Hoffman II, *Judaism's Strange God's*, at 364 (2000) (quoting *Romemut Yisrael Ufarashat Hagalut*).

635.Michael Hoffman, *Judaism Discovered*, at 529 (2008) (quoting Roman A. Foxbrunner, *Habad: The Hasidism of Shneur of Lyady*, at 108-09 (1993) (quoting Rabbi Shneur Zalman)).

636. Babylonian Talmud: Tractate ‘Abodah Zaran,
Folio 17a.

637. Babylonian Talmud: Tractate Sanhedrin Folio
106a.

638. Babylonian Talmud: Tractate Gittin Folio 57a.

639. Michael Hoffman, *Judaism Discovered*, at 357
(2008).

640. Chagigah 27a (a/k/a Hagigah 27a), *A Translation
of the Treatise Chagigah from the Babylonian Talmud*,
With Introduction, Notes, Glossary, and Indices by the
Rev. A. W. Strean, M.A. Fellow, and Divinity and
Hebrew Lecturer, of Corpus Christi College,
Cambridge, and Formerly Tyrwhitt’s Hebrew Scholar,
at 145 (1891), available at
[http://www.archive.org/details/chagigahbabyloni00unk
nuoft](http://www.archive.org/details/chagigahbabyloni00unknuoft).

641. Tractate Baba Bathra Folio 75a at footnote 15.

642. Michael Hoffman, *Judaism Discovered*, at 196
(2008) (quoting *Zohar Hadash, Bereshit* 18d-19a).

643. Michael Hoffman, *Judaism Discovered*, at 196
(2008).

644. Michael Hoffman, *Judaism Discovered*, at 203
(2008).

645. William Wotton, *Miscellaneous Discourses
Relating to the Traditions and Usages of the Scribes
and Pharisees in Our Blessed Saviour Jesus Christ’s
Time* (London 1718) (quoted by Michael Hoffman,
Judaism Discovered, at 193 (2008)).

646. Michael Hoffman, *Judaism Discovered*, at 172 n.156 (2008).

647. Babylonian Talmud,
http://come-and-hear.com/sanhedrin/sanhedrin_57.html#57a_33.

648. Babylonian Talmud,
http://come-and-hear.com/sanhedrin/sanhedrin_57.html#57a_33.

649. Michael Hoffman, *Judaism Discovered*, at 660 (2008).

650. Michael Hoffman, *Judaism Discovered*, at 660 (2008).

651. Michael Hoffman, *Judaism Discovered*, at 660 (2008).

652. Michael Hoffman, *Judaism Discovered*, at 664 (2008) (quoting Israel Shahak, *Jewish History, Jewish Religion*, pp. 22-23).

653. Michael Hoffman, *Judaism Discovered*, at 663 (2008).

654. Jewish Encyclopedia, *Balaam*, available at <http://www.jewishencyclopedia.com/view.jsp?artid=161&letter=B> (last visited on March 10, 2010).

655. Babylonian Talmud: *Tractate Sanhedrin, Folio 106b*, Sanhedrin Translated into English with Notes, Glossary and Indices Chapters I - VI by Jacob Shachter, Chapters VII - XI by H. Freedman, B.A., Ph.D., Under the Editorship of Rabbi Dr I. Epstein B.A., Ph.D., D. Lit. (1961), available at

http://www.come-and-hear.com/sanhedrin/sanhedrin_106.html.

656. Babylonian Talmud: *Tractate Sanhedrin, Folio 106b, at n.6*, Sanhedrin Translated into English with Notes, Glossary and Indices Chapters I - VI by Jacob Shachter, Chapters VII - XI by H. Freedman, B.A., Ph.D., Under the Editorship of Rabbi Dr I. Epstein B.A., Ph.D., D. Lit. (1961), *available at*

http://www.come-and-hear.com/sanhedrin/sanhedrin_106.html.

657. Elizabeth Dilling, *The Jewish Religion, Its Influence Today* (1963), *at*

<http://www.come-and-hear.com/dilling/chapt03.html#T159>.

658. The scholars listed as contributing to the Jewish Encyclopedia entry for *Balaam* are: Morris Jastrow, Jr., Ph.D., Professor of Semitic Languages, University of Pennsylvania; Ira Maurice Price, Ph.D., LL.D., Professor of Semitic Languages and Literature, University of Chicago; Marcus Jastrow, Ph.D., Rabbi Emeritus of the Congregation Rodef Shalom, Philadelphia; H. M. Speaker, Gratz College; John Dyneley Prince, Ph.D., Professor of Semitic Languages, New York University; Dr. S. Mühsam, Chief Rabbi of Gratz, Austria; Kaufmann Kohler, Ph.D., Rabbi Emeritus of Temple Beth-El, New York, President of the Hebrew Union College.

659. Jewish Encyclopedia, *Jesus of Nazareth*, *available at*

<http://www.jewishencyclopedia.com/view.jsp?artid=254&letter=J&search=jesus> (last visited on March 10, 2010).

660. Edith Starr Miller, *Occult Theocracy*, p. 86 (1933).

661. Edith Starr Miller, *Occult Theocracy*, p. 87 (1933).

662. Babylonian Talmud,
http://come-and-hear.com/sanhedrin/sanhedrin_52.htm
 1. See also English Babylonian Talmud,
<http://halakhah.com> (last visited on December 2,
 2015).

663. Talmud, *Tractate Sanhedrin, Folio 100b*, n.6
 (1961), *available at*
http://www.come-and-hear.com/sanhedrin/sanhedrin_100.html (emphasis added).

664. Judaism vs. Christianity: The War The Lamb Wins, <http://www.fixedearth.com/talmud.html> (current as of September 11, 2001).

665. DONN DE GRAND PRE, BARBARIANS INSIDE THE GATES, THE BLACK BOOK OF BOLSHEVISM, p. 209 (2000) (quoting BEJAMIN FREEDMAN, *FACTS ARE FACTS* (1954)).

666. Babylonian Talmud: *Tractate Sanhedrin, Folio 106a*, Sanhedrin Translated into English with Notes, Glossary and Indices Chapters I - VI by Jacob Shachter, Chapters VII - XI by H. Freedman, B.A., Ph.D., Under the Editorship of Rabbi Dr I. Epstein B.A., Ph.D., D. Lit. (1961), *available at*
http://www.come-and-hear.com/sanhedrin/sanhedrin_106.html.

667. Babylonian Talmud: *Tractate Sanhedrin, Folio 106a*, at n.42, Sanhedrin Translated into English with Notes, Glossary and Indices Chapters I - VI by Jacob

Shachter, Chapters VII - XI

by H. Freedman, B.A., Ph.D., Under the Editorship of Rabbi Dr I. Epstein B.A., Ph.D., D. Lit. (1961), *available at*

http://www.come-and-hear.com/sanhedrin/sanhedrin_106.html.

668. Babylonian Talmud: *Tractate Gittin, Folio 57a*, Gittin Translated into English with Notes, Glossary and Indices By Maurice Simon, M.A. Under the Editorship of Rabbi Dr. I. Epstein B.A., Ph.D., D. Lit. (1961), *available at*

http://www.come-and-hear.com/gittin/gittin_57.html.

669. Jewish Encyclopedia, *Balaam*, *available at*

<http://www.jewishencyclopedia.com/view.jsp?artid=161&letter=B> (last visited on March 10, 2010).

670. Babylonian Talmud: *Tractate Gittin, Folio 57a*, at n.3, Gittin Translated into English with Notes, Glossary and Indices By Maurice Simon, M.A. Under the Editorship of Rabbi Dr. I. Epstein B.A., Ph.D., D. Lit. (1961), *available at*

http://www.come-and-hear.com/gittin/gittin_57.html.

671. Soncino Press, <http://www.soncino.com/about> (last visited on December 2, 2015).

672. Michael Hoffman, *Judaism Discovered*, at 785 (2008).

673. Lawrence Fine, Chapter on Kabbalistic Texts, From: *Back to the Sources: Reading the Classic Jewish Texts* (“The First Complete Modern Guide to the Great Books of the Jewish Tradition: What They Are and How to Read Them”), at p. 337 (2006) (bold emphasis added, italics in original).

674.Lawrence Fine, Chapter on Kabbalistic Texts,
From: *Back to the Sources: Reading the Classic Jewish
Texts* (“The First Complete Modern Guide to the Great
Books of the Jewish Tradition: What They Are and
How to Read Them”), at p. 337 (2006) (quoting Zohar
III, 152a).

675.Blavatsky, Theosophical Glossary, p. 168 (quoted
by Barbara Aho, *Mystery, Babylon the Great Catholic
or Jewish?*, at
<http://watch.pair.com/mystery-babylon.html#cabala>
(last visited on April 17, 2010)).

676.MICHAEL A. HOFFMAN, JUDAISM’S
STRANGE GODS, at p. 88, (2000).

677.MICHAEL A. HOFFMAN, JUDAISM’S
STRANGE GODS, at p. 88, (2000). See also Michael
Hoffman, *Judaism Discovered*, at 779 (2008) (quoting
Gershom Scholem, *Kabbalah* pp.183-84).

678.MICHAEL A. HOFFMAN, JUDAISM’S
STRANGE GODS, at p. 91, (2000).

679.Michael Hoffman, *Judaism Discovered*, at 780
(2008) (quoting Helen Jacaobus, *Eye Jinx*, *Jewish
Chronicle*, May 7, 1999).

680.Protocols of the Learned Elders of Zion, Protocol
16,
[http://www.biblebelievers.org.au/przion5.htm#protocol
%20No.%2016](http://www.biblebelievers.org.au/przion5.htm#protocol%20No.%2016) (last visited on October 9, 2012).

681.Protocols of the Learned Elders of Zion, Protocol
4,
[http://www.biblebelievers.org.au/przion3.htm#PROTO
COL%20No.%204](http://www.biblebelievers.org.au/przion3.htm#PROTOCOL%20No.%204) (Last visited on August 23, 2012).

682. George Orwell, 1984, at chapter 3,
<https://ebooks.adelaide.edu.au/o/orwell/george/o79n/chapter3.3.html>.

683. George Orwell, 1984, at part 3, chapter 3,
<https://ebooks.adelaide.edu.au/o/orwell/george/o79n/chapter3.3.html>.

684. George Orwell, 1984, at part 3, chapter 3,
<https://ebooks.adelaide.edu.au/o/orwell/george/o79n/chapter3.3.html>.

685. George Orwell, 1984, at part 1, chapter 3.

686. George Orwell, 1984, at part 2, chapter 9.

687. Eric Dubay Interview,
<http://www.atlanteanconspiracy.com/2015/04/eric-dubay-flat-earth-interviews.html> (last visited on September 9, 2015).

688. Eric Dubay Interview,
<http://www.atlanteanconspiracy.com/2015/04/eric-dubay-flat-earth-interviews.html> (last visited on September 9, 2015).

689. Francis X. Clines, Reagan's Doubts on Dr. King Disclosed, *The New York Times*, October 23, 1983,
<http://www.nytimes.com/1983/10/22/us/reagan-s-doubt-s-on-dr-king-disclosed.html>.

690. Marcus Epstein, Myths of Martin Luther King, January 18, 2003,
<https://www.lewrockwell.com/2003/01/marcus-epstein/myths-of-martin-luther-king/>.

691. Jimmy T. (Gunny) LaBaume, When Judged by the Content of His Character, January 18, 2016 (citing

Starrett, Mary, How a Marxist Came to be an American Hero, NewsWithViews.com January 16, 2004. Quoted within that article: King, A Critical Biography by David Lewis, Martin Luther King, The Man Behind The Myth, by Des Griffin and the National Observer, 1963.)

692.Labaume, supra.

693.Jimmy T. (Gunny) LaBaume, When Judged by the Content of His Character, January 18, 2016 (citing Steele, Edgar J., The Perfect American Holiday; Horne, Cadrmeron L., HAPPY BIRTHDAY, ROBERT E. LEE or Happy Birthday, Martin Luther King, Jr.?.; Hoffman, Michael, 1992, Holiday for a Cheater, Wiswell Ruffin House, Dresden, New York; Montgomery, Victor M. Letter to the Editor. Greenville, NC newspaper of record.

694.Don Boys, Was MLK a Communist?, January 19, 2009,
<http://www.conservativetruth.org/article.php?id=928>.

695.Don Boys, Was MLK a Communist?, January 19, 2009,
<http://www.conservativetruth.org/article.php?id=928>.

696.Don Boys, Was MLK a Communist?, January 19, 2009,
<http://www.conservativetruth.org/article.php?id=928>.

697.Don Boys, Was MLK a Communist?, January 19, 2009,
<http://www.conservativetruth.org/article.php?id=928>.

698.Don Boys, Was MLK a Communist?, January 19, 2009,

<http://www.conservativetruth.org/article.php?id=728>.

699. Did You Say Dr. Martin Luther King Jr. Was a Phony?,

http://frontline.org.za/index.php?option=com_content&id=1506:did-you-say-dr-martin-luther-king-jr-was-a-phony#sthash.9nFC0e2O.dpuf (last visited on May 15, 2016).

700. Did You Say Dr. Martin Luther King Jr. Was a Phony?,

http://frontline.org.za/index.php?option=com_content&id=1506:did-you-say-dr-martin-luther-king-jr-was-a-phony#sthash.9nFC0e2O.dpuf (last visited on May 15, 2016).

701. Don Boys, Was MLK a Communist?, January 19, 2009,

<http://www.conservativetruth.org/article.php?id=928>.

702. Kevin Alfred Strom, The Beast as Saint: The Truth About Martin Luther King, Jr.,

http://www.jesus-is-savior.com/Wolves/king_jr-exposed.htm (last visited on May 21, 2016).

703. Kevin Alfred Strom, The Beast as Saint: The Truth About Martin Luther King, Jr.,

http://www.jesus-is-savior.com/Wolves/king_jr-exposed.htm (last visited on May 21, 2016).

704. Todd Starnes, Christian Bakers Fined \$135,000 for Refusing to Make Wedding Cake for Lesbians, Fox News, July 3, 2015,

<http://www.foxnews.com/opinion/2015/07/03/christian-bakers-fined-135000-for-refusing-to-make-wedding-cake-for-lesbians.html>.

705.Todd Starnes, *supra*.

706.Did CIA Director William Casey Really Say ‘We’ll Know Our Disinformation Program Is Complete When Everything the American Public Believes Is False’?, *Infinite Unknown*, <http://www.infiniteunknown.net> (last visited on March 17, 2016).

707.Did William Casey (CIA Director) really say, "We'll know our disinformation program is complete when everything the American public believes is false."?, <https://www.quora.com/Did-William-Casey-CIA-Director-really-say-Well-know-our-disinformation-program-is-complete-when-everything-the-American-public-believes-is-false> (last visited on April 28, 2016).

708.MOCKINGBIRD: The Subversion Of The Free Press By The CIA, www.whatreallyhappened.com (last visited on April 24, 2016).

709.MOCKINGBIRD: The Subversion Of The Free Press By The CIA, www.whatreallyhappened.com, citing Katherine The Great, by Deborah Davis (New York: Sheridan Square Press, 1991).

710.Michael Collins Piper, *Final Judgement*, 6th Edition, at 260 (2007).

711.David Wise, *The American Police State: The Government Against the People*. (New York: Random House, 1976), pp. 200-201, quoted in Michael Collins Piper, *Final Judgement*, 6th Edition, at 260 (2007).

712.David Wise, *supra*, at 200-201.

713. Alex Constantine, *The Depraved Spies and Moguls of the CIA's Operation MOCKINGBIRD*, www.whatreallyhappened.com (last visited on April 24, 2016), citing Deborah Davis, *Katharine The Great*, New York: Sheridan Square Press, at 119-132, 1991, and Carl Bernstein, *The CIA and the Media*, October 20, 1977.

714. Carl Bernstein, *The CIA and the Media*, October 20, 1977, http://www.carlbernstein.com/magazine_cia_and_media.php.

715. Carl Bernstein, *supra*.

716. Carl Bernstein, *supra*.

717. Carl Bernstein, *supra*.

718. *MOCKINGBIRD: The Subversion Of The Free Press By The CIA*, www.whatreallyhappened.com (last visited on April 24, 2016).

719. Edward Bernays, *Propaganda*, at 37 (1928).

720. Bernays at 38.

721. CONG. REC. 2947-2948 (February 9, 1917) (speech of Rep. Callaway), <http://www.iahf.com/media.html> (current as of October 3, 2001).

722. Granville Williams, *Bestriding The World, Campaign for Press and Broadcasting Freedom*, New Internationalist magazine, <http://www.mediachannel.org/ownership/granville.shtml> (last visited on May 25, 2008). Christopher Bollyn, *Arnon Milchan & Israeli Control of the Media*, <http://www.bollyn.com/index/?id=10568> (September

1, 2007).

723. CONG. REC. 2947-2948 (February 9, 1917) (speech of Rep. Callaway), <http://www.iahf.com/media.html> (current as of October 3, 2001).

724. ERIC JON PHELPS, VATICAN ASSASSINS: "WOUNDED IN THE HOUSE OF MY FRIENDS," p. 465 (2001) (quoting A U.S. Police Action: Operation Vampire Killer, pp. 18-19 (1992)).

725. Building 7, the Secrecy Shrouded Building Holding Guiliani's Command Center, <http://911research.wtc7.net/wtc/background/wtc7.html> (web address current as of October 24, 2004).

726. Rudolph Guiliani Interview, The Hall of Public Service, <http://www.achievement.org/autodoc/page/giu0int-7> (web address current as of October 24, 2004).

727. BBC Reported Building 7 Collapse 20 Minutes Before It Fell, <http://www.youtube.com/watch?v=C7SwOT29gbc&mode=related&search=> (last visited on June 2, 2008).

728. Richard Porter, *Part of the conspiracy?*, BBC, February 27, 2007, http://www.bbc.co.uk/blogs/theeditors/2007/02/part_of_the_conspiracy.html.

729. Richard Porter, *Part of the conspiracy?*, BBC, February 27, 2007, http://www.bbc.co.uk/blogs/theeditors/2007/02/part_of_the_conspiracy.html.

730. BBC Anchor Agrees WTC-7 Collapse May Be a Conspiracy, May 2, 2008,

<http://noworldsystem.com/category/jane-standle/>.

731. Richard Porter, *Part of the conspiracy?*, BBC, February 27, 2007,
http://www.bbc.co.uk/blogs/theeditors/2007/02/part_of_the_conspiracy.html.

732. Statement of Principles, New American Century, January 3, 1997,
<http://www.newamericancentury.org/statementofprinciples.htm>.

733. Rebuilding America's Defenses, Strategy, Forces and Resources for a New Century, A Report of The Project for a New American Century, at 51, September 2000,
<http://www.newamericancentury.org/RebuildingAmericasDefenses.pdf>.

734. Marshall Hall, Kabbala, Part VII, The Concept of a Rotating Earth Orbiting the Sun Is Both the Pseudo-Scientific Foundation and The Achilles Heel of Modern Kabbala-based Cosmology,
<http://www.fixedearth.com/kabbala-7.html> (last visited on September 17, 2015).

735. The Secret Wisdom of Qabalah", by J.F.C. Fuller,
<http://216.109.125.130/search/cache?ei=UTF-8&p=Aristarchus+Copernicus+Kabbalism&fr...> p. 19 of 56.

736. Marshall Hall, Sola Scriptura - IV: Kabbala Phariseism or Bible Christianity?,
<http://www.fixedearth.com/sola-scriptura-4.html> (last visited on September 18, 2015).

737. Chazal's View of the World, Torat Emet,
http://www.aishdas.org/toratemet/en_shape.html (last

visited on September 17, 2015).

738. What the Sages Knew About the Shape of the Earth,

http://www.daatemet.org/articles/article.cfm?article_id=16 (last visited on September 18, 2015).

739. Talmud, Tractate Abodah Zarah at Folio 41a,

http://www.come-and-hear.com/zarah/zarah_41.html (last visited on September 17, 2015).

740. Jerusalem Tractate Abodah Zarah, Chapter 3,

<http://www.jewishvirtuallibrary.org/jsourc/Talmud/avodazara3.html> (last visited on September 17, 2015).

741. Chazal's View of the World, Torat Emet,

http://www.aishdas.org/toratemet/en_shape.html (last visited on September 17, 2015). See also, Ronald H. Isaacs, *Divination, Magic, and Healing: The Book of Jewish Folklore*, at 33, 1998.

742. Chazal's View of the World, Torat Emet,

http://www.aishdas.org/toratemet/en_shape.html (last visited on September 17, 2015).

743. George William Rutler, Nicolaus Copernicus,

Catholic Education Resource Center,

<http://www.catholiceducation.org/en/science/faith-and-science/nicolaus-copernicus.html> (last visited on September 17, 2015).

744. Michael Hoffman, *The Truth About the Talmud*, at

<http://www.revisionisthistory.org/talmudtruth.html>

(last visited on March 10, 2010) (excerpted from MICHAEL A. HOFFMAN, *JUDAISM'S STRANGE GODS* (2000)).

745. Robert Goldberg, *Talmud, Back to the Sources. Reading the Classic Jewish Texts* (New York: Simon and Schuster, 1984), p. 130 (quoted by Michael Hoffman, *Judaism Discovered*, at 187 (2008)).

746. Michael Hoffman, *Judaism Discovered*, at 189 (2008).

747. Rabbi Ben Zion Bokser, *Judaism and the Christian Predicament* (1966), pp. 59 and 159 (quoted by Michael Hoffman, *Judaism Discovered*, at 190 (2008)).

748. Michael Hoffman, *The Truth About the Talmud*, at <http://www.revisionisthistory.org/talmudtruth.html> (excerpted from MICHAEL A. HOFFMAN, JUDAISM'S STRANGE GODS (2000)).

749. Michael Hoffman, *The Truth About the Talmud*, at <http://www.revisionisthistory.org/talmudtruth.html> (excerpted from MICHAEL A. HOFFMAN, JUDAISM'S STRANGE GODS (2000)) (quoting Ari Goldman, New York Times, April 10, 1993, p. 38).

750. Michael Hoffman, *The Truth About the Talmud*, at <http://www.revisionisthistory.org/talmudtruth.html> (excerpted from MICHAEL A. HOFFMAN, JUDAISM'S STRANGE GODS (2000)).

751. Michael Hoffman, *The Truth About the Talmud*, at <http://www.revisionisthistory.org/talmudtruth.html> (excerpted from MICHAEL A. HOFFMAN, JUDAISM'S STRANGE GODS (2000)).

752. Jewish Encyclopedia, Cabala, at <http://www.jewishencyclopedia.com/view.jsp?artid=1&letter=C#4> (last visited on April 18, 2010).

753. Marshall Hall, Kabbala, Part III, Judaism...
Theological Anarchy or Kabbalists in Control All
Along?, <http://www.fixedearth.com/kabbala-3.html>.

754. Marshall Hall, Kabbala, Part IV, Some Insights to
Ponder and Evaluate About the Hidden, Secretive
Makeup of Kabbalism,
<http://www.fixedearth.com/kabbala-4.html>, quoting
Mail. Jewish Mailing List, vol. 20, #6, p. 5 of 6;
<http://www.shamash.org>.

755. Tracey R Rich, Judaism 101, Sages and Scholars,
<http://www.jewfaq.org/sages.htm> (last visited on
September 11, 2015).

756. Nachmanides,
<http://www.creatia.org/timeline/nachmanides.htm> (last
visited on September 11, 2015).

757. Yakov Leib haKohain,
<http://www.kheper.net/topics/Kabbalah/Yakov.htm>
(last visited on September 12, 2015).

758. Yakov Leib HaKohain, Short essay on Lurianic
Kabbalah,
<http://www.kheper.net/topics/Kabbalah/LurianicKabbalah.htm> (last visited on September 12, 2015).

759. Gerald Schroeder, The Age of the Universe,
<http://www.geraldschroeder.com/AgeUniverse.aspx>
(last visited on September 12, 2015).

760. Schroeder, *supra*.

761. Marshall Hall, Kabbala, Part III, Judaism:
Theological Anarchy, Or Kabbalists in Control All
Along?, <http://www.fixedearth.com/kabbala-3.html>
(last visited on September 12, 2015).

762. Edgar B. Herwick III, *Big Bang Theory: A Roman Catholic Creation*, March 20, 2014,
<http://wgbhnews.org/post/big-bang-theory-roman-catholic-creation>.

763. Mark Midbon, 'A Day Without Yesterday': Georges Lemaitre & the Big Bang, *Commonweal Magazine* Vol. 127 No. 6 (March 24, 2000) 18-19, republished by the Catholic Education Resource Center,
<http://www.catholiceducation.org/en/science/faith-and-science/a-day-without-yesterday-georges-lemaitre-amp-the-big-bang.html>.

764. *Israel Modern History: Offering the Presidency of Israel to Albert Einstein* (November 17, 1952),
<https://www.jewishvirtuallibrary.org/jsource/Politics/einsteinlet.html>.

765. *Anti-Zion, Jews on the Jewish Question*,
<http://www.diac.com/~bkennedy/az/A-E.html> (current as of September 10, 2001).

766. Edith Starr Miller (Lady Queenborough), *Occult Theocracy*, p. 319 (1933).

767. Ivan Fraser, *Protocols of the Learned Elders of Zion, Proofs of an Ancient Conspiracy*,
http://www.vegan.swinternet.co.uk/articles/conspiracies/protocols_proof.html (current as of September 10, 2001).

768. Barbara Aho, *Mystery, Babylon the Great - Catholic or Jewish?, Part III, The Jesuits, Watch Unto Prayer*, at <http://watch.pair.com/mystery-babylon.html> (last visited on February 8, 2010).

769.The Abbate Leone, *The Jesuit Conspiracy, The Secret Plan of the Order*, at 183-84 (1848).

770.John S. Torell, *European-American Evangelical Association*, July 1999,
<http://www.eaec.org/NL99jul.htm> (current as of October 2, 2001).

771.John S. Torell, *European-American Evangelical Association*, July 1999,
<http://www.eaec.org/NL99jul.htm> (current as of October 2, 2001).

772.John S. Torell, *European-American Evangelical Association*, July 1999,
<http://www.eaec.org/NL99jul.htm> (current as of October 2, 2001).

773.MANFRED BARTHEL, *THE JESUITS, HISTORY AND LEGEND OF THE SOCIETY OF JESUS*, p. 16 (1984).

774.COLLIER'S ENCYCLOPEDIA, vol. 13, p. 550 (1992).

775.Melinda Henneberger, *Vatican Says Jews' Wait for Messiah Is Validated by the Old Testament*, *New York Times*, January 18, 2002,
http://www.hughhewitt.com/past_news_links_01.02/01.18.02.Vatican_Says_Wait_for_Messiah.html (Current as of February 10, 2002).

776.Michael Hoffman II, *Secret Societies and Psychological Warfare*, at p. 75 (2001).

777.Michael Hoffman II, *Secret Societies and Psychological Warfare*, at p. 75 (2001).

778. Vatican Tells Catholics Not to Attempt to Convert Jews, *The Guardian*, December 10, 2015,
<http://www.theguardian.com/world/2015/dec/10/vatican-tells-catholics-not-to-attempt-to-convert-jews>.

779. Edward Hendrie, *The Anti-Gospel, The Perversion of Christ's Grace Gospel*, available at www.antichristconspiracy.com and www.lulu.com.

780. G. Richard Fisher, *The Other Gospel Of John Hagee: Christian Zionism And Ethnic Salvation, Personal Freedom Outreach*,
<http://www.pfo.org/jonhagee.htm> (last visited on May 15, 2012).

781. Steven Paas, *Christian Zionism Examined, A Review of Ideas on Israel , the Church, and the Kingdom*, at 28 (2012).

782. Steven Paas, *Christian Zionism Examined, A Review of Ideas on Israel , the Church, and the Kingdom*, at 98 (2012).

783. Steven Paas, *Christian Zionism Examined, A Review of Ideas on Israel , the Church, and the Kingdom*, at 102 (2012).

784. *Babylonian Talmud: Tractate Sanhedrin, Folio 90a*, Sanhedrin Translated into English with Notes, Glossary and Indices Chapters I - VI by Jacob Shachter, Chapters VII - XI by H. Freedman, B.A., Ph.D., Under the Editorship of Rabbi Dr I. Epstein B.A., Ph.D., D. Lit. (1961), available at http://www.come-and-hear.com/sanhedrin/sanhedrin_90.html.

785. Babylonian Talmud: *Tractate Sanhedrin, Folios 90a*, Sanhedrin Translated into English with Notes, Glossary and Indices Chapters I - VI by Jacob Shachter, Chapters VII - XI by H. Freedman, B.A., Ph.D., Under the Editorship of Rabbi Dr I. Epstein B.A., Ph.D., D. Lit. (1961), available at http://www.come-and-hear.com/sanhedrin/sanhedrin_90.html.

786. Michael Hoffman, *Judaism Discovered*, at 534 (2008).

787. Elizabeth Dilling, *The Jewish Religion, Its Influence Today* (1963), at http://www.come-and-hear.com/dilling/chapt03.html#The_18_Benedictions.

788. Steven Paas, *Christian Zionism Examined, A Review of Ideas on Israel, the Church, and the Kingdom*, at 105 (2012).

789. Steven Paas, *Christian Zionism Examined, A Review of Ideas on Israel, the Church, and the Kingdom*, at 113 (2012).

790. ALBERTO RIVERA, *DOUBLE CROSS*, Chick Publications, p. 12, 1981. *See also*, EDWIN A. SHERMAN, *THE ENGINEER CORPS OF HELL*, Library of Congress catalog card # 66-43354, p. 118 (1883); Congressional Record, House Bill 1523, contested election case of Eugene C. Bonniwell against Thos. S. Butler, February 15, 1913, at pp. 3215-16; BURKE MCCARTY, *THE SUPPRESSED TRUTH ABOUT THE ASSASSINATION OF ABRAHAM LINCOLN*, at pp. 14-16.

791. EDMOND PARIS, THE SECRET HISTORY OF THE JESUITS, p. 29 (1975).

792. *Id.*

793. *Id.*

794. EDMOND PARIS, THE SECRET HISTORY OF THE JESUITS, p. 26 (1975).

795. Barbara Aho, *Mystery, Babylon the Great - Catholic or Jewish?, Part III, The Jesuits, Watch Unto Prayer*, at <http://watch.pair.com/mystery-babylon.html> (last visited on February 8, 2010) (quoting Maurice Pinay, *The Plot Against the Church, Chapter Thirty-Nine, Jewish-Freemasonic Infiltration into the Jesuit Order*, <http://www.catholicvoice.co.uk/pinay/part4d.htm> (last visited February 10, 2010)).

796. THE PROTOCOLS OF THE LEARNED ELDERS OF ZION, Paragraph 3, Protocol 17, http://www.thewinds.org/library/protocols_of_zion.html (current as of September 9, 2001).

797. THE PROTOCOLS OF THE LEARNED ELDERS OF ZION, Paragraph 4, Protocol 17, http://www.thewinds.org/library/protocols_of_zion.html (current as of September 9, 2001).

798. ALBERTO RIVERA, DOUBLE CROSS, Chick Publications, p. 12, 1981. *See also*, EDWIN A. SHERMAN, THE ENGINEER CORPS OF HELL, Library of Congress catalog card # 66-43354, p. 118 (1883); Congressional Record, House Bill 1523, contested election case of Eugene C. Bonniwell against Thos. S. Butler, February 15, 1913, at pp. 3215-16;

BURKE MCCARTY, THE SUPPRESSED FROM
ABOUT THE ASSASSINATION OF ABRAHAM
LINCOLN, at pp. 14-16.

799. EDMOND PARIS, THE SECRET HISTORY OF
THE JESUITS, p. 70 (1975).

800. COLLIER'S ENCYCLOPEDIA, volume 13, p.
550 (1991); *see also*, EDMOND PARIS, THE
SECRET HISTORY OF THE JESUITS, p. 70 (1975).

801. EDMOND PARIS, THE SECRET HISTORY OF
THE JESUITS, p. 73 (1975).

802. EDMOND PARIS, THE SECRET HISTORY OF
THE JESUITS, p. 70 (1975).

803. *Id.* at 70-71.

804. *Id.* at 71.

805. COLLIER'S ENCYCLOPEDIA, volume 12, p.
516 (1991).

806. SIDNEY HUNTER, IS ALBERTO FOR REAL?,
p. 21 (1991); *see also*, EDMOND PARIS, THE
SECRET HISTORY OF THE JESUITS, p. 35 (1975).

807. SIDNEY HUNTER, IS ALBERTO FOR REAL?,
Chick Publications, p. 21-23 (1988).

808. ERIC JON PHELPS, VATICAN ASSASSINS:
"WOUNDED IN THE HOUSE OF MY FRIENDS," P.
206 (2001).

809. WILLIAM STILL, NEW WORLD ORDER, The
Ancient Plan of Secret Societies, p. 79 (1990).

810.ERIC JON PHELPS, VATICAN ASSASSINS.
“WOUNDED IN THE HOUSE OF MY FRIENDS,” p.
205 (2001).

811.ERIC JON PHELPS, VATICAN ASSASSINS:
“WOUNDED IN THE HOUSE OF MY FRIENDS,” p.
205 (2001).

812.WILLIAM STILL, NEW WORLD ORDER, The
Ancient Plan of Secret Societies, pp. 81-91 (1990).

813.COLLIER’S ENCYCLOPEDIA, volume 13, p.
550 (1991).

814.EDMOND PARIS, THE SECRET HISTORY OF
THE JESUITS, p. 75 (1975).

815.*Id.*

816.SAMUEL FINLEY BREESE MORSE,
IMMINENT DANGERS TO THE FREE
INSTITUTIONS OF THE UNITED STATES
THROUGH FOREIGN IMMIGRATION AND THE
PRESENT STATE OF THE NATURALIZATION
LAWS, p. 9-10 (1835).

817.COLLIER’S ENCYCLOPEDIA, vol. 13, p. 550
(1991).

818.*Id.*

819.*Id.* *See also*, EDMOND PARIS, THE SECRET
HISTORY OF THE JESUITS, p. 39 (1975).

820.COLLIER’S ENCYCLOPEDIA, volume 13, p.
550 (1991).

821.PARIS at p. 64.

822.PARIS at p. 65.

823.PARIS at p. 65.

824.PARIS at p. 65.

825.JOHN W. ROBBINS, ECCLESIASTICAL MEGALOMANIA, at p. 32 (1999) (quoting *Summa Theologiae*, ii-ii, 7th article).

826. JOHN W. ROBBINS, ECCLESIASTICAL MEGALOMANIA, at p. 40 (1999) (quoting The Second Vatican Council, *Gaudium et Spes, Pastoral Constitution on the Church in the Modern World*, at p. 69 (1965)).

827.Babylonian Talmud, *Tractate Baba Bathra, Folio 54b* (1961), available at http://www.come-and-hear.com/bababathra/bababathra_54.html.

828.Babylonian Talmud, *Tractate Baba Kamma, Folio 113b*, Translated into English with Notes, Glossary and Indices by E. W. Kirzner, M.A., Ph.D., M.Sc, under the Editorship of Rabbi Dr I. Epstein, B.A., Ph.D., D. Lit. (1961), available at http://www.come-and-hear.com/babakamma/babakamma_113.html.

829.J. E. C. SHEPHERD, THE BABINGTON PLOT, Wittenburg Publications, p.14, 1987.

830.EDMOND PARIS, THE SECRET HISTORY OF THE JESUITS, p. 26 (1975).

831.J. E. C. SHEPHERD, THE BABINGTON PLOT, Wittenburg Publications, p.16, 1987 (quoting Marianus de Luce, S.J., Professor Canon Law, Gregorian

University of Rome, *Institutes of Public Ecclesiastical Law*, with personal commendation from Pope Leo XIII, 1901).

832. EDMOND PARIS, *THE SECRET HISTORY OF THE JESUITS*, Chick Publications, p. 166-167, 1975.

833. *Babylonian Talmud: Tractate Sanhedrin, Folio 57b*, Sanhedrin Translated into English with Notes, Glossary and Indices Chapters I - VI by Jacob Shachter, Chapters VII - XI by H. Freedman, B.A., Ph.D., Under the Editorship of Rabbi Dr I. Epstein B.A., Ph.D., D. Lit. (1961), *available at* http://www.come-and-hear.com/sanhedrin/sanhedrin_57.html (the section actually uses the word “Cuthean,” but an endnote explains: “‘Cuthean’ (Samaritan) was here substituted by the censor for the original goy (heathen).”).

834. *Babylonian Talmud: Tractate Sanhedrin, Folio 57b*, *supra*.

835. Michael Hoffman, *Judaism Discovered*, at 441 (2008).

836. Michael Hoffman, *Judaism Discovered*, at 441 (2008).

837. *Canadian Jewish News*, p. 9, August 23, 1980, quoted by Michael Hoffman in *Judaism Discovered*, at 442 (2008).

838. Israel Shahak, *Jewish History, Jewish Religion: The Weight of Two Thousand Years* (1994) (citing Maimonides, *Mishneh Torah*, 'Laws on Murderers' 2, 11; *Talmudic Encyclopedia*, 'Goy'), *available at*

<http://www.biblebelievers.org.au/jewhis5.htm#118720Laws%20Against%20Non-Jews>.

839. Shahak, Jewish History (citing R. Yo'el Sirkis, Bayit Hadash, commentary on Beyt Josef, 'Yoreh De'ah' 158. Shahak explains in an endnote: "The two rules just mentioned apply even if the Gentile victim is ger toshav, that is a 'resident alien' who has undertaken in front of three Jewish witnesses to keep the 'seven Noahide precepts' (seven biblical laws considered by the Talmud to be addressed to Gentiles)").

840. Shahak, Jewish History (citing R. David Halevi (Poland, 17th century), Turey Zahav" on Shulhan 'Arukh, 'Yoreh De'ah' 158).

841. Shahak, Jewish History (citing Talmudic Encyclopedia, 'Ger' (= convert to Judaism)).

842. Shahak, Jewish History (citing Shulhan 'Arukh, 'Hoshen Mishpat' 426).

843. Shahak, Jewish History (Tractate 'Avodah Zarah', p. 26b).

844. Shahak, Jewish History (Maimonides, op. cit., 'Murderer' 4, 11).

845. Shahak, Jewish History (citing Leviticus, 19:16). Shahak also states in an endnote: "Concerning the rendering 'thy fellow', see note 14 to Chapter 3."

846. Shahak, Jewish History (citing Maimonides, op. cit., 'Idolatry' 10, 1-2).

847. Shahak, Jewish History (Shahak states in an endnote: "In both cases in section 'Yoreh De'ah' 158. The Shulhan 'Arukh repeats the same doctrine in

'Hoshen Mishpat' 425").

848. Shahak, Jewish History, *supra*.

849. EDMOND PARIS, THE SECRET HISTORY OF THE JESUITS, p. 21 (1975) (quoting *H. Boehmer*, professor at the University of Bonn, *Les Jesuits* (1910)).

850. J. E. C. SHEPHERD, THE BABINGTON PLOT, Wittenburg Publications, p. 118, 1987.

851. J. E. C. SHEPHERD, THE BABINGTON PLOT, Wittenburg Publications, 1987.

852. *Id.* at p. 104-117. *See also* COLLIER'S ENCYCLOPEDIA, volume 9, p. 97 (1991). *See also*, LES GARRETT, WHICH BIBLE CAN WE TRUST?, p. 60 (1982).

853. COLLIER'S ENCYCLOPEDIA, volume 9, p. 620 (1991).

854. COLLIER'S ENCYCLOPEDIA, volume 11, p. 536 (1991).

855. COLLIER'S ENCYCLOPEDIA, volume 12, p. 192 (1991).

856. COLLIER'S ENCYCLOPEDIA, volume 13, p. 550 (1991).

857. COLLIER'S ENCYCLOPEDIA, volume 13, p. 550 (1991).

858. EDMOND PARIS, THE SECRET HISTORY OF THE JESUITS, p. 69 (1975).

859.FOXE'S BOOK OF MARTYRS, edited by
William Byron Forbush,
<http://www.ccel.org/foxe/martyrs/fox117.htm>.

860.Norman Hammond, Archaeology Correspondent,
Expert Views Differ on Jesuit's Role in the Piltdown
Man forgery, *London Times*, July 15, 1980,
[http://www.clarku.edu/~piltdown/map_prim_suspects/
Teilhard_de_Chardin/Chardin_Prosecution/expertsdiff.html](http://www.clarku.edu/~piltdown/map_prim_suspects/Teilhard_de_Chardin/Chardin_Prosecution/expertsdiff.html) (website address current as of February 28,
2005).

861.Ken Ham, *The Lie: Evolution* (1987), *available at*
[http://www.creationists.org/evolutionism-is-a-religion.
html](http://www.creationists.org/evolutionism-is-a-religion.html).

862.Samuel KJBB, *Tares Among The Wheat* (Sequel
to "A Lamp in the Dark"), Published on April 29,
2014, at 39:20 of video,
[https://www.youtube.com/watch?v=-aiHcghIdjM&spfr
eload=5](https://www.youtube.com/watch?v=-aiHcghIdjM&spfreload=5).

863.Israel Shahak, *Jewish History, Jewish Religion:
The Weight of Two Thousand Years* (1994), *available
at*
[http://www.biblebelievers.org.au/jewhis2.htm#Prejudic
e%20and%20Prevarication](http://www.biblebelievers.org.au/jewhis2.htm#Prejudice%20and%20Prevarication).

864.Moses Maiminodes, *The Guide of the Perplexed*
[*Moreh Nevuk'him*], translated by Schlomo Pines
[Chicago: University of Chicago Press, 1963], vol. 2,
pp 618-19 (quoted by Michael Hoffman in *Judaism's
Strange Gods*, at 65 (2002).

865.Bobby O'Connor, *The Racism of Evolution
Theory*, CHARLESTON GAZETTE, June 25, 1998 at
P18. (Quoting CHARLES DARWIN, THE

DESCENT OF MAN (1874)). See also Benno C. Schmidt, *Principle and Prejudice: The Supreme Court and Race in the Progressive Era. Part 1: The Heyday of Jim Crow*, 82 COLUM. L. REV. 444, 453 (1982).

866.Rabbi Shraga Simmons, Ask Rabbi Simmons, Evolution vs. Creation, at http://judaism.about.com/library/3_askrabbi_o/bl_simmons_evolution.htm.

867.Jewish Encyclopedia, Evolution, at <http://www.jewishencyclopedia.com/view.jsp?artid=534&letter=E> (last visited on April 17, 2010).

868.Dennis Bratcher, *The Five Articles of the Remonstrants (1610)*, <http://www.crivoice.org/creedremonstrants.html> (last visited on October 13, 2011).

869.Stephen Tomkins, John Wesley, A Biography, at 168 (2003) (emphasis added).

870.Kenneth Talbot, Gary W. Crampton, D. James Kennedy, *Calvinism, Hyper-Calvinism, & Arminianism: A Workbook*, at 38 (2007).

871.Society of Evangelical Arminians, <http://evangelicalarminians.org/> (last visited on November 28, 2011).

872.Micael Horton, Evangelical Arminians, Option or Oxymoron?, November 28, 2011, <http://www.reformationonline.com/arminians.htm>.

873.Franklin Graham, *Expect Suffering, But Not Forever*, April 27, 2011, Billy Graham Evangelistic Association,

<http://www.billygraham.org/articlepage.asp?articleid=162>.

874.Ken Johnson, *The Gnostic Origins of Calvinism*, at 69-70 (2013).

875.Ken Johnson, *The Gnostic Origins of Calvinism*, at 69-70 (2013).

876.Joseph Flatley, *Flat Earth*, March 21, 2015, <https://www.youtube.com/watch?v=KTjjW2L2png&list=PL8hYGBs2qN3tv0NpSS9y3gzFte8fchZg->

877.Joseph Flatley, *Flat Earth*, March 21, 2015, *supra*.

878.Joseph L. Flatley, *The Earth Is Flat and ‘They’ Don’t Want You to Know*, *The Kernel*, September 20th, 2015, <http://kernelmag.dailydot.com/issue-sections/features-issue-sections/14360/flat-earth-truthers-youtube/>

879.Shulamit Aloni: “It’s a Trick We Always Use,” <http://wideeyecinema.com/?p=3804> (last visited on December 12, 2010).

880.Shulamit Aloni, *Jewish Virtual Library*, <http://www.jewishvirtuallibrary.org/jsource/biography/aloni.html> (last visited on December 12, 2010).

881.ALBERTO RIVERA, *DOUBLE CROSS*, Chick Publications, p. 12, 1981. *See also*, EDWIN A. SHERMAN, *THE ENGINEER CORPS OF HELL*, Library of Congress catalog card # 66-43354, p. 118 (1883); *Congressional Record*, House Bill 1523, contested election case of Eugene C. Bonniwell against Thos. S. Butler, February 15, 1913, at pp. 3215-16; BURKE MCCARTY, *THE SUPPRESSED TRUTH ABOUT THE ASSASSINATION OF ABRAHAM*

LINCOLN, at pp. 14-16.

882. Joseph L. Flatley, The Earth Is Flat and ‘They’ Don’t Want You to Know, The Kernel, September 20th, 2015,
<http://kernelmag.dailydot.com/issue-sections/features-issue-sections/14360/flat-earth-truthers-youtube/>

883. Joseph L. Flatley, Propaganda 2.0: Why Israel and Hamas Are Fighting a War with Rockets and Tweets, The IDF Takes to Social Media in its War on Hamas, The Verge, November 15, 2012,
<http://www.theverge.com/2012/11/15/3649792/israel-hamas-social-networking-twitter-gaza>.

884. Joseph L. Flatley, Realtime War: Israeli Military Liveblogs, Tweets Attack on Hamas, The Verge, November 14, 2012,
<http://www.theverge.com/2012/11/14/3645426/israel-hamas-military-liveblog-tweet-warfare>.

885. George Washington, The World's First Social Media War: Israel v. Hamas, Zero Hedge, November 12, 2012,
<http://www.zerohedge.com/contributed/2012-11-21/israel-winning-war-%E2%80%A6-social-media>.

886. Jonathan Cook, Internet Users Paid to Spread Israeli Propaganda, 21 July 2009, The Electronic Intifada,
<https://electronicintifada.net/content/internet-users-paid-spread-israeli-propaganda/8355>.

887. George Washington, The World's First Social Media War: Israel v. Hamas, Zero Hedge, November 12, 2012,
<http://www.zerohedge.com/contributed/2012-11-21/israel-winning-war-%E2%80%A6-social-media>.

ael-winning-war-%E2%80%A6-social-med...

888.Ali Abunimah, Israeli Students to Get \$2,000 to Spread State Propaganda on Facebook, 4 January 2012, The Electronic Intifada, <https://electronicintifada.net/blogs/ali-abunimah/israeli-students-get-2000-spread-state-propaganda-facebook>.

889.Israel to Pay Students to Defend it Online, Associated Press, USA Today, August 14, 2013, <http://www.usatoday.com/story/news/world/2013/08/14/israel-students-social-media/2651715/>.

890.Robert Carter & Jonathan Sarfati, Why the Universe Does Not Revolve Around the Earth, Refuting Absolute Geocentrism, Creation Ministries International, 12 February 2015, <http://creation.com/refuting-absolute-geocentrism>.

891.Robert Carter & Jonathan Sarfati, *supra*.

892.Dr Robert W. Carter, Creation Ministries International, <http://creation.com/dr-robert-carter> (last visited on October 4, 2015).

893.What We Believe, Creation Ministries International, <http://creation.com/about-us#what we believe>.

894.What We Believe, Creation Ministries International, <http://creation.com/about-us#what we believe>.

895.Robert Carter and Jonathan Sarfati, Flat Earth, and Other Nonsense, Dealing with Ideas That Would Not Exist Were it Not for the Internet, Creation Ministries, February 13, 2016, <http://creation.com/refuting-flat-earth>.

896. Robert Carter and Jonathan Sarfati, Flat Earth, and Other Nonsense, Dealing with Ideas That Would Not Exist Were it Not for the Internet, Creation Ministries, February 13, 2016,
<http://creation.com/refuting-flat-earth>.

897. Robert Carter and Jonathan Sarfati, Flat Earth, and Other Nonsense, Dealing with Ideas That Would Not Exist Were it Not for the Internet, Creation Ministries, February 13, 2016,
<http://creation.com/refuting-flat-earth>.

898. Robert Carter and Jonathan Sarfati, Flat Earth, and Other Nonsense, Dealing with Ideas That Would Not Exist Were it Not for the Internet, Creation Ministries, February 13, 2016,
<http://creation.com/refuting-flat-earth>.

899. Robert Carter and Jonathan Sarfati, Flat Earth, and Other Nonsense, Dealing with Ideas That Would Not Exist Were it Not for the Internet, Creation Ministries, February 13, 2016,
<http://creation.com/refuting-flat-earth>.

900. Robert Carter and Jonathan Sarfati, Flat Earth, and Other Nonsense, Dealing with Ideas That Would Not Exist Were it Not for the Internet, Creation Ministries, February 13, 2016,
<http://creation.com/refuting-flat-earth>.

901. Robert Carter and Jonathan Sarfati, Flat Earth, and Other Nonsense, Dealing with Ideas That Would Not Exist Were it Not for the Internet, Creation Ministries, February 13, 2016,
<http://creation.com/refuting-flat-earth>.

902. Robert Carter and Jonathan Sarfati, Flat Earth, and Other Nonsense, Dealing with Ideas That Would Not Exist Were it Not for the Internet, Creation Ministries, February 13, 2016,
<http://creation.com/refuting-flat-earth>.

903. Robert Carter and Jonathan Sarfati, Flat Earth, and Other Nonsense, Dealing with Ideas That Would Not Exist Were it Not for the Internet, Creation Ministries, February 13, 2016,
<http://creation.com/refuting-flat-earth>.

904. Robert Carter and Jonathan Sarfati, Flat Earth, and Other Nonsense, Dealing with Ideas That Would Not Exist Were it Not for the Internet, Creation Ministries, February 13, 2016,
<http://creation.com/refuting-flat-earth>.

905. Robert Carter and Jonathan Sarfati, Flat Earth, and Other Nonsense, Dealing with Ideas That Would Not Exist Were it Not for the Internet, Creation Ministries, February 13, 2016,
<http://creation.com/refuting-flat-earth>.

906. Creation Research Society, Statement of Belief, <https://www.creationresearch.org/index.php/about-crs/statement-of-belief> (last visited on March 21, 1956).

907. Creation Research Society, Statement of Faith, *supra*.

908. Danny Faulkner, Geocentrism and Creation, Answers in Genesis, August 1, 2001, <https://answersingenesis.org/creationism/arguments-to-avoid/geocentrism-and-creation/>.

909. Glenn Elert, The Scriptural Basis for a Geocentric
Cosmology, 25 April 1999,
<http://hypertextbook.com/eworld/geocentric.shtml>.

910. Glenn Elert, supra.

911. Glenn Elert, supra.

912. The Kent Hovind Flat Earth Challenge, August 2,
2015,
<https://www.youtube.com/watch?v=gqYqs2R4wDA>.

913. The Kent Hovind Flat Earth Challenge, August 2,
2015,
<https://www.youtube.com/watch?v=gqYqs2R4wDA>.

 pdfelement

Remove Watermark Now

 pdfelement

Remove Watermark Now

 pdfelement

Other books available from Great Mountain Publishing®

Antichrist: The Beast Revealed

Edward Hendrie

ISBN-13: 978-0-9832627-8-7

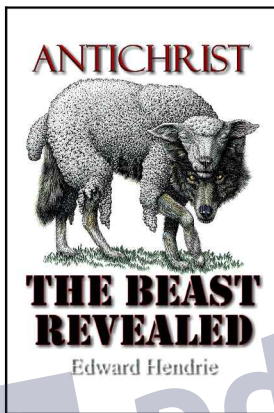

The antichrist is among us, here and now. This book proves it by comparing the biblical prophecies about the antichrist with the evidence that those prophecies have been fulfilled. This book documents the man of sin's esoteric confession that he is the antichrist. You will learn how the antichrist has changed times and laws as prophesied by Daniel, and how he is today sitting in the temple of God, "shewing himself that he is God," in fulfillment of Paul's prophecy in 2 Thessalonians 2:4. The beast of Revelation has come into the world, "after the working of Satan with all power and signs and lying wonders, and with all deceivableness of unrighteousness," as prophesied in 2 Thessalonians 2:10. The antichrist's adeptness as a hypocrite is the reason for his evil success. Indeed, to be the antichrist, his evil character must be concealed beneath a facade of piety. "And no marvel; for Satan himself is transformed into an angel of light. Therefore it is no great thing if his ministers also be transformed as the ministers of righteousness; whose end shall be according to their works." 2 Corinthians 11:14-15. The key to revealing the identity of the antichrist is to uncover his hypocrisy. Because the hypocrisy of the antichrist is so extreme, those who have been hoodwinked by his religious doctrines will be shocked to learn of it. This book exposes the concealed iniquity of the antichrist and juxtaposes it against his publicly proclaimed false persona of righteousness, thus bringing into clear relief that man

of sin, the son of perdition, who is truly a ravening wolf in sheep's clothing, speaking lies in hypocrisy. See Matthew 7:15 and 1 Timothy 4:1-3.

9/11-Enemies Foreign and Domestic

Edward Hendrie

ISBN-13: 978-0983262732

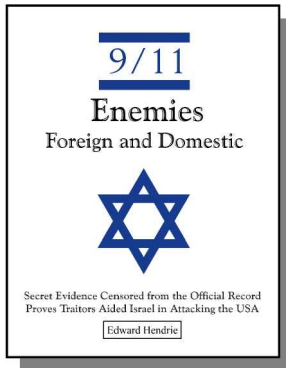

9/11-Enemies Foreign and Domestic proves beyond a reasonable doubt that the U.S. Government's conspiracy theory of the attacks on September 11, 2001, is a preposterous cover story. The evidence in 9/11-Enemies Foreign and Domestic has been suppressed from the official government reports and censored from the mass media. The evidence proves that powerful Zionists ordered the 9/11 attacks, which were perpetrated by

Israel's Mossad, aided and abetted by treacherous high officials in the U.S. Government. 9/11-Enemies Foreign and Domestic identifies the traitors by name and details their subversive crimes. There is sufficient evidence in 9/11-Enemies Foreign and Domestic to indict important officials of the U.S. Government for high treason. The reader will understand how the U.S. Government really works and what Sir John Harrington (1561-1612) meant when he said: "Treason doth never prosper: what's the reason? Why if it prosper, none dare call it treason." There are millions of Americans who have taken an oath to defend the U.S. Constitution against all enemies foreign and domestic. The mass media, which is under the control of a disloyal cabal, keeps those patriotic Americans ignorant of the traitors among them. J. Edgar Hoover, former Director of the FBI, explained: "The individual is handicapped by coming face-to-face with a conspiracy so monstrous-he simply cannot believe it exists." 9/11-Enemies Foreign and Domestic erases any doubt about the existence of the monstrous conspiracy described by Hoover and arms the reader with the knowledge required to save our great nation. "My people

are destroyed for lack of knowledge." Hosea 4:6.

Solving the Mystery of BABYLON THE GREAT

Edward Hendrie

ISBN-13: 978-0983262701

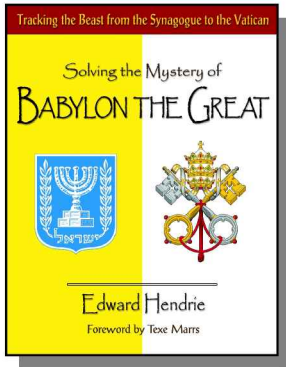

"Attorney and Christian researcher Edward Hendrie investigates and reveals one of the greatest exposés of all time. . . a book you don't want to miss. Solving the Mystery of Babylon the Great is packed with documentation. Never before have the crypto-Jews who seized the reins of power in Rome been put under such intense scrutiny." Texe Marrs, *Power of Prophecy*. The evidence presented in this book leads to the

ineluctable conclusion that the Roman Catholic Church was established by crypto-Jews as a false "Christian" front for a Judaic/Babylonian religion. That religion is the core of a world conspiracy against man and God. That is not a conspiracy theory based upon speculation, but rather the hard truth based upon authoritative evidence, which is documented in this book. Texe Marrs explains in his foreword to the book: "Who is Mystery Babylon? What is the meaning of the sinister symbols found in these passages? Which city is being described as the 'great city' so full of sin and decadence, and who are its citizens? Why do the woman and beast of Revelation seek the destruction of the holy people, the saints and martyrs of Jesus? What does it all mean for you and me today? Solving the Mystery of Babylon the Great answers these questions and more. Edward Hendrie's discoveries are not based on prejudice but on solid evidence aligned forthrightly with the 'whole counsel of God.' He does not condone nor will he be a part of any project in which Bible verses are taken out of context, or in which scriptures are twisted to mean what they do not say. Again and again you will find that Mr. Hendrie documents his assertions, backing up what he says with historical facts and proofs. Most important is that he buttresses his findings

with scriptural understanding. The foundation for his research is sturdy because it is based on the bedrock of God's unshakeable Word."

The Anti-Gospel

Edward Hendrie

ISBN-13: 978-0983262749

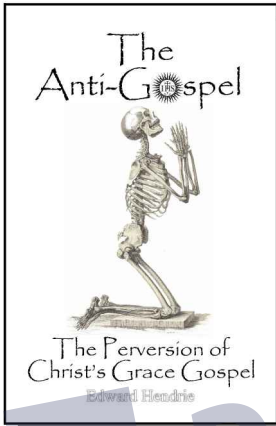

Edward Hendrie uses God's word to strip the sheep's clothing from false Christian ministers and expose them as ravening wolves preaching an anti-gospel. The anti-gospel is based on a myth that all men have a will that is free from the bondage of sin to choose whether to believe in Jesus. The Holy Bible, however, states that all men are spiritually dead and cannot believe in Jesus unless they are born again of the Holy Spirit. Ephesians 2:1-7; John 3:3-8. God has chosen his elect to be saved by his grace through faith in Jesus Christ. Ephesians 1:3-9; 2:8-10. God imbues his elect with the faith needed to believe in Jesus. Hebrews 12:2; John 1:12-13. The devil's false gospel contradicts the word of God and reverses the order of things. Under the anti-gospel, instead of a sovereign God choosing his elect, sovereign man decides whether to choose God. The calling of the Lord Jesus Christ is effectual; all who are chosen for salvation will believe in Jesus. John 6:37-44. The anti-gospel has a false Jesus, who only offers the possibility of salvation, with no assurance. The anti-gospel blasphemously makes God out to be a liar by denying the total depravity of man and the sovereign election of God. All who preach that false gospel are under a curse from God. Galatians 1:6-9.

Bloody Zion*Edward Hendrie*

ISBN-13: 978-0983262763

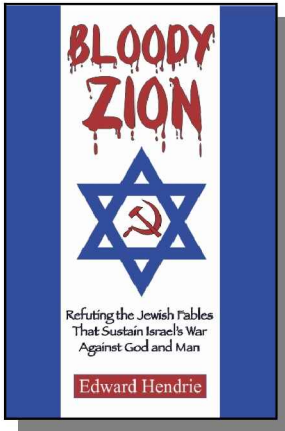

Jesus told Pontius Pilate: "My kingdom is not of this world." John 18:36. God has a spiritual Zion that is in a heavenly Jerusalem. Hebrews 12:22; Revelation 21:10. Jesus Christ is the chief corner stone laid by God in Zion. 1 Peter 2:6. Those who believe in Jesus Christ are living stones in the spiritual house of God. 1 Peter 2:5; Ephesians 2:20-22. Believers are in Jesus and Jesus is in believers. John 14:20; 17:20-23. All who are elected by God to believe in Jesus Christ are part of the heavenly

Zion, without regard to whether they are Jews or Gentiles. Romans 10:12. Satan is a great adversary of God, who has created his own mystery religions. During the Babylonian captivity (2 Chronicles 36:20), an occult society of Jews replaced God's commands with Satan's Babylonian dogma. Their new religion became Judaism. Jesus explained the corruption of the Judaic religion: "Howbeit in vain do they worship me, teaching for doctrines the commandments of men." Mark 7:7. Jesus revealed the Satanic origin of Judaism when he stated: "Ye are of your father the devil, and the lusts of your father ye will do." John 8:44. Babylonian Judaism remains the religion of the Jews today. Satan has infected many nominal "Christian" denominations with his Babylonian occultism, which has given rise to "Christian" Zionism. "Christian" Zionism advocates a counterfeit, earthly Zion, within which fleshly Jews take primacy over the spiritual church of Jesus Christ. This book exposes "Christian" Zionism as a false gospel and subversive political movement that sustains Israel's war against God and man.

Murder, Rape, and Torture in a Catholic Nunnery

Edward Hendrie

ISBN-13: 978-1-943056-00-2

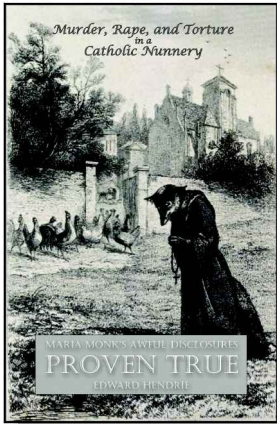

There has probably not been a person more maligned by the powerful forces of the Roman Catholic Church than Maria Monk. In 1836 she published the famous book, *Awful Disclosures of the Hotel Dieu Nunnery of Montreal*. In that book, she told of murder, rape, and torture behind the walls of the cloistered nunnery. Because the evidence was verifiably true, the Catholic hierarchy found it necessary to fabricate evidence and suborn perjury in an attempt to destroy the credibility of Maria Monk.

The Catholic Church has kept up the character assassination of Maria Monk now for over 175 years. Even today, there can be found on the internet websites devoted to libeling Maria Monk. Edward Hendrie has examined the evidence and set it forth for the readers to decide for themselves whether Maria Monk was an impostor, as claimed by the Roman Catholic Church, or whether she was a brave victim. An objective view of the evidence leads to the ineluctable conclusion that Maria Monk told the truth about what happened behind the walls of the Hotel Dieu Nunnery of Montreal. The Roman Catholic Church, which is the most powerful religious and political organization in the world, has engaged in an unceasing campaign of vilification against Maria Monk. Their crusade against Maria Monk, however, can only affect the opinion of the uninformed. It cannot change the evidence. The evidence speaks clearly to those who will look at the case objectively. The evidence reveals that the much maligned Maria Monk was a reliable witness who made awful but accurate disclosures about life in a cloistered nunnery.

What Shall I Do to Inherit Eternal Life?

Edward Hendrie

ISBN-13: 978-0983262770

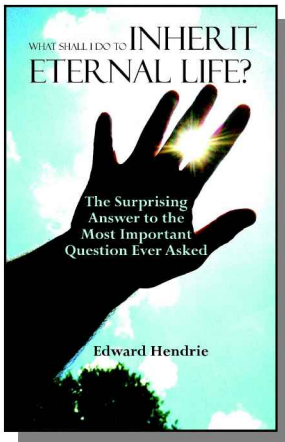

A certain ruler posed to Jesus the most important question ever asked: “Good Master, what shall I do to inherit eternal life?” (Luke 18:18) The man came to the right person. Jesus is God, and therefore his answer to that question is authoritative. This book examines Jesus’ surprising answer and definitively explains how one inherits eternal life. This is a book about God’s revelation to man. Except for the Holy Bible, this is the most important book you will ever read.

Rome’s Responsibility for the Assassination of Abraham Lincoln, With an Appendix Containing Conversations Between Abraham Lincoln and Charles Chiniquy

Thomas M. Harris

ISBN-13: 978-0983262794

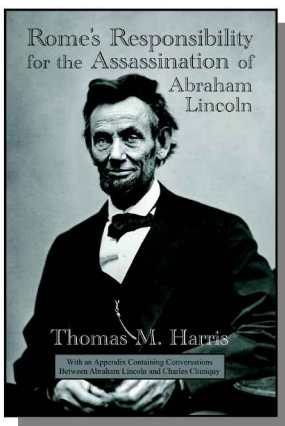

The author of this book, General Thomas Maley Harris, was a medical doctor, who recruited and served as commander of the Tenth West Virginia Volunteers during the Civil War. He rose in rank through meritorious service to become a brigadier general in the Union Army. General Harris established a reputation for faithfulness, industriousness, intelligence, and efficiency. He was noted for his leadership in preparing his troops and

leading them in battle. He was brevetted a major general for "gallant conduct in the assault on Petersburg." After the Civil War, General Harris served one term as a representative in the West Virginia legislature, and was West Virginia's Adjutant General from 1869 to 1870. General Harris was a member of the Military Commission that tried and convicted the conspirators who assassinated President Abraham Lincoln. He had first hand knowledge of the sworn testimony of the witnesses in that trial. This book summarizes the salient evidence brought out during the military trial and adds information from other sources to present before the public the ineluctable conclusion that the assassination of Abraham Lincoln was the work of the Roman Catholic Church. The Roman Catholic Church has been largely successful in suppressing the circulation of this book. This book has never been given a place on bookstore shelves, as it exposed too much for the Roman Catholic hierarchy to tolerate. Any display of this book would bring an instant boycott of the bookstore. It is only now, in the age of the internet, where the marketplace of ideas has been opened wide, that this book can be found by those searching for the truth of who was behind the assassination of Abraham Lincoln.

The above books can be ordered from bookstores and from internet sites, including, but not limited to:

www.anticchristconspiracy.com

www.lulu.com

www.911enemies.com

www.mysterybabylonthegreat.net

www.antigospel.com

<https://play.google.com>

www.barnesandnoble.com

www.amazon.com

Edward Hendrie

edwardhendrie@gmail.com

Remove Watermark Now

 pdfelement

Remove Watermark Now

 pdfelement